

InfoPrint 6500-V Line Matrix Printers



InfoPrint Solutions Company

User's Manual Cabinet and Pedestal Models

InfoPrint 6500-V Line Matrix Printers



InfoPrint Solutions Company

User's Manual Cabinet and Pedestal Models

Note:

Before using this information and the product it supports, read the information in "Safety and environmental notices" on page xi and "Notices" on page 289.

First edition (January 2008)

| This edition applies to the InfoPrint 6500-V Line Matrix Printers and to all subsequent releases of these products
| until otherwise indicated in new releases or technical newsletters, and replaces the following publication: *Infoprint*
| *6500 Line Matrix Printers: User's Manual Cabinet and Pedestal Models*, S544-5957-01.

Internet

Visit our home page: <http://www.infoprint.com>

You can send comments by e-mail to printpub@us.ibm.com or by mail to:

InfoPrint Solutions Company, LLC
6300 Diagonal Hwy 002J
Boulder, CO 80301-9270
U.S.A.

© Copyright InfoPrint Solutions Company 2005, 2008. All rights reserved.

Contents

Figures	vii
--------------------------	------------

Tables	ix
-------------------------	-----------

Safety and environmental notices	xi
---	-----------

About This User's Manual	xiii
---	-------------

Notes And Notices	xiii
-----------------------------	------

Conventions In This User's Manual	xiii
---	------

Related Documents	xiv
-----------------------------	-----

Chapter 1. Printer Overview 1

The InfoPrint 6500 Printer Family	1
---	---

How To Identify The Printer	2
---------------------------------------	---

RibbonMinder	3
------------------------	---

Standard Capabilities	4
---------------------------------	---

Optional Features.	7
----------------------------	---

Protocols and Emulations	9
------------------------------------	---

Graphics Enhancements	9
---------------------------------	---

Taking Care of Your Printer	10
---------------------------------------	----

Chapter 2. Installation, Attachment, and Configuration Overview 11

Before You Begin	13
----------------------------	----

Power Requirements	13
------------------------------	----

Select a Site	13
-------------------------	----

Printer Dimensions	14
------------------------------	----

Printer Component Locations	16
---------------------------------------	----

Chapter 3. Configuring the Printer 19

Overview	19
--------------------	----

The Configurations	19
------------------------------	----

Active Versus Saved Configurations	20
--	----

The Configuration Main Menu	20
---------------------------------------	----

Using the Operator Panel.	23
-----------------------------------	----

Program Mode	27
------------------------	----

Unlocking The Program Mode	27
--------------------------------------	----

Locking The Program Mode.	28
-----------------------------------	----

Entering Program Mode	28
---------------------------------	----

Printing the Current Configuration	28
--	----

Changing Parameters	30
-------------------------------	----

Saving Your Configuration in a Custom Set.	32
--	----

Loading Custom Sets or Factory Default Values	35
---	----

Changing the Power On Configuration	37
---	----

Chapter 4. The Configuration Menus 39

Configuration Overview	39
----------------------------------	----

Main Menu	40
---------------------	----

Quick Setup Menu	42
----------------------------	----

Printer Control Menu	45
--------------------------------	----

Interface Selection	47
-------------------------------	----

Display Language	47
----------------------------	----

Print Direction	47
---------------------------	----

Hex Print Mode	48
--------------------------	----

Power On State	48
--------------------------	----

Paper Jam Detection	48
-------------------------------	----

Forms Speed	48
-----------------------	----

Set Platen at BOF	49
-----------------------------	----

Shuttle Timeout	49
---------------------------	----

Energy Saver Timer.	49
-----------------------------	----

OCR Font Density	50
----------------------------	----

Eject/Restore	50
-------------------------	----

PTR Setup Option	51
----------------------------	----

File System	51
-----------------------	----

Power Stacker	52
-------------------------	----

Auto Elevator	52
-------------------------	----

Printer Management Port.	52
----------------------------------	----

Top Exit Tear Distance.	52
---------------------------------	----

Ribbon End Point	53
----------------------------	----

Ribbon Action	53
-------------------------	----

Configuration Management Menu.	54
--	----

Recall Custom Set	55
-----------------------------	----

Save Current Values	56
-------------------------------	----

Delete Custom Set	56
-----------------------------	----

Change Power On Set.	56
------------------------------	----

Protect Custom Sets	56
-------------------------------	----

Print Custom Set Values	56
-----------------------------------	----

Config Key Default.	57
-----------------------------	----

Name Custom Sets	57
----------------------------	----

Reset Custom Set Names.	57
---------------------------------	----

Twinax Interface Menu	58
---------------------------------	----

Print Language	60
--------------------------	----

Print Character Table	60
---------------------------------	----

Active Print Language.	60
--------------------------------	----

Twinax Printer Emulation	60
------------------------------------	----

Printer Address	60
---------------------------	----

World Trade	61
-----------------------	----

Cancel Buffers	61
--------------------------	----

Early Print Complete	61
--------------------------------	----

Hex Transparent Control	62
-----------------------------------	----

Undefined Char Report	63
---------------------------------	----

Undefined Char Sub	63
------------------------------	----

Load Alt Char Option	63
--------------------------------	----

LAC Approximation	63
-----------------------------	----

Print Text Direction.	64
-------------------------------	----

Override Host	64
-------------------------	----

Format Control	64
--------------------------	----

Maximum Printable Width	65
-----------------------------------	----

Hex Print Mode	65
--------------------------	----

C/T Hotport	65
-----------------------	----

Coax Interface Menu	67
-------------------------------	----

Print Language	69
--------------------------	----

Print Character Table	69
---------------------------------	----

Active Print Language.	69
--------------------------------	----

PA1	69
---------------	----

PA2	70
---------------	----

Buffer Reprint	70
--------------------------	----

Early Print Complete	70
--------------------------------	----

SCS Buffer Control	71
------------------------------	----

Cancel Buffers	71	Default WEP Key	112
Hex Transparent Control	71	WEP Key Format	112
Mono/Dual Case	72	WEP Key Width	112
Undefined Char Sub	72	WEP Key BYTE1 through BYTE13	112
Print Text Direction.	72	Reset WEP Keys	112
Image Buffer Size	73	Wireless Kerberos	113
Intervention Required	73	Kerberos Enable	113
Compatibility Options.	73	Kerberos Password	114
Translate Table	73	Reset Kerberos Password	114
Override Host	73	KDC Port Number	114
Format Control	74	Clock Skew	114
C/T Hotport	74	Ticket Lifetime	114
Maximum Printable Width	75	Renew Lifetime.	114
Hex Print Mode	75	Wireless LEAP	115
Compatibility Options Menu	76	Authentication Method	115
5250 Interface Menu	80	LEAP Username	116
Print Language	82	Reset LEAP User	116
Print Character Table	82	LEAP Password	116
Active Print Language.	82	Reset LEAP Password	116
Hex Transparent Control	82	Parallel Interface Menu	117
Undefined Char Reporting	83	Interface Type	117
Undefined Char Sub	84	PC Parallel	117
Print Text Direction.	84	Dataproducts	117
Override Host	84	IEEE 1284	117
Format Control	85	Parallel Hotport	118
Maximum Printable Width	85	PC Parallel Menu	119
C/T Hotport	85	Dataproducts Menu	122
3270 Interface Menu	87	IEEE 1284	125
Print Language	89	Serial Interface Menu.	127
Print Character Table	89	Interface Type	128
Active Print Language.	89	Data Protocol	128
Early Print Complete	89	Baud Rate	128
Hex Transparent Control	89	Data Bits	128
Mono/Dual Case	90	Stop Bits	128
Undefined Char Substitution	91	Parity	129
Print Text Direction.	91	Data Terminal Ready	129
Intervention Required	91	Request to Send	130
Override Host	92	Buffer Size in Kbytes	130
Format Control	92	Poll Character	130
C/T Hotport	92	One Char Enquiry.	130
Maximum Printable Width	93	Serial Hotport	131
Compatibility Options Menu	94	Framing Errors	132
Network Setup Menu	98	Emulation Configuration Menu	133
Adapter Address Submenu	99	Active Emulation	134
Adapter Parameters Submenu.	100	ASCII Printer Emulation.	134
Ethernet Address Submenu.	104	Printer Emulation Configuration	134
Ethernet Parameters Submenu.	105	Print Format.	134
Wireless Address Menu	108	IPDS Feature	134
Wireless Parameters Menu	109	Configuration	134
Signal Strength	110	IPDS Parameters	135
SSID Name	110	IPDS Configuration Menu	135
Reset SSID Name	110	ANSI	142
Operation Mode	110	CPI/LPI Select	144
Minimum Transfer Rate	110	Font Attributes	144
Channel	110	Page Format.	146
Antenna Diversity	111	IGP Feature (PGL).	150
Preamble	111	Configuration	150
Power Management	111	IGP Parameters.	150
Transmit Power.	111	IGP Emulation Menu.	151
International Mode	111	Code V Feature (VGL)	156
Authentication Method	111	Configuration	156

Code V Parameters	156
Code V Emulation Menu	157
Printer Emul Config Menu	166
Proprietary III XL Emulation Menu	167
Epson Emulation Menu	169
pSeries Emulation Menu	171
pSeries XQ Emulation Menu	175
Serial Matrix Emulation Menu.	178
Print Format Menu	181
Operator Print Tests Menu	189
Printer Demonstration	189
Print Error Log	189
Print Ribbon Log	189
Ripple Print	190
All E's	190
All H's	190
All E's + FF	190
Underlines	190
Adapter Test Page	190
Ethernet Test Page	190
Clear Error Log	190
Printer Information Menu	191
Installed Memory	191
Power On Time	191
Printing Time	191
Print Strokes	192
11 Inch Pages	192

Chapter 5. Printer Interfaces 193

Overview	193
RS-232 and RS-422 Serial Interfaces	194
RS-232	194
RS-422	195
RS-232 Serial Interface Protocols	195
RS-232 and RS-422 Serial Interface Protocols	196
RS-232 and RS-422 Serial Interface Error Handling	196
RS-232 and RS-422 Serial Interface Configuration	197
PC Parallel Interface	198
PC Parallel Interface Signals	199
PC Parallel Interface Configuration	199
Dataproducts Parallel Interface	200
Dataproducts Parallel Interface Signals	201
Dataproducts Parallel Interface Configuration	201
IEEE 1284 Parallel Interface	202
Operating Modes	202
The Negotiation Phase	203
Signals	203
Terminating Resistor Configurations	206

Chapter 6. Reprogramming The Security Key 209

How To Reprogram The Security Key	209
---	-----

Chapter 7. Routine Service and Diagnostics 211

Overview	211
Cleaning Requirements	211
Exterior Cleaning	211

Interior Cleaning	212
Printer Self-Tests	215
Running the Printer Self-Tests	216
Hex Code Printout	217
Fault Messages	221
Fault Correction Procedure	221

Appendix A. Printer Specifications 251

Ribbon Specifications	251
Ordering Ribbons	251
6500-vxx Models	251
Paper Specifications	254
Paper	254
Labels	255
Printer Dimensions and Weight	255
Cabinet Models	255
Pedestal Models	255
Environmental Characteristics	256
Temperature	256
Relative Humidity	256
Acoustic Noise Level	256
Electrical Characteristics	257
Input Voltage	257
Power Consumption	257
Interfaces	260
Cables	260
Printing Rates	261

Appendix B. A Quick Look at Line Matrix Printing 263

Character Formation	263
Printing Speed	265

Appendix C. Host Attachment 267

Compatibility and Limitations	268
Compatibility	268
Limitations	270

Appendix D. Attaching Host Systems to a Coax/Twinax Printer 273

Attaching Printer to an IBM System i or zSeries Host System	273
Attaching Printer to an IBM System i Host System	273
Attaching Printer to an IBM System i with Twinax Interface	273
Changing Your IBM System i Printer Configuration	274
Attaching Printer to Remote Control Unit with Twinax Interface	276
Attaching Printer to zSeries Systems	277
Types of Installation covered for MVS/JES2	277
6500-LU1-SCS-Local SNA 3174 Control Unit	277
6500-LU1-SCS-Remote SNA 3174 Control Unit	279
6500-LU3-DSE-Local SNA 3174 Control Unit	281
6500-LU3-DSE-Remote SNA 3174 Control Unit	282
6500-LU0-DSC-Local Non-SNA 3174 Control Unit	284
Attaching Printer to VM Host System	285
SNA Attachment	285
Non-SNA Attachment	286

Physical and Logical Unit Types 286
 Physical Unit (PU) types and examples 286
 Summary of LU Types and Representative IBM
 Products 287

Notices 289
 Product recycling and disposal 291
 Trademarks 291

Communication statements 293

Glossary 297
 References 297
 Terms 297

Index 303

Figures

1. Printer Model Number Interpretation	2	33. Adapter Address Submenu	99
2. Exploded View of Cabinet Model Printer Dimensions	14	34. Adapter Parameters Submenu	100
3. Exploded View of Cabinet Model with Power Paper Stacker Printer Dimensions	15	35. Ethernet Address Submenu	104
4. Exploded View of Pedestal Model Printer Dimensions	16	36. Ethernet Parameters Submenu	105
5. 6500 Printer Component Locations with the Ribbon Spools Exploded Above	17	37. Wireless Address Menu	108
6. Pedestal Model Printer Component Locations with Open Access Cover and Ribbon Spools Exploded Above	18	38. Wireless Parameters Menu	109
7. Configuration Main Menu	21	39. Wireless Kerberos Menu	113
8. Configuration Main Menu (continued)	22	40. Wireless LEAP Menu	115
9. The Operator Panel	23	41. Parallel Interface Menu	117
10. Configuration Management Menu - Print Custom Set Values	29	42. PC Parallel Menu	119
11. Printer Control Menu - Print Direction	30	43. Dataproducts Menu	122
12. Configuration Management Menu - Save Current Values	32	44. IEEE 1284 Menu	125
13. Configuration Management Menu - Recall Custom Sets	35	45. Serial Interface Menu	127
14. Configuration Management Menu - Change Power On Set	37	46. Emulation Configuration Menu	133
15. 6500 Series Main Menu Configuration.	40	47. IPDS Configuration Menu	135
16. 6500 Series Main Menu Configuration (continued).	41	48. IPDS Configuration Menu - Print Language	136
17. Quick Setup Menu	42	49. ANSI Emulation Menu	142
18. Quick Setup Menu (continued)	43	50. ANSI Emulation Menu - Font Attributes, Character Set, and Page Format Menus	143
19. Printer Control Menu	45	51. IGP Emulation Menu	151
20. Printer Control Menu (continued)	46	52. Code V Emulation Menu.	157
21. Configuration Management Menu	54	53. Code V Emulation Menu - Graphic Options	158
22. Twinax Interface Menu.	58	54. Printer Emulation Configuration Menu	166
23. Twinax Interface Menu - Print Language	59	55. Proprinter III XL Emulation Menu	167
24. Coax Interface Menu	67	56. Epson Emulation Menu	169
25. Coax Interface Menu - Print Language	68	57. pSeries Emulation Menu	171
26. Compatibility Options Menu.	76	58. pSeries Emulation Menu - Print Language	172
27. 5250 Interface Menu	80	59. pSeries XQ Emulation Menu	175
28. 5250 Interface Menu - Print Language.	81	60. Serial Matrix Emulation Menu	178
29. 3270 Interface Menu	87	61. Print Format Menu	181
30. 3270 Interface Menu - Print Language.	88	62. Top of Line and Bottom of Line Text Positions	187
31. Compatibility Options Menu.	94	63. Operator Print Tests Menu	189
32. Network Setup Menu	98	64. Printer Information Menu	191
		65. Resistor Locations	206
		66. Inserting the SPX into the Debug Port	209
		67. Interior Components of the Cabinet Models	213
		68. Interior Components of the Pedestal Models with Ribbon Spool Above	214
		69. Sample ASCII Hex Code Printout.	219
		70. Sample Coax Hex Code Printout	220
		71. Sample Twinax Hex Code Printout	221
		72. Typical Character Formation	263
		73. Line Matrix Printing	264

Tables

1. The InfoPrint 6500 Printer Family	2	8. Dataproducts Parallel Interface Connector Pin Assignments (with a 50-pin AMP HDH-20 Data Cable Connector)	200
2. Maximum Interface Connection Cable Length	14	9. 1284 Signals	203
3. Form Width	147	10. Terminating Resistor Configurations	206
4. CPI Settings	184	11. Fault Messages	222
5. 6500-v20 RS-232 Serial Interface Connector Pin Assignments	194	12. 6500 Nominal Print Rates (1 of 2).	261
6. RS-422 Serial Interface Connector Pin Assignments	195	13. 6500 Nominal Print Rates (2 of 2).	261
7. Printer PC Parallel Interface Connector Pin Assignments	198	14. Operating System Report	268

Safety and environmental notices



- | | |
|-----|---|
| <1> | Before powering on the printer ensure the printer is plugged into an appropriate power source. Refer to Chapter 2, "Installation, Attachment, and Configuration Overview," on page 11 for information on the proper source. |
| <2> | Switch off the printer power and unplug the printer power cord before cleaning the printer. |
| <3> | Do not connect or disconnect any communication port, teleport, attachment connector, or power cord during an electrical storm. |
| <5> | Power off the printer and disconnect the power cord before connecting or disconnecting any communication port, teleport, or attachment cable connector. |

CAUTION:

This product is equipped with a 3-wire power cord and plug for the user's safety. Use this power cord in conjunction with a properly grounded electrical outlet to avoid electrical shock.

About This User's Manual

This *User's Manual* is designed so that you can quickly install and configure your InfoPrint® 6500 printer.

Notes And Notices

For your safety and to protect valuable equipment, it is very important that you read and comply with all information noted in the following section:



<#>

DANGER:

The word Danger next to the lightning slash indicates the presence of a hazard that could cause death or serious personal injury. Danger and Caution notices are numbered to help you find the translated versions in the *InfoPrint 6500 Line Matrix Printer: Safety Information*.



<#>

CAUTION:

The word Caution next to the exclamation point (!) indicates the presence of a hazard that could cause moderate or minor personal injury.



<#>

CAUTION:

The word Caution next to this symbol indicates a part or assembly that is hot enough to burn you.

Attention: The word Attention indicates the possibility of damage to a program, device, system, or data.

IMPORTANT: The word Important indicates information vital to proper operation of the printer.

Note: A note gives you helpful information and tips about printer operation and maintenance.

Conventions In This User's Manual

Key names, indicator names, and messages that appear on the operator panel display are capitalized as they actually appear on the printer. Key names are shown in bold.

Example: Press the **CLEAR** key, then press the **ON LINE** key.

Quotation marks (“ ”) indicate messages on the Liquid Crystal Display (LCD).

Example: Press the **ON LINE** key. “OFFLINE” appears on the LCD.

Related Documents

- *InfoPrint 6500 Coax/Twinax Programmer's Reference Manual* – Covers the host control codes and character sets for the Coax and Twinax emulations.
- *InfoPrint 6500 ASCII Programmer's Reference Manual* – Covers the host control codes for the LinePrinter Plus emulation.
- *InfoPrint 6500 IGP Programmer's Reference Manual* – Provides information used with the optional IGP emulation enhancement feature.
- *InfoPrint 6500 Code V Programmer's Reference Manual* – Provides information used with the optional Code V emulation enhancement feature.
- *InfoPrint 6500 ANSI Programmer's Reference Manual* – Provides host control codes and character sets for the ANSI emulation.
- *IPDS Emulation Programmer's Reference Manual* – Provides an overview of Intelligent Printer Data Stream™ (IPDS™) features, commands, and diagnostics.
- *Ethernet Interface User's Manual* – Information about network protocols, configuration, and operation.
- *InfoPrint 6500 Line Matrix Printers: Safety Information* – This manual contains English and translated versions of the InfoPrint 6500 Printer Safety Notices. Warning, Caution, and Danger notices are included.
- *InfoPrint 6500 Line Matrix Printers: Quick Start Guide* - Explains how to unpack and set up the printer.

Chapter 1. Printer Overview

This section provides a general overview of your printer and the conventions used within this manual.

The InfoPrint 6500 Printer Family

The InfoPrint Solutions Company, a Ricoh-IBM joint venture InfoPrint 6500 series consist of 500, 1000, 1500, and 2000 lines per minute (lpm) models and are packaged in various configurations. All of the models offer software versatility and the latest refinements in line matrix printing technology. The print mechanisms are housed in sound-insulated cabinets which make the printer family among the quietest printers in the world. Additionally, your printer has a flexible architecture that allows you to add new features and emulations as they become available.

ASCII is the standard emulation. ASCII includes the Epson FX-1050, Printronix pSeries, pSeries XQ, Serial Matrix and Proprinter III XL emulations. Coax/Twinax, IPDS , ANSI and the IGP/PGL and IGP/VGL graphics enhancement emulations are available as optional upgrades. No matter what emulation is installed, your printer is easy to use. The message display and lights on the control panel communicate with you directly and clearly. You can select every function on your printer at the control panel, or you can send commands from the host computer.

The printer combines the use of Flash, RAM, and nonvolatile RAM for program execution. The Flash is used for all program, font, and emulation storage. New fonts, emulations, or program updates can be downloaded to Flash memory via the parallel or serial interface, or through the Ethernet interface. The RAM is used for buffers, print image storage, and execution variables. The nonvolatile RAM stores configuration, statistics, and internal parameters.

Table 1. The InfoPrint 6500 Printer Family

Model Number	Print Speed	Enclosure	Hammer Bank
6500-v05	500 LPM*	Floor Cabinet	28 Hammers
6500-v5P	500 LPM	Pedestal, Quick Access	28 Hammers
6500-v10	1000 LPM	Floor Cabinet, Power Stacker optional	60 Hammers
6500-v1P	1000 LPM	Pedestal, Quick Access	60 Hammers
6500-v15	1500 LPM	Floor Cabinet, Power Stacker optional	102 Hammers
6500-v20	2000 LPM	Floor Cabinet, Power Stacker optional	156 Hammers

* Lines Per Minute

How To Identify The Printer

The model number of the printer indicates the printer family, rated maximum print speed, and type of enclosure. (See Figure 1.)

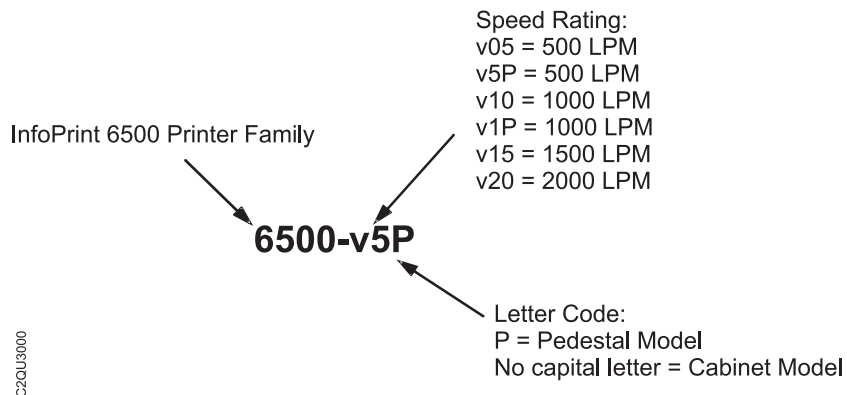

Figure 1. Printer Model Number Interpretation

RibbonMinder

The InfoPrint 6500 has a new feature that automatically monitors and communicates ribbon life. Using a specially barcoded spool, the printer can automatically detect when a new or used ribbon is loaded, and all ribbon properties. With a sophisticated algorithm, the system monitors all jobs printed and automatically updates the remaining ribbon life on the front panel display. This allows the system administrator to have precise control over print quality and consumable costs. The accurate presentation of available ribbon life allows for efficient planning of print jobs. For example, you can install a new ribbon before printing large print jobs.

When the ribbon life gets near the end point, the printer displays a ribbon low message and flashes the indicator light. Printing will continue without interruption. Once the ribbon reaches 0% remaining, the alarm sounds, the indicator light flashes, the display updates, and printing pauses. If a new ribbon is loaded, the system automatically detects the change, clears the condition, and restarts the life at 100%. If it is not convenient to change the ribbon immediately, cycle the printer on and offline and it will resume printing for a few minutes. This should be enough to complete the job. If not, repeat the same procedure indefinitely to extend printing on the same ribbon.

Output Darkness

By default the system is configured to meet most user requirements. However, some applications require that the output remains darker than the nominal set point while some applications are less critical and could tolerate a lighter final image. The system can easily adjust to this variability. A setting under Printer Control, Ribbon End Point is available that allows the user to adjust the final output. The range is as follows:

- Lighter -4 (Default)
- Darker +1 through +6
- Normal
- Lighter -1 through -10

The ribbon life indicator always cycles between 100% and 0%, but if a darker setting is selected, zero will be reached more quickly. If a lighter setting is selected, the system will extend the amount of printing it takes to reach zero.

Ribbon Flipping

In some cases, the application's print pattern is narrow enough where only half of the ribbon is used when printing. In these cases, you can flip the ribbon and use the other half. The RibbonMinder detects the flip and resets the ribbon life to 100%.

Note: It is the user's responsibility to ensure the print pattern is sufficiently narrow to support flipping. If not, the ribbon life may falsely indicate 100% for the flipped ribbon.

Loading a Used Ribbon

You can take ribbons off the printer and reload it at a later time. The ribbon life gauge automatically updates to reflect the correct remaining capacity.

Note: The ribbon must be reloaded back onto the same printer, and in the same orientation as it was removed. If the used ribbon is loaded onto a different printer, or if it is flipped over, it will incorrectly indicate the ribbon as new.

Ribbon Log

The RibbonMinder tracks all used ribbons. This data allows you to monitor how many ribbons and ribbon types have been used on the printer. This data is contained in the ribbon log. To print the ribbon log, see “Print Ribbon Log” on page 189.

Consumable Monitoring With The Printer Management Utility

The RibbonMinder works with the Printer Management Utility (PMU). The PMU allows a system administrator to remotely view the current consumable status of all printers. The PMU can be configured to deliver alerts on all consumable warnings. When a ribbon reaches the low state, the PMU notifies the system administrator remotely via an automated e-mail alert of the low condition. This allows corrective action to be taken before the ribbon reaches its end of life. If the ribbon is not changed, an alert will again be initiated once the ribbon reaches the 0% end point. Refer to your *Printer Management Utility User's Manual* for details.

Standard Capabilities

The InfoPrint 6500 printer family has the following general characteristics:

- A broad range of print speeds in both cabinet and pedestal models
- Support of similar features across the entire product line to allow maximum flexibility in matching the printer to the requirements
- Energy Star compliant

The following sections summarize the standard capabilities of the InfoPrint 6500 printers.

Host Computer Interfaces

- RS 232 Serial
- RS 422 Serial
- PC Parallel
- Dataproducts Parallel
- Ethernet Interface
- IEEE 1284

Coax/Twinax features are available with this printer:

- Coax/Twinax

Printer Emulations

Each emulation provides a different set of configuration menus, control codes, and character sets. The following printer emulations (or protocols) are standard, and selectable at the operator panel:

- Proprinter III XL Emulation
- Epson FX Emulation
- pSeries Printer Emulation
- pSeries XQ Variant Printer Emulation
- Serial Matrix Printer Emulation

Proprinter III XL and Epson FX Emulations: The Proprinter III XL and Epson FX emulations are industry standard printer emulations.

pSeries Printer Emulation: This code system was developed especially for line matrix printers. As line matrix printers became more sophisticated, this code system kept pace by adding codes that fully utilized line matrix printer capabilities.

IMPORTANT: This emulation appears as “pSeries” on the operator panel.

pSeries XQ Variant Printer Emulation: This code system was devised for a series of printers manufactured between 1974 and 1991, that are no longer available.

IMPORTANT: This emulation appears as “pSeries XQ” on the operator panel.

Serial Matrix Printer Emulation: This printer emulation is very similar to the code systems used by an InfoPrint Graphics Printer, but incorporates several systems into one emulation. This emulation enables a line matrix printer to print files coded for a serial matrix printer, and is sometimes referred to as the Serial Matrix collection.

IMPORTANT: This emulation appears as “Serial Matrix” on the operator panel.

Note: Serial matrix refers to the way printer characters are formed. A moving printhead uses pins to form whole characters one at a time and one after the other. The pins print dots according to programmed matrix patterns. Data is sent to the printer through either a serial or parallel interface, but the printhead must receive the data serially to form each character.

An InfoPrint line matrix printer also forms characters with dots in matrix patterns, but it feeds print data in parallel to many hammers mounted on a rapidly oscillating shuttle. The hammers fire simultaneously to print entire lines at a time.

Output Control

The printers have the following output control features:

- Six modes for printing text:
 - Near-Letter Quality (NLQ)
 - Near-Letter Quality San Serif
 - Data Processing (DP)
 - Draft
 - Optical Character Recognition Font A (OCR A)
 - Optical Character Recognition Font B (OCR B)
- OCR A and OCR B support 120 and 180 PEL, with 120 PEL the default value.
- Selectable forms length and width
 - Character attribute specification:
 - Selectable pitch: normal, expanded, and compressed
 - Emphasized (shadow) printing
 - Automatic underlining and overscoring
 - Superscript and subscript printing
 - Double high and wide printing
 - Resident multinational character sets

Graphics and Vertical Formatting

Several graphics and vertical formatting features are available:

- Three built-in graphics generators:
 - Proprinter III XL bit-image graphics
 - Epson FX dot graphics mode
 - pSeries Plot
- Programmable electronic vertical formatting provides rapid vertical paper movement to specified lines for printing repetitive and continuous forms. You can use the following methods:
 - Vertical tabbing in Serial Matrix, Proprinter III XL, and Epson FX emulation modes
 - Electronic Vertical Format Unit (EVFU) in pSeries emulation mode

Built-in Diagnostic Tools

The following diagnostic tools are provided with the printer:

- Comprehensive diagnostic self-tests permanently stored in the printer
- Configuration printout
- Data stream hex code printout

Optional Features

The following features can be ordered and installed on this printer. If you ordered a feature at the time of purchase, the feature may already be installed on your printer. Refer to the documentation shipped with the feature for more details.

For detailed information about these features or for information on ordering a feature, contact your sales representative.

- Coax/Twinax Attachment:

Enables you to attach this printer to IBM® host systems, such as an System i® or zSeries® Host System. This feature also helps you to replace Coax/Twinax printers such as the IBM 3262 Models 3 and 13, IBM 4234 Models 1, 2, and 9, and IBM 5224 Models 1 and 2. This feature can be used with the Intelligent Printer Data Stream (IPDS) feature which is described below.
- InfoPrint Solutions Company Intelligent Printer Data Stream:

Provides the ability to create forms, overlays, and graphics. IPDS also provides compatibility when replacing printers such as the IBM 4234 Models 12 and 11. This feature also supports many versions of the Print Services Facility™ (PSF). This feature requires a Coax/Twinax attachment or Ethernet card attachment.

- Code V:
This is an implementation of the Intelligent Graphics Processor architecture and is used commonly to create graphics for optical character recognition and bar codes. This feature is also designed for those applications which use the Quality Micro Systems, Inc. graphics language, which is often referred to as the QMS Code V Magnum emulation and those applications that use the Code V Graphics Language. The Code V Graphics Language is often referred to as VGL.
- IGP:
This is an implementation of Intelligent Graphics Processor architecture and is used commonly to create graphics for optical character recognition and bar codes. This feature is also designed for those applications which use the Graphics Language, which is often referred to as PGL.
This feature can coexist with the Intelligent Printer Data Stream feature, and/or with either Coax/Twinax feature or can be used on the ASCII models.
- TN5250/TN3270 Emulations:
The TN5250/TN3270 feature enables your printer to communicate with a host system through a Network Interface Card (NIC) using the 5250/3270 datastream. This feature allows you to use an application generated for the Twinax/Coax emulation to be printed through the NIC.
Users who are converting from Twinax to TN5250 may see some differences. Please refer to “Compatibility and Limitations” on page 268 for details.
- ANSI Emulation:
The ANSI option allows you to print files coded for the ANSI (American National Standards Institute) printer control language.
- Network Print Server:
Enables you to attach your printer to Local Area Networks using token-ring or Ethernet protocols. The Network Print Server functions as a workstation server on your network, enabling your users to submit print jobs to your printer.
The Network Print Server provides multiple network protocol support that allows you to submit print jobs from Novell Netware, LAN Server, AIX^{®*}, and other TCP/IP networks.
- Dataproducts Adapter:
Supplies a 50 pin AMP Amplimite HDH-20 data cable connector. This feature is necessary if you are using the Dataproducts parallel protocol.
- Ethernet Interface:
Enables you to attach your printer to Local Area Networks using Ethernet protocols. The Ethernet Interface functions as a workstation server on your network, enabling your users to submit print jobs to your printer.

- **Power Paper Stacker:**
Mechanically directs the paper from the printer to the paper stacking area. This feature provides consistent paper handling with fewer paper jam errors.
- **Input Paper Shelf:**
Pedestal model only. Provides a shelf to hold a box of paper or forms. This is a convenient feature if you need to move the printer often.
- **Pull Out Tray:**
Cabinet model only. A tent tray to hold printed papers or forms that you can pull out for accessibility.
- **Wireless:**
An embedded wireless Ethernet Interface card that allows you to attach printers on a local area network (LAN) rather than attaching them directly to a host system.

Protocols and Emulations

A *protocol* is a set of rules governing the exchange of information between the printer and its host computer. These rules consist of codes that manipulate and print data and allow for machine-to-machine communication. A printer and its host computer must use the same protocol. As used in this manual, *protocol* and *emulation* mean the same thing.

Most impact printers are single ASCII character codes to print text, numbers, and punctuation marks. Some characters, both singularly and in groups are defined as control codes. Control codes instruct the printer to perform specific functions, such as underlining text, print subscripts, setting page margins, etc. The main difference between most printer protocols is in the characters used to create control codes and the ways in which these characters are formatted.

When the printer executes the character and control codes of a particular printer protocol, it is “emulating” that printer. If the printer uses the Proprinter III XL protocol, for example, it is emulating an IBM Proprinter III XL printer. If the printer is using the Epson FX printer protocol, for example, we can also say it is in Epson FX emulation mode.

There are additional emulations that are provided as optional features, such the Code V and IGP emulations. For additional information, refer to “Code V Feature (VGL)” on page 156 and “IGP Feature (PGL)” on page 150.

Graphics Enhancements

The PGL and Code V emulations allow you to create and store forms, generate logos, bar codes, expanded characters, and create other graphics. Alphanumeric and bar code data are added as the form is printed.

These emulations are available as factory-installed or field-installed options. For more information, contact your authorized service representative.

Taking Care of Your Printer

Your printer will produce high print quality jobs if it is well taken care of. Periodic cleaning, handling the printer properly, and using the correct printer supplies such as paper and ink transport media ensures optimum performance. Chapter 7, "Routine Service and Diagnostics" explains how to clean the printer, and printer supplies are listed in Appendix A, "Printer Specifications," on page 251.

Whenever it is necessary to service the printer, remember this important maintenance concept.

- Incorrect closure of the forms thickness lever can lead to smearing, degraded print quality, paper jams, and damage to the platen and shuttle assembly. Never close the forms thickness lever too tightly.

Chapter 2. Installation, Attachment, and Configuration Overview

Note!

Before using this information and the product it supports, read the information and Communication Statements in “Notices” on page 289.



DANGER

<4>	Do not connect or disconnect any communication port, teleport, attachment connector, or power cord during an electrical storm.
<5>	Power off the printer and disconnect the power cord before connecting or disconnecting communication port, teleport, or attachment cable connector.

The following is an overview of the steps you need to complete to successfully install, attach, and configure your printer:

1. Unpack the printer from the shipping package. Follow the instructions provided on the shipping package.
2. Set up the printer, which includes; removing shipping materials, installing the ink transport assembly, ink transport media, ink cartridge, and loading paper. Follow the instructions in *InfoPrint 6500 Line Matrix Printers: Quick Start Guide*.
3. Perform an initial print test by printing the current configuration page as described on page 28.
4. Review the information contained in the *README.1ST* file on the Configuration Utility section on the User’s CD.

Note: The Configuration Utility section contains a *README.1ST* file that describes the contents of the CD, AIX print drivers, and configuration information for replacing existing InfoPrint Solutions Company printers. In addition, there might be another file, called *README.TXT* that contains information that was added after the printer documentation was printed.

5. Attach the printer to the host system and configure the host system to work with the printer.
 - a. For ASCII attachments, follow the instructions in the *InfoPrint 6500 ASCII Programmer's Reference Manual*.
 - b. For Coax/Twinax attachments, follow the instructions in the *InfoPrint 6500 Coax/Twinax Programmer's Reference Manual*.
 - c. If you have ordered the Ethernet Interface, follow the instructions in the *Ethernet Interface User's Manual*.

Note: If you are attaching this printer to an AIX host system, refer to the Configuration Utility section on the User's CD.

6. If you have not already ordered a communications cable, see page 260.
7. Configure the printer to work with host systems and to match your emulation, such as IBM Proprinter III XL. Follow the instructions provided in Chapter 3, "Configuring the Printer," on page 19 and review the information provided in Appendix C, "Host Attachment," on page 267

Note: If you are replacing another printer with this printer, make sure you review the information on the Configuration Utility diskette. The Configuration Utility diskette contains information that will help you configure this printer to match the configuration of the printer you are replacing.

8. Install and/or configure optional features by following instructions provided in the appropriate feature manual. For a brief description of the following optional features, refer to: "IPDS Feature" on page 134, "Code V Feature (VGL)" on page 156, and "IGP Feature (PGL)" on page 150.

Note: For more detailed information about any optional feature, refer to the manual that was shipped with the feature. If you want to order a manual to learn more about these features, see the "Related Documents" on page xiv.

Before You Begin

Read this section carefully before installing and operating the printer. The printer is easy to install. However, for your safety and to protect valuable equipment, perform all the procedures in this section in the order presented.

IMPORTANT: Make sure you have a way to move the printer and shipping pallet. You will need a jack.

Make sure you have adequate room to maneuver the shipping pallet and printer to the location where you plan to install the printer.



CAUTION

<1>	Two people are required to unload the printer from the shipping pallet. The shipping weight of the cabinet model is 129.3 kilograms (285 pounds) or 139 kilograms (306 pounds) if the Power Paper Stacker is installed. The shipping weight of the pedestal model printer is 72.6 kilograms (160 pounds.)
-----	---

Power Requirements

The printer must be connected to a power outlet that supplies 88 to 135 Volts AC or 178 to 271 Volts AC at 50 to 60 Hz. The printer automatically senses and adjusts itself to conform to the correct voltage range.

Primary circuit protection is provided by the power switch, which is also a circuit breaker. Consult an electrician if printer operation affects local electrical lines. See “Electrical Characteristics” on page 257 for additional power specifications.

IMPORTANT: Printer power should be supplied from a separate AC circuit protected at 10 amperes for 100 - 120 volts or 5 amperes for 200 - 240 volts at 50 or 60 Hertz.

Select a Site

Select a printer site that meets all of the following requirements:

- **Cabinet models:** Permits complete opening of the printer cover and both doors of the floor cabinet. Allows at least three feet of clearance behind the printer. (This permits air to circulate freely around the printer and provides access to the paper stacking area.)
- **Pedestal models:** Permits complete opening of the printer cover and good access to the paper areas at the front and rear of the printer.
- Has a standard power outlet that supplies 88-135 Volts AC or 178-270 Volts AC power, at 47 to 63 Hz. The printer automatically senses and adjusts itself to conform to the correct voltage range.
- Is relatively dust-free.
- Has a temperature range of 10 C to 40 C (50 F to 104 F) and a relative humidity from 15% to 90% non-condensing.

- Is located within the maximum allowable cable length to the host computer. This distance depends on the type of interface you plan to use, as shown in Table 2.

Table 2. Maximum Interface Connection Cable Length

Interface Type	Maximum Cable Length
PC Parallel	5 meters (15 feet)
IEEE 1284 Parallel	10 meters (32 feet)
Dataproducts Parallel	12 meters (40 feet)
Serial RS 232	15 meters (50 feet)
Serial RS 422	1220 meters (4000 feet)
Twinax (shielded cable)	1500 meters (4920 feet)
Twisted Pair / Type 3	300 meters (492 feet)
Dataproducts Long Line	150 meters (492 feet)
Coax	1500 meters (4920 feet)
Twisted Pair / Type 3	300 meters (985 feet)
Ethernet 10/100Base-T	100 meters (328 feet)

Printer Dimensions

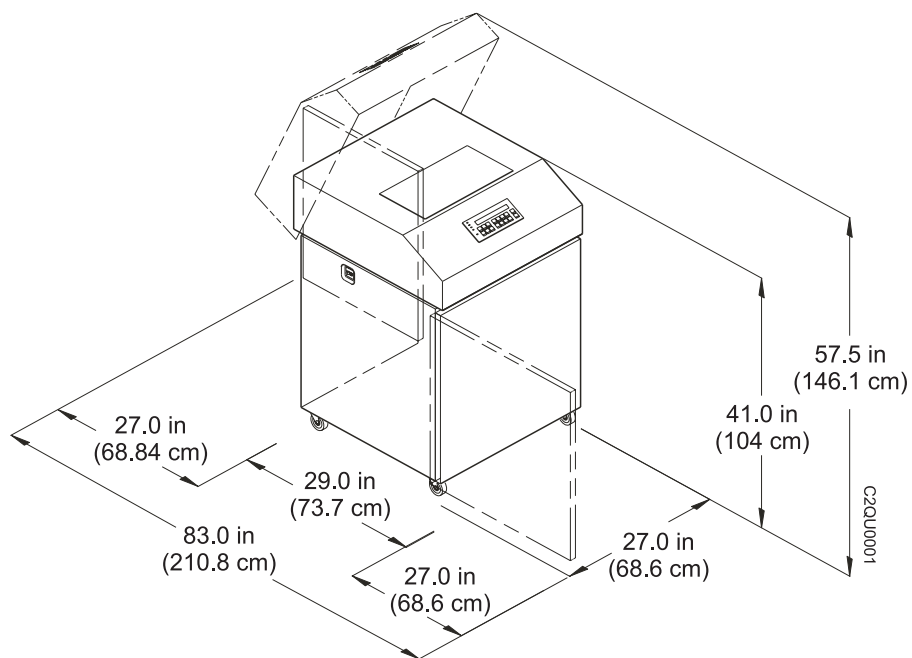

Figure 2. Exploded View of Cabinet Model Printer Dimensions

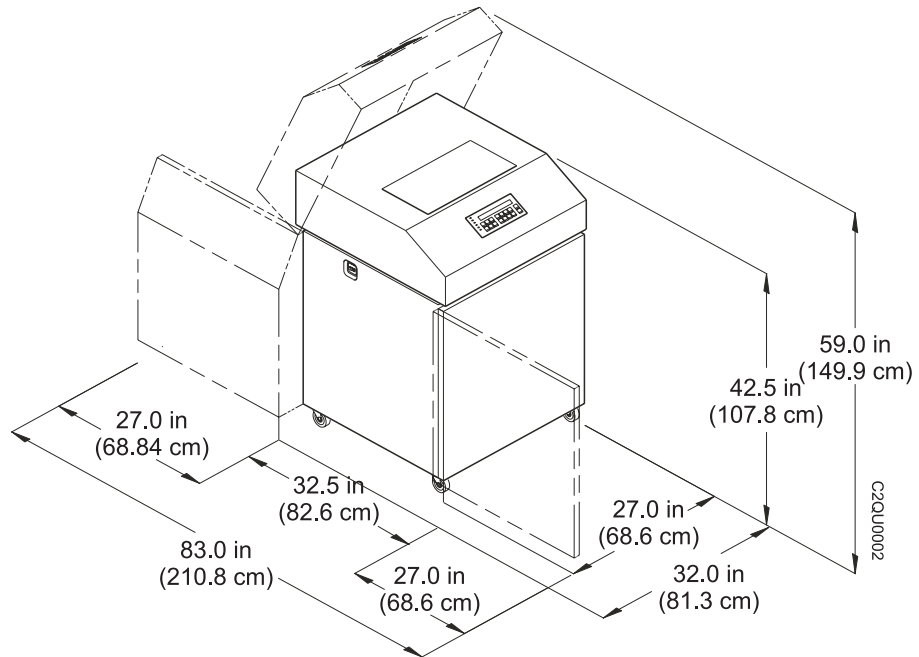

Figure 3. Exploded View of Cabinet Model with Power Paper Stacker Printer Dimensions

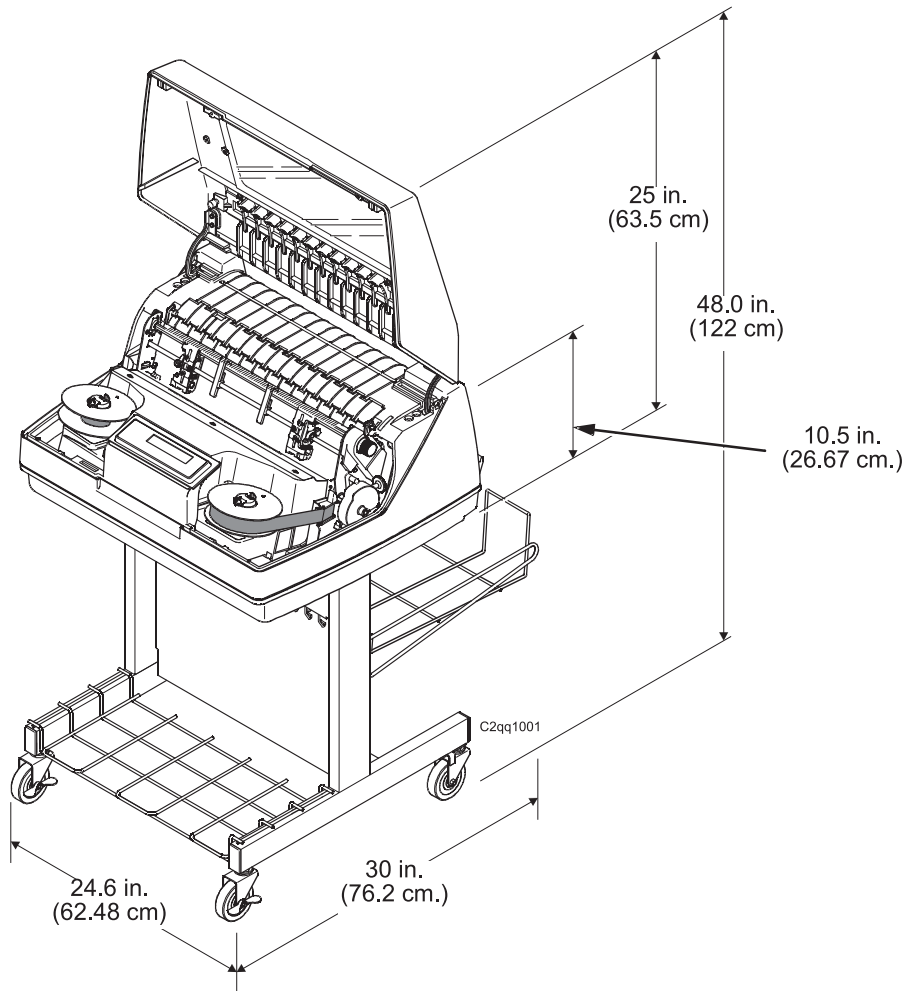

Figure 4. Exploded View of Pedestal Model Printer Dimensions

Printer Component Locations

Familiarize yourself with the names and locations of the printer components, shown in Figure 5 and Figure 6 before continuing with the rest of the installation procedures.

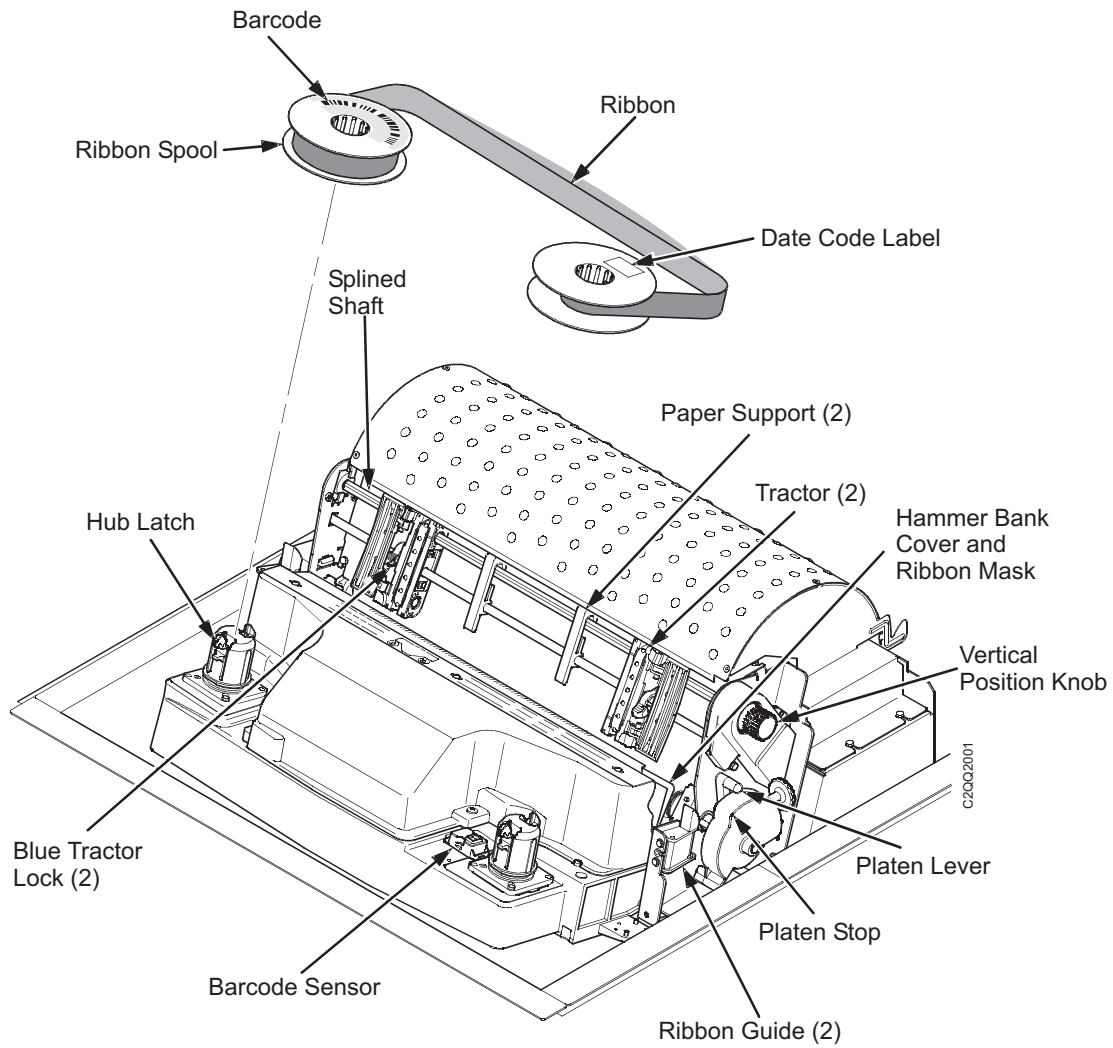

Figure 5. 6500 Printer Component Locations with the Ribbon Spools Exploded Above

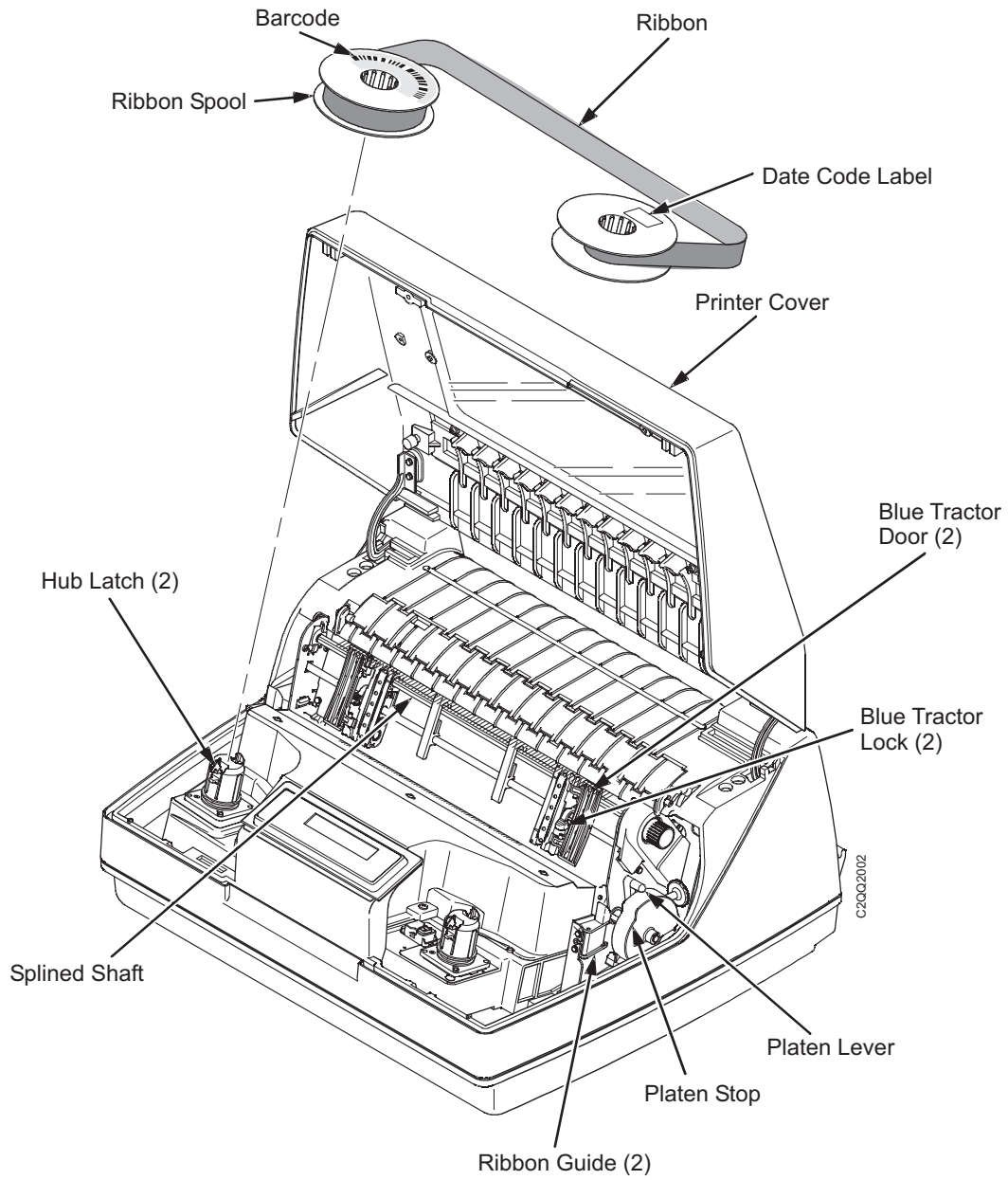

Figure 6. Pedestal Model Printer Component Locations with Open Access Cover and Ribbon Spools Exploded Above

Chapter 3. Configuring the Printer

IMPORTANT: Configuration directly affects printer operation. Do not try to change the configuration of your printer until you are thoroughly familiar with the procedures in this section.

Overview

To print data, the printer must respond correctly to signals and commands received from the host computer. Configuration is the process of matching the printer operating characteristics to those of the host computer and to specific tasks, such as printing labels, or printing on different sizes of paper. The characteristics that define the printer response to signals and commands received from the host computer are called configuration parameters.

You can configure the printer by pressing operator panel keys or by sending control codes from the host computer. This chapter explains how to use the operator panel to change individual parameters and save them as a custom configuration.

Your programmers reference manuals provide information about control codes.

The Configurations

A configuration consists of a group of parameters, such as line spacing and forms length. Your printer contains the following configurations:

- Four preloaded configurations that have been customized for printer setup.
- The factory default configuration. It can be loaded, but it cannot be altered.
- Four configurations that you can customize for unique print job requirements. The process of creating customized configurations is explained in “Changing Parameters” on page 30.

Active Versus Saved Configurations

When you change a parameter value, it is active as long as the printer is on or until it is changed again. This is true whether you use the operator panel or send a control code from the host. Parameter values defined by control codes override the active operator panel parameters when the printer is using any of the parallel or serial interfaces. For example, if you set the line spacing to 6 lpi with the operator panel, and application software later changes this to 8 lpi with a control code, the control code setting overrides the operator panel setting.

Using the operator panel, you can save the parameters as a customized configuration that is stored in nonvolatile random access memory (NVRAM). A saved configuration is not lost when you power off the printer.

Note: Saved configurations are also referred to as “custom sets”.

There are no control codes that allow you to save a parameter in NVRAM. However, you can save a configuration defined partially by control codes and store it in NVRAM using the operator panel. You can also save configuration values using PTR_SETUP (see “PTR Setup Option” on page 51.)

The Configuration Main Menu

Figure 7 on page 21 shows an overview of the printer configuration menus. The pages that follow describe how to enter program mode, print the current configuration, change configuration parameters, and save and load custom sets.

For specific configuration menu options and their descriptions, refer to Chapter 4, “The Configuration Menus,” on page 39.

Note: The menus that are displayed from the operator panel are determined by the installed features.

Each feature is shipped with a document that describes the feature in detail. For more information about these documents, see the “Related Documents” section on page xiv.

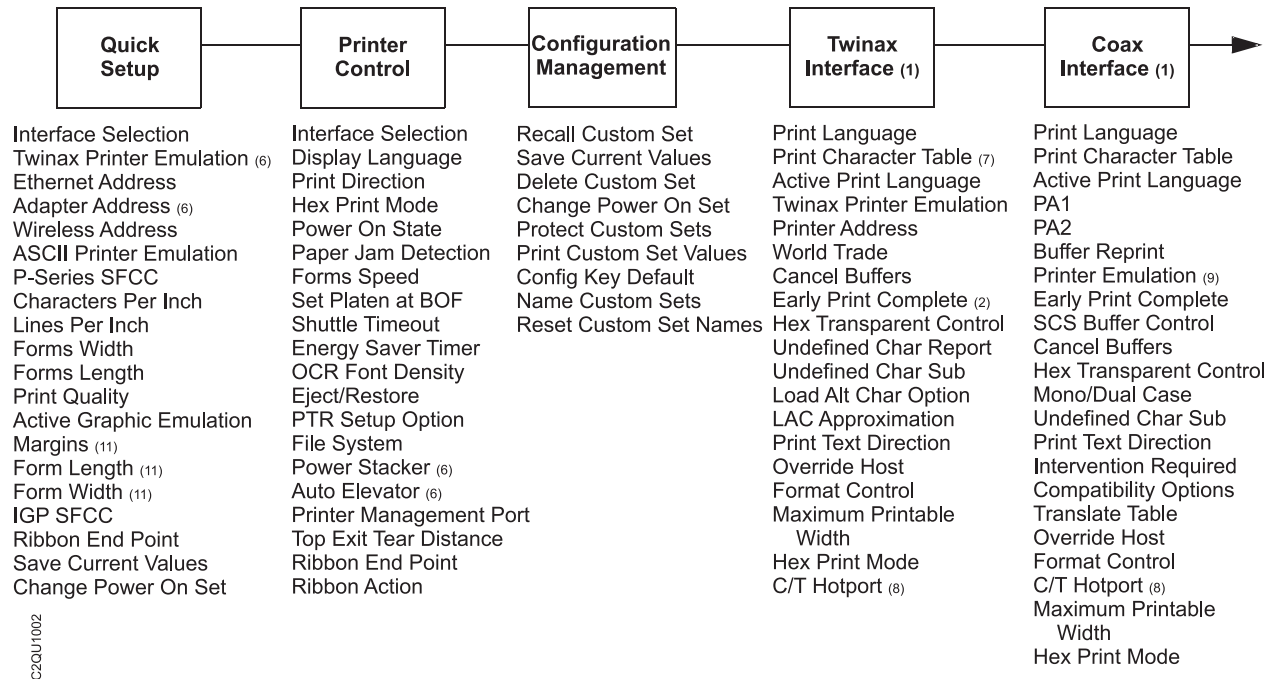
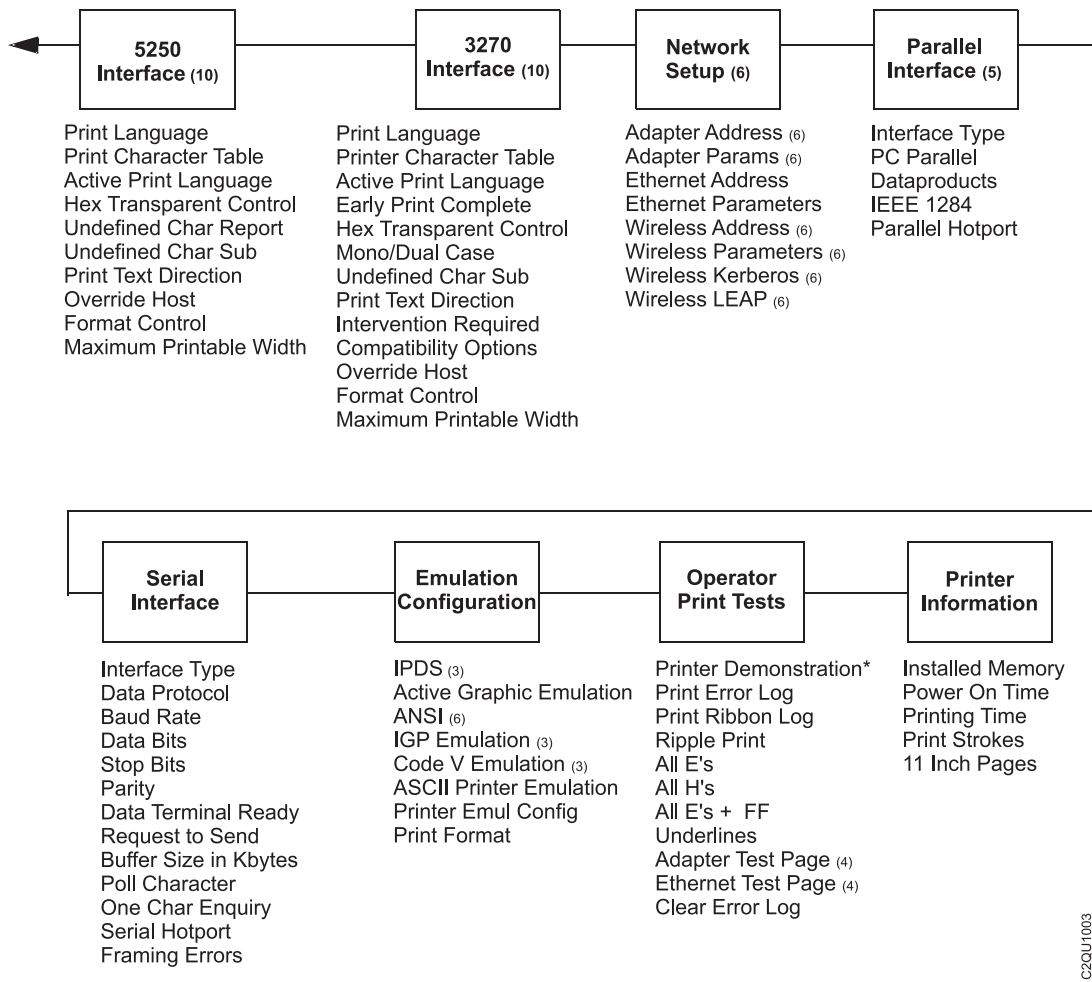

Figure 7. Configuration Main Menu

Notes:

1. The Twinax and Coax interface menus only appear in the menus if the Coax/Twinax feature is installed.
2. The Early Print Complete option appears in the Twinax menu only if the IPDS feature is installed.
3. IPDS, Code V Emulation, and IGP Emulation options appear in the menus only if these features are installed.
4. Ethernet information only appears when the Ethernet feature is installed.
5. Either the Ethernet Interface menu or the Parallel Interface menu will display. They cannot display at the same time.
6. If installed.
7. Not if 4234-12 is running IPDS code.
8. Only if Autoswitching is enabled.
9. Only if Coax Emulation is enabled.
10. The 5250 and 3270 Interface menu only appear in the menus if the TN5250/3270 feature is installed.
11. Only if ANSI is installed.



C20U1003

Figure 8. Configuration Main Menu (continued)

Using the Operator Panel

This section provides numerous examples of how to use the operator panel keys and indicator message display to configure the printer.

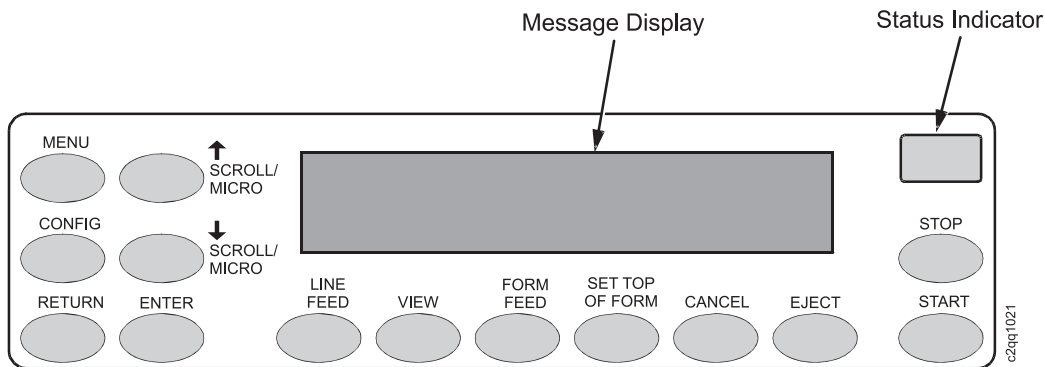

Figure 9. The Operator Panel

The operator panel is shown above. A physically common (but electrically different) operator control panel is used for both cabinet and pedestal models.

During the configuration process, you will use the **↑ SCROLL/MICRO**, **↓ SCROLL/MICRO**, **ENTER**, and **RETURN** keys on the operator panel to access configuration settings and diagnostic tests via the configuration menus. As you access menus and options, menu names and option values appear on the operator panel message display (sometimes referred to as LCD, or Liquid Crystal Display).

Message Display

An alphanumeric LCD display consists of a minimum of two rows of twenty-four characters each used to display printer status, fault messages, and menus to permit the operator to set various configurations. The display can be set to any one of the following languages: English, French, German, Italian, Spanish, Dutch, Brazilian-Portuguese, and Polish.

Status Indicator

A high visibility light for indicating general printer status. The light is on when the printer is **READY** (on-line to the host), off when the printer is **NOT READY** (off-line), or flashes if a fault condition exists.

Control Panel Overlay

An adhesive-backed overlay is provided that adheres to the face of the control panel. Overlays are provided in the following languages: English, French, German, Italian, Spanish, Dutch, Brazilian-Portuguese, and Polish. The overlay legends can be translated into additional languages as required.

Switch Functionality

Fourteen keys are provided for selecting and controlling printer features and options.

START

Use the **START** key to place the printer in the **READY** (on-line) state if it is off-line. Pressing **Start** in the Program mode exits the menus and places the printer in the **READY** state. After pressing **View** or **Eject** to move the print position to the tractor area, pressing the **START** key moves the paper back to its original print position, and places the printer in the **READY** state.

STOP Use the **STOP** key to place the printer in the *NOT READY* (off-line) state if it is on-line. When a fault condition exists, pressing **STOP** clears the fault and places the printer in the *NOT READY* state. After pressing **VIEW** or **EJECT** to move the print position to the tractor area, pressing **Stop** moves the paper back to its original print position and places the printer in the *NOT READY* state.

MENU

The **MENU** key operates only in the *NOT READY* state and is used to display the printers control menu. Press **MENU** repeatedly to view the menus without changing any settings. No configuration changes can be made when the Program state is locked. To change the configuration settings, press the **RETURN** and **ENTER** keys at the same time to unlock the Program state, then press **MENU**. The menu is then viewed using the **↑ SCROLL/MICRO**, **↓ SCROLL/MICRO**, and the **RETURN** and **ENTER** keys. When the Program state is unlocked, new values may be selected from the menus using the **ENTER** key.

CONFIG

(Printer configuration) The **CONFIG** key operates only in the *NOT READY* state. Pressing **CONFIG** prints the currently selected configuration. Pressing the **STOP** key stops printing and returns to *NOT READY*.

RETURN

The **RETURN** key operates only in the *NOT READY* state. In the Program state, it causes the display to move to a higher level in the menu structure.

Pressing the **RETURN** and **ENTER** keys at the same time unlocks the **ENTER** key when in the Program state.

↑ SCROLL/MICRO

Pressing the **↑ SCROLL/MICRO** key in the *READY* state has no effect and returns the message "INVALID KEY PRESS". In the *NOT READY* state, this key micro-steps the paper upward in 1/72 inch increments. Press and hold the key to move paper at 10 increments per second. In the **MENU** state, pressing **↑ SCROLL/MICRO** navigates the menu and does not move the paper.

↓ SCROLL/MICRO

Pressing the **↓ SCROLL/MICRO** key in the *READY* state has no effect and returns the message "INVALID KEY PRESS". In the *NOT READY* state, this key micro-steps the paper downward in 1/72 inch increments. Press and hold the key to move paper at 10 increments per second. When in the **MENU** state, pressing this key navigates the menu and does not move the paper.

ENTER

The **ENTER** key operates only in the *NOT READY* state.

- In the Program state it moves the display to a lower level in the menu structure.
- In the unlocked Program state it selects a configuration option value.
- In the Program state it starts and stops a Print Test selected from the Operator Print Tests menu.

- In the *NOT READY* state pressing **STOP** and **ENTER** performs a soft reset of the printer which resets the printer to the Power On configuration.

Pressing the **ENTER** and **STOP** keys at the same time while the printer is in the *NOT READY* state causes a soft reset.

Pressing the **RETURN** and **ENTER** keys at the same time unlocks the **ENTER** key when in the Program state.

LINE FEED

Pressing the **LINE FEED** key when in the *NOT READY* state, prints any data in the buffer and then moves the paper. Data not in the buffer is not affected. The initial paper motion is one line at the currently defined line spacing. **LINE FEED** repeats if the key is continually held down.

VIEW Pressing the **VIEW** key in the *NOT READY* state moves the paper from the current print position up to the tractor area for viewing. If there is any data left in the print buffer, it is printed and then the paper moves up for viewing. Pressing **VIEW** a second time or pressing **START** or **STOP** returns the paper to its original print position.

FORM FEED

Pressing and releasing the **FORM FEED** key in the *NOT READY* state moves the paper to the top-of-form on the next page. If there is any data in the print buffer, it prints first and then the paper moves to the next top-of-form. Data not in the print buffer is not affected. Press the **FORM FEED** key in the Fault state to silence the alarm and cause the paper to move. The top-of-form setting is lost.

SET TOP OF FORM

Pressing the **SET TOP OF FORM** key in the *NOT READY* state, unless there is data in the buffer, moves the paper downward relative from the TOF alignment index to the print station and sets this position to be the top of form. Positions the TOF correctly, independent of the form length. If there is data in the buffers, this data is printed and then the printer slews to the place on the page where the printing left off.

CANCEL

Pressing the **CANCEL** key clears all of the data in the print buffer. This key can be disabled in the menus. The **CANCEL** key is not active during **VIEW** and **EJECT** operations. The **CANCEL** key does the following:

1. Stops printer tests in progress.
2. Cancels a print job. This operation depends on the printer interface.

Coax Interface (non-SCS mode)

The **CANCEL** key is not effective and the "009 INVALID KEY" error message displays.

Note: With a Coax Interface, press the **CANCEL** key a second time to stop the previous cancel.

Coax Interface (SCS mode)

Effective in the *NOT READY* state, but the action

occurs only in the *READY* state. When pressed, the “059 CANCEL PRINT ACTIVE” message is displayed.

Twinax Interface

Effective in the *READY* and *NOT READY* states. When pressed, the “059 CANCEL PRINT ACTIVE” message is displayed.

IPDS Interface

Ethernet (IPDS mode): Effective in the *NOT READY* state. The two forms of cancel are:

- a. **Full Cancel:** A **CANCEL** command is sent to the host requesting that the print job be cancelled and the next job in the queue be submitted for printing. This is done by pressing the **CANCEL** key twice. When pressed, the “059 CANCEL PRINT ACTIVE” message is displayed.
- b. **Clear Buffers:** A **Clear Buffers** command is sent to the host informing the host that the printer has cleared its buffers. At this point, the job can be restarted from any page based on the instruction from the host. This is done by pressing the **CANCEL** key once, then pressing the **STOP** key. When pressed, the “069 DATA CLEARED” message is displayed.

Serial/Parallel/Ethernet Interface

We recommend that you stop the print job from the host system before you press **CANCEL**. Effective in the *NOT READY* state. When pressed, the “069 DATA CLEARED” message is displayed.

EJECT The **EJECT** key has two modes of operation. Standard mode is the only mode available on the cabinet models. For pedestal models (without zero tear option), the Standard mode can be selected from the menu and should be selected when using the rear paper exit. In Standard mode, the **EJECT** key moves the paper forward to facilitate tearing off the paper at the perforation then restores the original paper position. Once the paper is torn at the perforation, pressing either the **EJECT**, **START**, or **Stop** keys retracts the paper to its previous position, as described below:

EJECT Moves the paper to its previous position. The printer returns to the mode it was in before **EJECT** was used.

START

Moves the paper to its previous position and places the printer in the *READY* state.

STOP Moves the paper to its previous position and places the printer in the *NOT READY* state.

If the paper is to be torn off, the **FORM FEED** key must be pressed before pressing the **EJECT**, **START**, or **STOP** keys. This feeds an additional page first and prevents the paper from unloading when it is restored to its original position after the form is torn off.

For pedestal models (without zero tear option), in the Top Exit Tear mode (selectable at the operator panel), this key moves the paper to the top of the next form. In the *NOT READY* state, pressing the

| **EJECT** key moves the paper forward to the tear-off position. In the
| *NOT READY* state, pressing the **EJECT** key moves the paper
| forward to the tear-off position. Pressing one of the following keys
| has the function described below:

| **EJECT** Moves the paper to its next available position. The printer
| returns to the mode it was in before **EJECT** was pressed.

| **START**
| Moves the paper to its next available position and places
| the printer in the *READY* state.

| **STOP** Moves the paper to its previous position and places the
| printer in the *NOT READY* state.

Program Mode

The printer is in Program mode whenever the configuration menus and option values are displayed on the operator panel message display. Program mode is either locked or unlocked. In order to select new configuration values, you must unlock Program mode. In order to prevent accidental changing of the configuration settings, you may lock Program mode.

Unlocking The Program Mode

To use the operator panel to change the configuration settings, Program mode must be unlocked. When Program mode is unlocked, pressing the **Enter** key selects configuration values as the active values, that is, places them into printer DRAM. An asterisk (*) after a displayed setting shows it is entered into memory.

Press the **Return + Enter** keys at the same time to unlock Program mode. The following message will appear briefly:

OPERATOR MENU UNLOCKED

Locking The Program Mode

When Program mode is locked, you cannot use the operator panel to change the configuration settings. However, you can still select the configuration menus and view the current configuration settings.





Press the **Return + Enter** keys at the same time to lock Program mode. The following message will appear briefly:

OPERATOR MENU LOCKED

Entering Program Mode

To place the printer in Program mode, press the **MENU** key.

Printing the Current Configuration

Step	Key	LCD Result	Notes
1. Make sure the printer is on			
2. Press	STOP 	NOT READY	The printer must be in NOT READY mode to print the configuration.
3.	CONFIG 	PRESS START TO PRINT PRESS STOP TO EXIT	You are prompted to press the START key before the configuration prints.
4.	START 	NOT READY	Indicates that the configuration has printed. Date and store the printout in a safe place. You may also want to label the printout (for example, "Configuration for 2-up Labels").
5.	START 	READY	The printer is READY for normal operation.

The second method for printing the current configuration, as well as several other configurations, is to use the Print Custom Set Values menu option, shown on the following page.

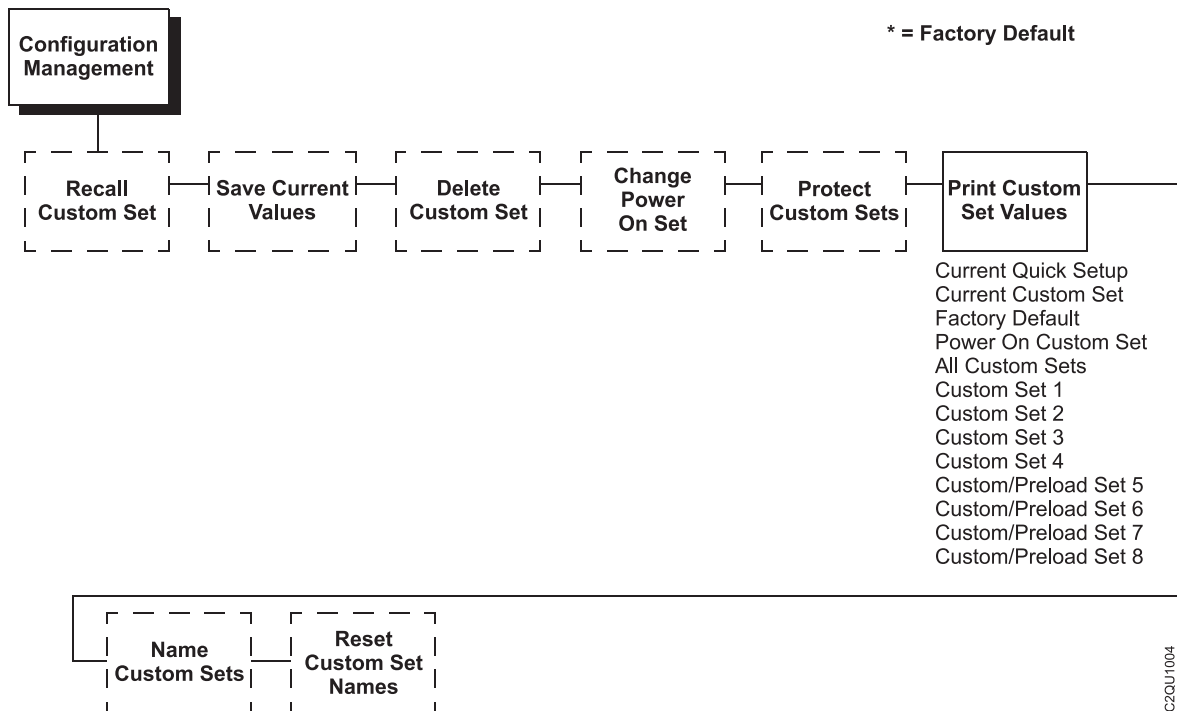

Figure 10. Configuration Management Menu - Print Custom Set Values

The Print Custom Set Values selection on the Configuration Management menu allows you to print any or all of the configurations shown above. The default setting, “Current Custom Set”, will print the same information as pressing the Printer Configuration key. The Current Custom Set is the Power On configuration until you begin modifying the printer configuration.

Custom sets 1 through 4 do not exist until you save configuration parameters to them. You must define and save a custom set before you can print it.

Custom/Preload Sets 5 through 8 contain configuration sets that assist with the installation and configuration of this printer.

The other options will only be useful once you have modified and saved the printer configuration parameter settings.

The Power On Custom Set is defined by the “Change Power On Set” option.

Custom Sets 1 through 8 are defined by the “Save Current Values” option.

These options are described in detail under the Configuration Management Menu description starting on page 54.

Changing Parameters

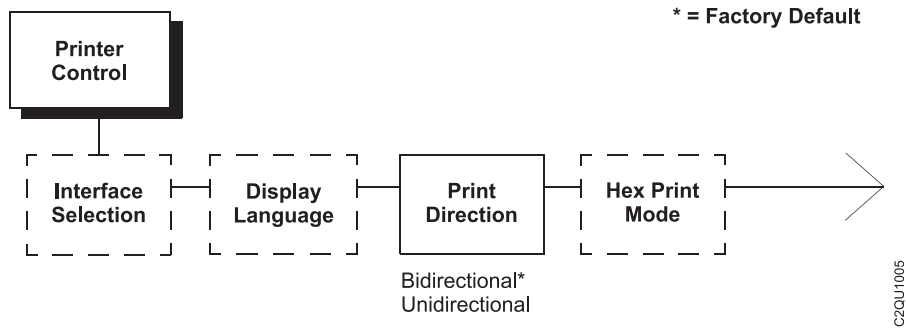









Figure 11. Printer Control Menu - Print Direction

The following procedure shows you how to change a configuration setting. Changing the Print Direction from the factory default setting BIDIRECTIONAL to the setting UNIDIRECTIONAL is provided as an example. Print Direction is one of the Printer Control menu options. The procedure is similar for other configuration changes. Use these basic guidelines to navigate the configuration menus and change other parameters.

Note: Press **START** at any time to exit the configuration menu.

Step	Key	LCD Results	Notes
1.		Determine which parameters you want to change and what the new values will be. In this example, the value for the PRINT DIRECTION parameter will be changed from "BIDIRECTIONAL" to "UNIDIRECTIONAL".	
2.	Press ○	NOT READY	Places the printer in NOT READY mode before entering the operator menus.
3.	○ + ○ RETURN ENTER	OPERATOR MENU UNLOCKED	Unlocks the Operator Menu, which allows you to make configuration changes.
4.	○ MENU	OPERATOR MENU PRINTER CONTROL	Displays the first Configuration Main Menu option, PRINTER CONTROL.
5.	○ ENTER	PRINTER CONTROL INTERFACE SELECTION	Moves into the PRINTER CONTROL menu.
6.	○ ↑ SCROLL/ MICRO UNTIL	PRINTER CONTROL PRINT DIRECTION	Moves to the PRINT DIRECTION parameter.
7.	○ ENTER	PRINT DIRECTION BIDIRECTIONAL*	Move into the PRINT DIRECTION menu. The asterisk (*) shows that this is the active value.

Step	Key	LCD Results	Notes
8.	 	PRINT DIRECTION UNIDIRECTIONAL	Moves to the next available option, the UNIDIRECTIONAL option.
9.	ENTER 	PRINT DIRECTION UNIDIRECTIONAL*	Selects the displayed value. An asterisk (*) appears indicating that this choice is now the active value.
10.	Continue this pattern to make all of the changes, using the information in this chapter.		
11.	To save changes so that they will remain when the printer is reset or powered back on, see "Saving Your Configuration in a Custom Set" on page 32. If you want to use these values without saving, continue to the next step.		
12.	STOP 	NOT READY	Returns the printer to the NOT READY mode.
13.	 + 	OPERATOR MENU LOCKED	Locks Program mode and the Operator Menu.
14.	STOP 	READY	Places the printer in READY mode, prepared for normal operation.

Saving Your Configuration in a Custom Set

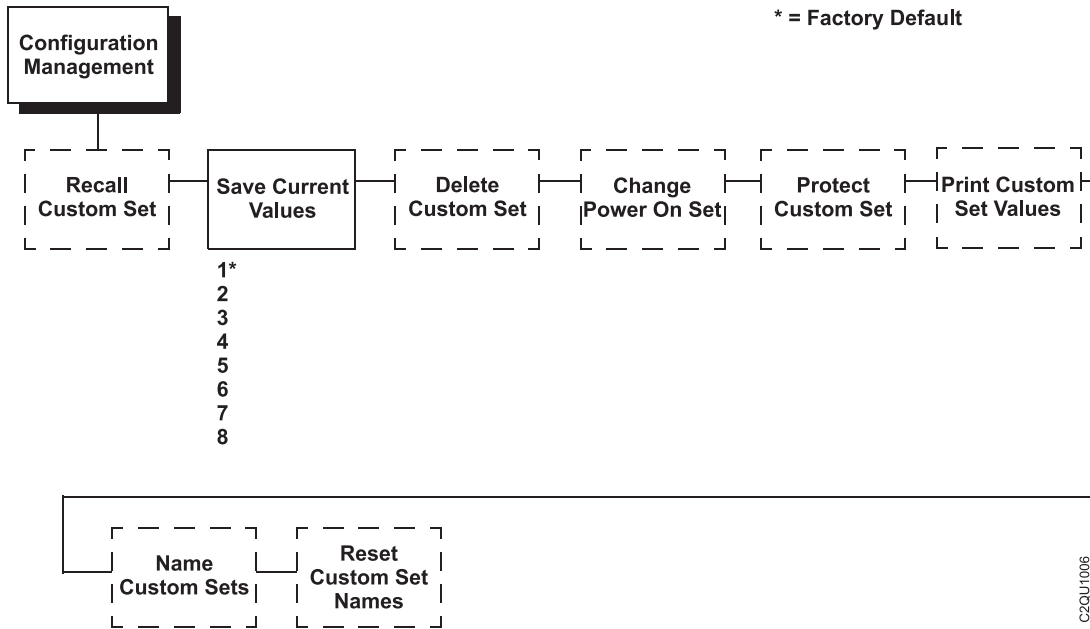

Figure 12. Configuration Management Menu - Save Current Values

Once you have changed all of the necessary parameters, it is recommended you save them as a configuration that can be stored and loaded later for future use. You can save your configurations to meet different print job requirements.











The saved configurations (called custom sets) are stored in NVRAM—they will not be lost if you power off the printer.



Later, you can load one of the configurations for a specific print job. This eliminates the need to change settings, such as CPI and LPI, for each new job. See “Loading Custom Sets or Factory Default Values” on page 35 for details on loading configurations.

You may want to print records of your configurations (see “Printing the Current Configuration” on page 28) and store them in a safe place, such as inside the printer cabinet.

If you do not save your configuration before you power off the printer, all of the new parameter values that have not been saved to NVRAM will be erased. When you power the printer on again, the power-on configuration will load. If no configuration has been designated as the power-on configuration, the factory configuration will load.

Note: To avoid overwriting an existing custom set, the Protect Custom Sets parameter must be set to ENABLE. See “Protect Custom Sets” on page 56 for details.

Step	Key	LCD Results	Notes
1. Press	STOP 	NOT READY	Places the printer in NOT READY mode.
2.	RETURN + ENTER  + 	OPERATOR MENU UNLOCKED	Unlocks the Operator Menu, which allows you to make configuration changes.
3.	MENU 	OPERATOR MENU PRINTER CONTROL	Displays the first Configuration Main Menu option, PRINTER CONTROL.
4.	 ↑ UNTIL	OPERATOR MENU CONFIGURATION MANAGEMENT	Moves to the Configuration Management menu option.
5.	ENTER 	CONFIGURATION MANAGEMENT RECALL CUSTOM SET	Selects the CONFIGURATION MANAGEMENT menu. The RECALL CUSTOM SET option appears.
6.	 ↑ UNTIL	CONFIGURATION MANAGEMENT SAVE CURRENT VALUES	Moves to the SAVE CURRENT VALUES option.
7.	ENTER 	SAVE CURRENT VALUES 1*	Selects the SAVE CURRENT VALUES menu.
8.	 ↑ UNTIL	SAVE CURRENT VALUES 2	Scrolls through the list of custom sets 1 - 8.
9.	ENTER 	SAVING CONFIGURATION	Selects the SAVE CURRENT VALUES option. The message “SAVING CONFIGURATION” appears briefly.
10.	STOP 	NOT READY	Returns the printer to the NOT READY mode.

Step	Key	LCD Results	Notes
11.	 	OPERATOR MENU LOCKED	Locks Program mode and the Operator Menu.
12.		READY	Places the printer in READY mode, prepared for normal operation.
13. It is recommended you print your current configuration, as described on page 28.			

Loading Custom Sets or Factory Default Values

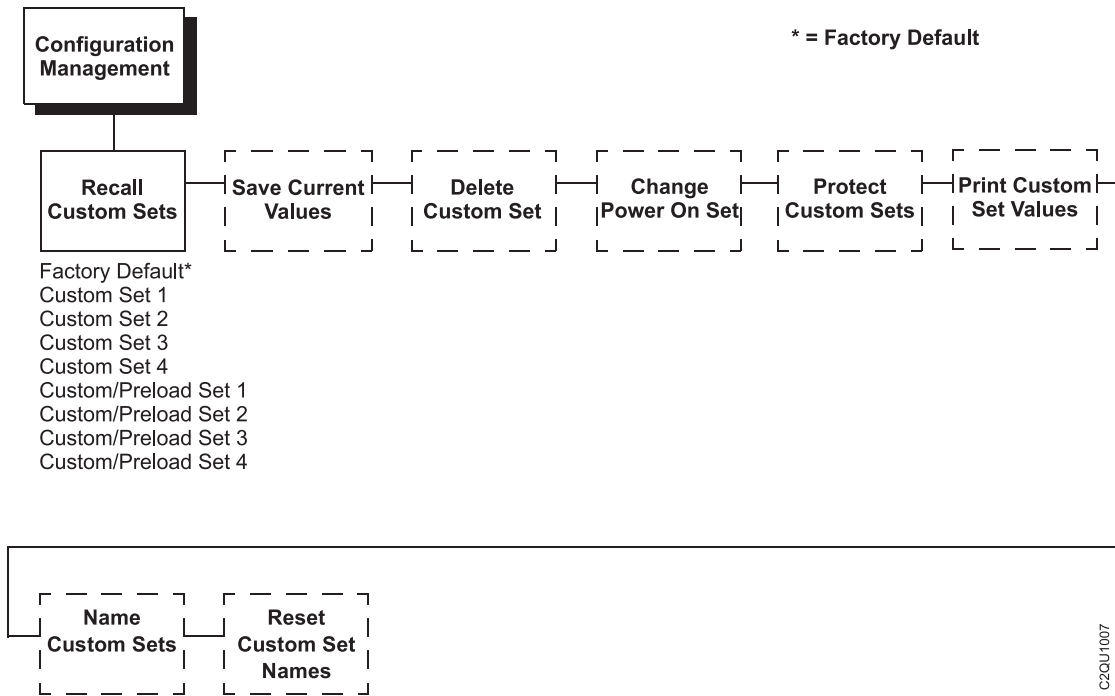







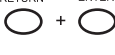



Figure 13. Configuration Management Menu - Recall Custom Sets

You can load any of the custom set configurations or the factory default configuration. The loaded configuration remains active as long as the printer is on. The following procedure shows how to load factory defaults to the printer.

If you power off the printer, the power-on configuration will load the next time the printer is powered on. Selecting the power-on configuration is explained on page 37.

Step	Key	LCD Results	Notes
1. Press	STOP 	NOT READY	Places the printer in NOT READY mode.
2.	RETURN + ENTER 	OPERATOR MENU UNLOCKED	Unlocks the Operator Menu, which allows you to make configuration changes.
3.	MENU 	OPERATOR MENU PRINTER CONTROL	Displays the first Configuration Main Menu option, PRINTER CONTROL.
4.	↑ SCROLL/ MICRO UNTIL 	OPERATOR MENU CONFIGURATION MANAGEMENT	Moves to the Configuration Management menu option.
5.	ENTER 	CONFIGURATION MANAGEMENT RECALL CUSTOM SET	Selects the CONFIGURATION MANAGEMENT menu. The RECALL CUSTOM SET option appears.
6.	ENTER 	RECALL CUSTOM SET FACTORY DEFAULT	Moves forward to the FACTORY DEFAULT parameter for the RECALL CUSTOM SET option.
7.	ENTER 	LOADING SAVED CONFIGURATION	Loads the set of Factory Default values. The message "LOADING SAVED CONFIGURATION" appears briefly.
8.	STOP 	NOT READY	Returns the printer to the NOT READY mode.
9.	RETURN + ENTER 	OPERATOR MENU LOCKED	Locks Program mode and the Operator Menu.
10.	STOP 	READY	Places the printer in READY mode, prepared for normal operation.

Changing the Power On Configuration

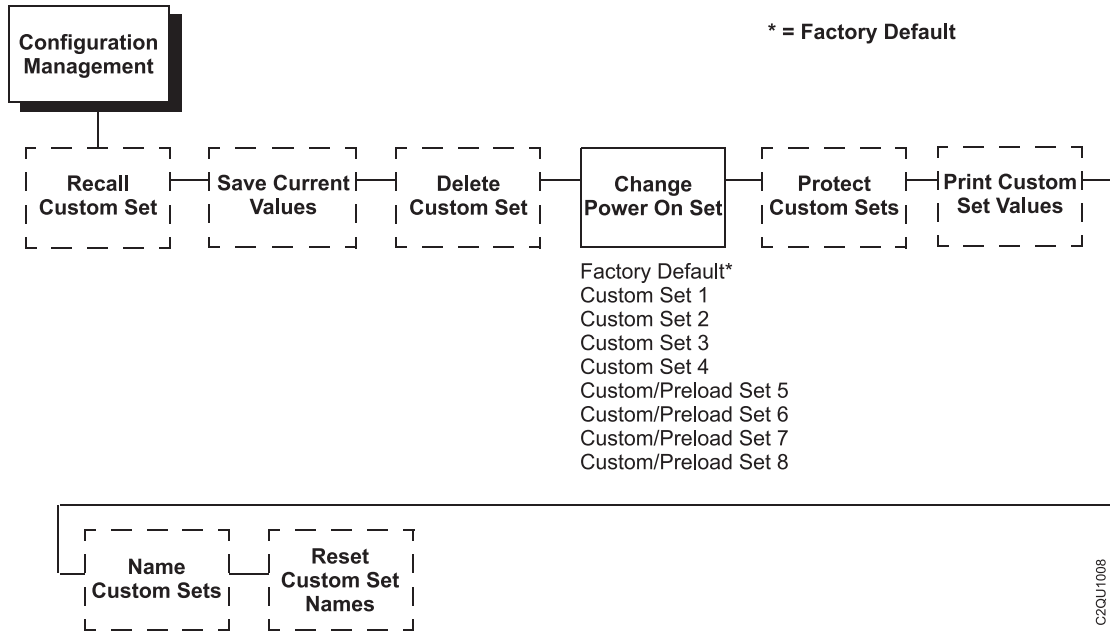

Figure 14. Configuration Management Menu - Change Power On Set















When you power on the printer for the first time, it loads the factory default configuration. If you power the printer off and then back on, the printer will load the designated power-on configuration (which is set to Factory Default by default). It will not load the last saved configuration.

The Change Power On Set option allows you to select a custom set of configuration values as the power-on configuration. The example on the following page shows how to select Custom Set 1 as the power-on configuration.

Note: Be sure you define and save a custom set before attempting to use it as the Power On Custom Set. Otherwise, the current Power On Custom Set remains selected and the following operator panel message is displayed:

```
042 CUSTOM SET DOES NOT EXIST
SAVE FIRST
```

For example, if you attempt to change the Power On Custom Set from Custom Set 1 to Custom Set 4, and if Custom Set 4 does not exist, Custom Set 1 remains the Power On Custom Set.

Step	Key	LCD Results	Notes®
1. Press	STOP 	NOT READY	Places the printer in NOT READY mode.
2.	RETURN + ENTER  + 	OPERATOR MENU UNLOCKED	Unlocks the Operator Menu, which allows you to make configuration changes.
3.	MENU 	OPERATOR MENU PRINTER CONTROL	Displays the first Configuration Main Menu option, PRINTER CONTROL.
4.	↑  SCROLL/MICRO UNTIL	OPERATOR MENU CONFIGURATION MANAGEMENT	Moves to the Configuration Management menu option.
5.	ENTER 	CONFIGURATION MANAGEMENT RECALL CUSTOM SET	Selects the CONFIGURATION MANAGEMENT menu. The RECALL CUSTOM SET option appears.
6.	↑  SCROLL/MICRO OR ↓  SCROLL/MICRO	CONFIGURATION MANAGEMENT CHANGE POWER ON SET	Moves to the CHANGE POWER™ SET ON parameter.
7.	ENTER 	CHANGE POWER ON SET FACTORY DEFAULT	Displays the first POWER ON SET option, FACTORY DEFAULT.
8.	↑  SCROLL/MICRO	CHANGE POWER ON SET CUSTOM SET 1	Displays CUSTOM SET 1 as the POWER ON SET option value.
9.	ENTER 	CHANGE POWER ON SET CUSTOM SET 1*	An asterisk (*) appears after the change is complete.
10.	STOP 	NOT READY	Returns the printer to the NOT READY mode.
11.	RETURN + ENTER  + 	OPERATOR MENU LOCKED	Locks Program mode and the Operator Menu.
12.	STOP 	READY	Places the printer in READY mode, prepared for normal operation.

Chapter 4. The Configuration Menus

Configuration Overview

This section describes the configuration menus. The Configuration Main Menu options and all of the submenu options are illustrated in menu diagrams and described in detail. For procedures showing how to enter Program mode, save, recall, and print configurations, refer to Chapter 3, “Configuring the Printer,” on page 19.

Figure 15 on page 40 shows an overview of the configuration menus.

The menus that are displayed from the operator panel are determined by the installed features. For example, if you ordered the IPDS feature, then the IPDS menu would appear on the operator panel. If the IPDS feature is not installed, then the IPDS menu will not appear on the operator panel.

Each feature is shipped with a document that describes the feature in detail. For more information about these documents, see “Related Documents” on page xiv.

The configuration menu diagram on page 40 shows the structure of the configuration menus and the parameter options available in each menu. The diagrams list the menus and options in the order they appear when you use the operator panel to configure the printer. Factory default configuration values are indicated by an asterisk (*).

Pressing the operator panel keys (**ENTER**, **RETURN**, **↑ SCROLL/MICRO**, and **↓ SCROLL/MICRO**) allows you to move through the menus and select various choices for the options, as follows:

- The **ENTER** key allows you to move down to a lower level in the menu structure, and to select an option value as the active value.
- The **RETURN** key moves you back up the menu structure.
- The **↑ SCROLL/MICRO** key moves forward through the options at a particular menu level.
- The **↓ SCROLL/MICRO** key moves backward through the options at a particular menu level.

These keys are summarized in a legend box at the lower right corner of each configuration menu diagram.

Main Menu

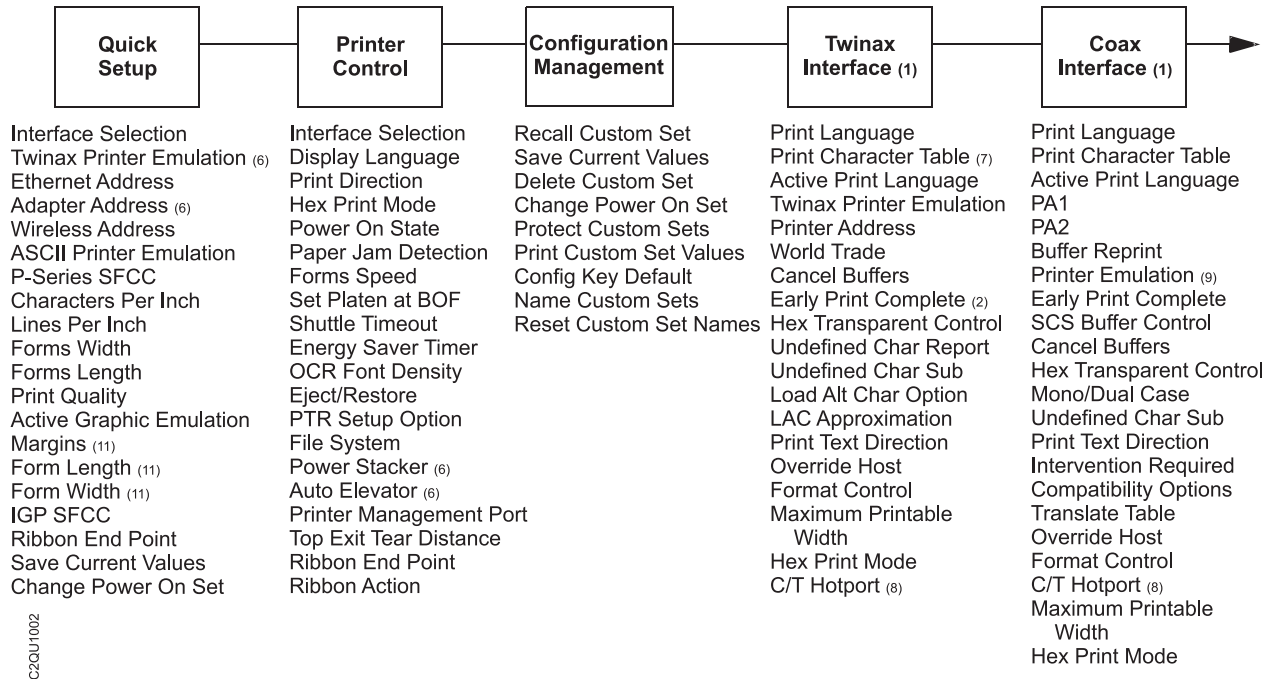

Figure 15. 6500 Series Main Menu Configuration

Notes:

1. The Twinax and Coax interface menus only appear in the menus if the Coax/Twinax feature is installed.
2. The Early Print Complete option appears in the Twinax menu only if the IPDS feature is installed.
3. IPDS, Code V Emulation, and IGP Emulation options appear in the menus only if these features are installed. Menus are shown in Appendix D, "Attaching Host Systems to a Coax/Twinax Printer," on page 273.
4. Ethernet information only appears when the Ethernet feature is installed.
5. Either the Ethernet Interface menu or the Parallel Interface menu will display. They cannot display at the same time.
6. If installed.
7. Not if 4234-12 is running IPDS code.
8. Only if Autoswitching is enabled.
9. Only if Coax Emulation is enabled.
10. The 5250 and 3270 Interface menu only appear in the menus if the TN5250/3270 feature is installed.
11. Only if ANSI is selected.

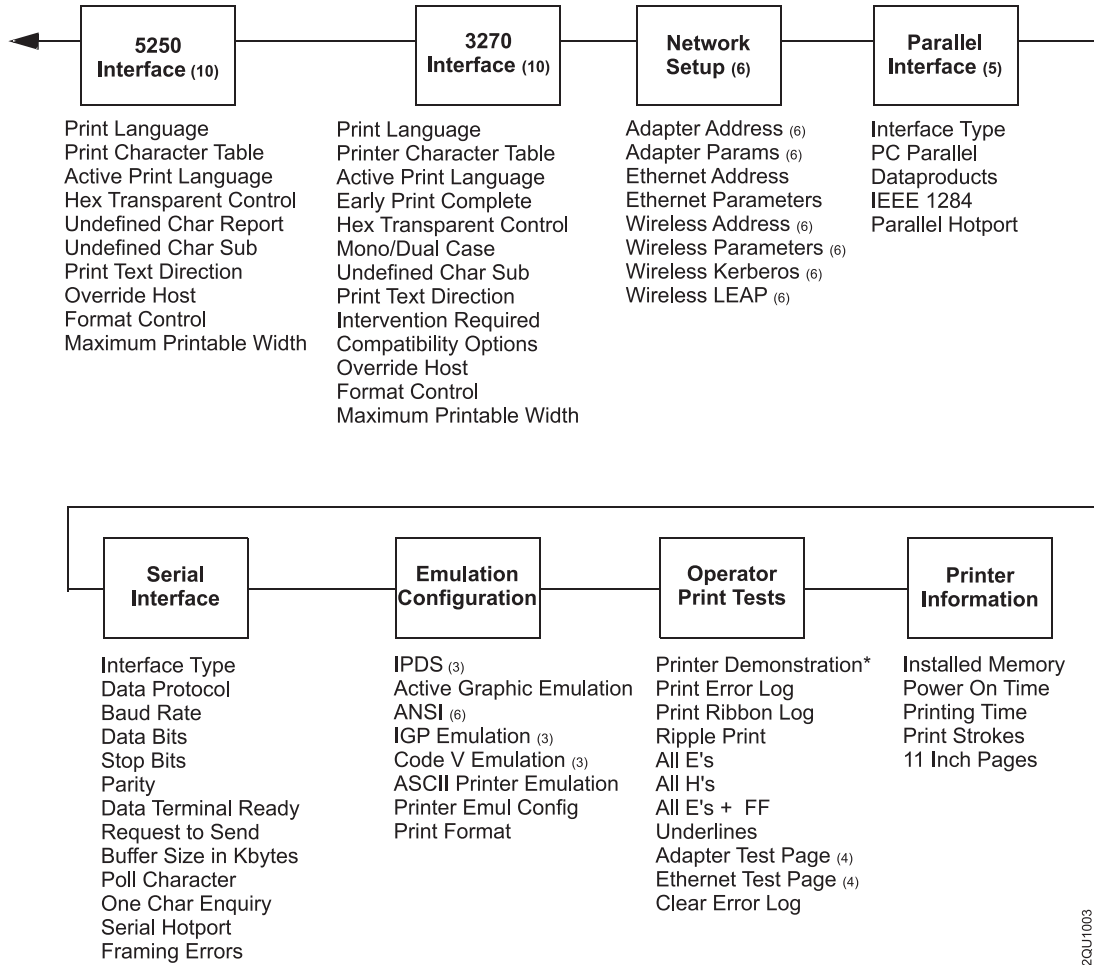

Figure 16. 6500 Series Main Menu Configuration (continued)

C20U1003

Quick Setup Menu

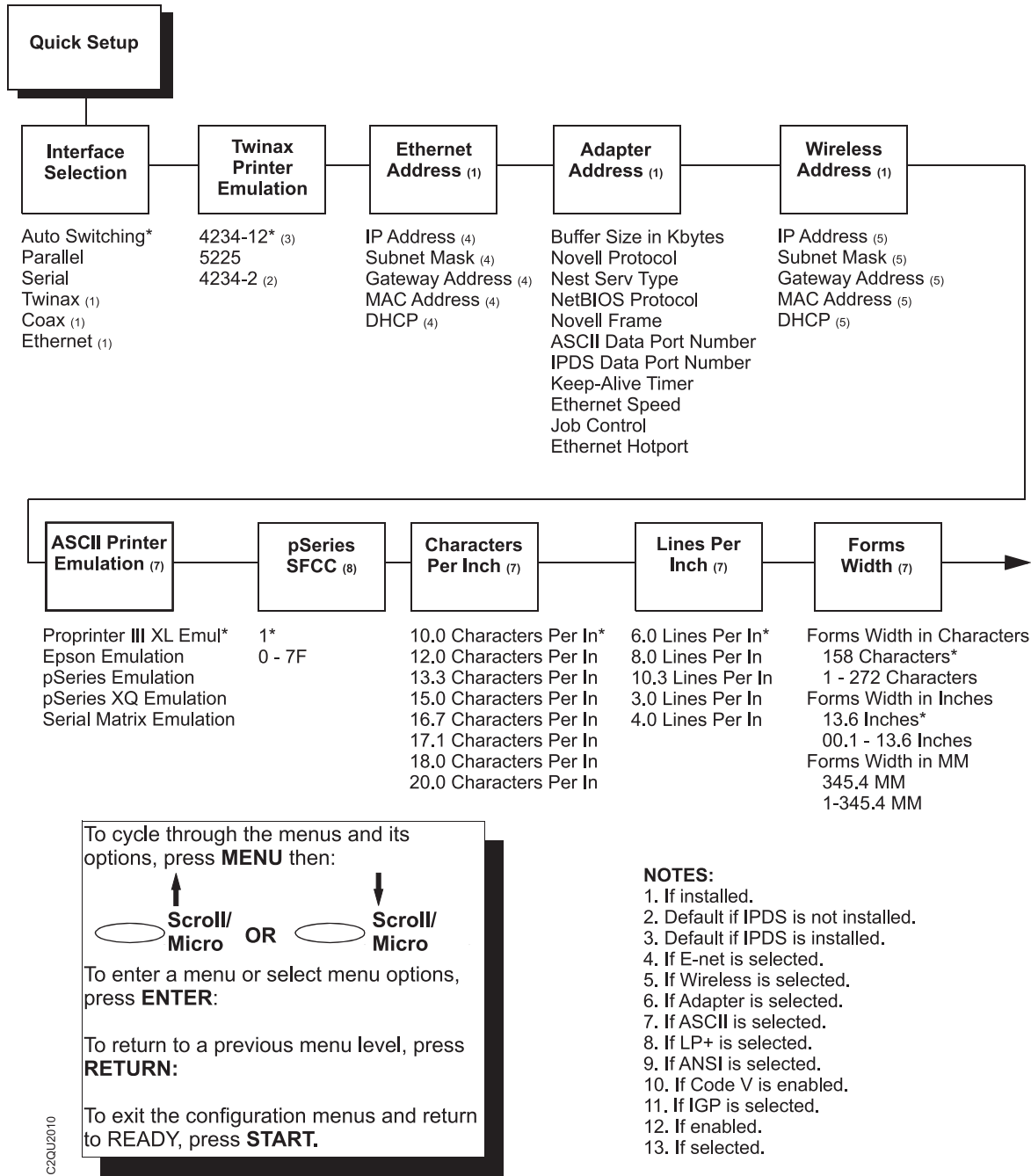
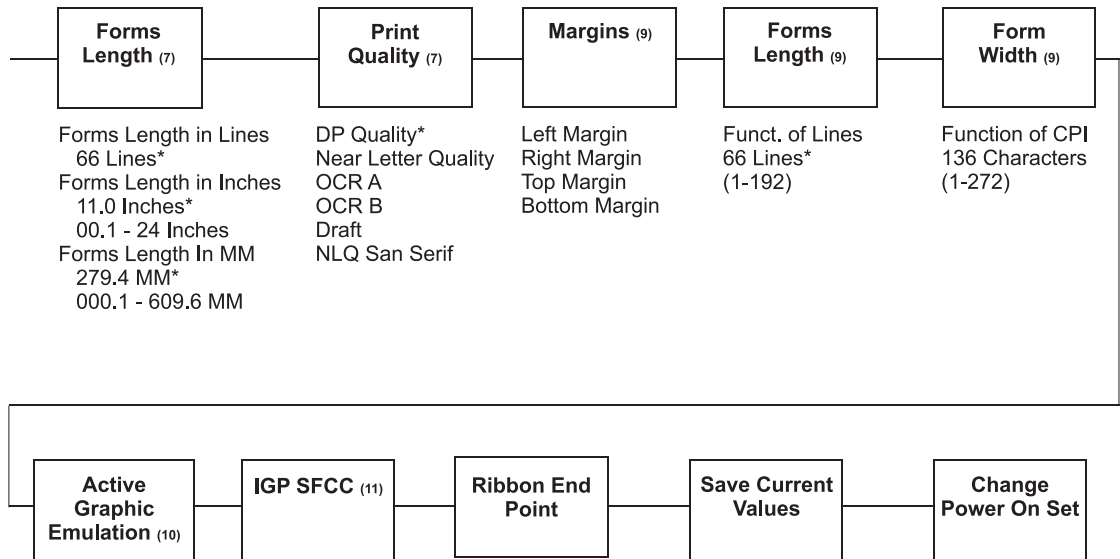

Figure 17. Quick Setup Menu

Quick Setup
(Continued)



Forms Length in Lines
66 Lines*
Forms Length in Inches
11.0 Inches*
00.1 - 24 Inches
Forms Length In MM
279.4 MM*
000.1 - 609.6 MM

DP Quality*
Near Letter Quality
OCR A
OCR B
Draft
NLQ San Serif

Left Margin
Right Margin
Top Margin
Bottom Margin

Funct. of Lines
66 Lines*
(1-192)

Function of CPI
136 Characters
(1-272)

IGP*
Code V (12)

7E* (13)

Darker +6
Darker +5
Darker +4
Darker +3
Darker +2
Darker +1
Normal
Lighter -1
Lighter -2
Lighter -3
Lighter -4
Lighter -5
Lighter -6
Lighter -7
Lighter -8
Lighter -9
Lighter -10

Custom Set 1*
Custom Set 2
Custom Set 3
Custom Set 4
Custom/Preload Set 5
Custom/Preload Set 6
Custom/Preload Set 7
Custom/Preload Set 8

Factory Default
Custom Set 1*
Custom Set 2
Custom Set 3
Custom Set 4
Custom/Preload Set 5
Custom/Preload Set 6
Custom/Preload Set 7
Custom/Preload Set 8

NOTES:

1. If installed.
2. Default if IPDS is not installed.
3. Default if IPDS is installed.
4. If E-net is selected.
5. If Wireless is selected.
6. If Adapter is selected.
7. If ASCII is selected.
8. If LP+ is selected.
9. If ANSI is selected.
10. If Code V is enabled.
11. If IGP is selected.
12. If enabled.
13. If selected.

To cycle through the menus and its options, press **MENU** then:

To enter a menu or select menu options, press **ENTER**:

To return to a previous menu level, press **RETURN**:

To exit the configuration menus and return to READY, press **START**.

C20U2011

Figure 18. Quick Setup Menu (continued)

The purpose of the Quick Setup menu is to have the items that are most frequently changed or entered during the installation of the printer in one location. This is not a “quick access” menu, in that the items found here will generally only be needed during the initial setup rather than on an ongoing basis. Only those items where input is needed to enable printing from a host system and establish rudimentary printing parameters are included. All other menu selections not part of this section can be left in their default state to achieve successful printing.

Most items displayed for selection in the Quick Setup menu dynamically change depending on which Host Interface options are installed and selected or which active emulation is selected. Only items that are routinely selected, modified or confirmed during initial setup will be displayed (not full menus). In most cases, the default settings provided throughout should be sufficient to initiate successful printing and only need to be confirmed.

Changes made in the Quick Setup menu will have global impact. For example, host interface settings made will carry forward and reflect in the Host Interface menu as well. Similarly, changes made to any other parameter will be universally applied (changing the default values) in all emulations or locations where these settings are applicable.

An Active Emulation menu has been added. Depending on the emulations installed or selected, a series of additional menus will appear dynamically, depending on which emulation was chosen. The choice of emulations offered depends on what emulations are included in the printer’s software and have been enabled by the Security Key.

As the active emulation is selected from either the Quick Setup Menu or from the original Active Emulation menu location, the corresponding bottom menus for the remaining emulations will be hidden. Only the menu tree for the selected active emulation will be displayed.

If IPDS is installed, it will become the default emulation. There is no IPDS specific menu items placed in the Quick Setup menu selections. However, the user can define the ASCII settings. If IPDS is not installed, then ASCII Printer will be made the default selection. If ANSI is installed, then the menu will provide the user with the choice between ANSI or ASCII Printer. If either TN3270 or TN5250 are installed, this emulation becomes the default, with all default values accepted.

Printer Control Menu

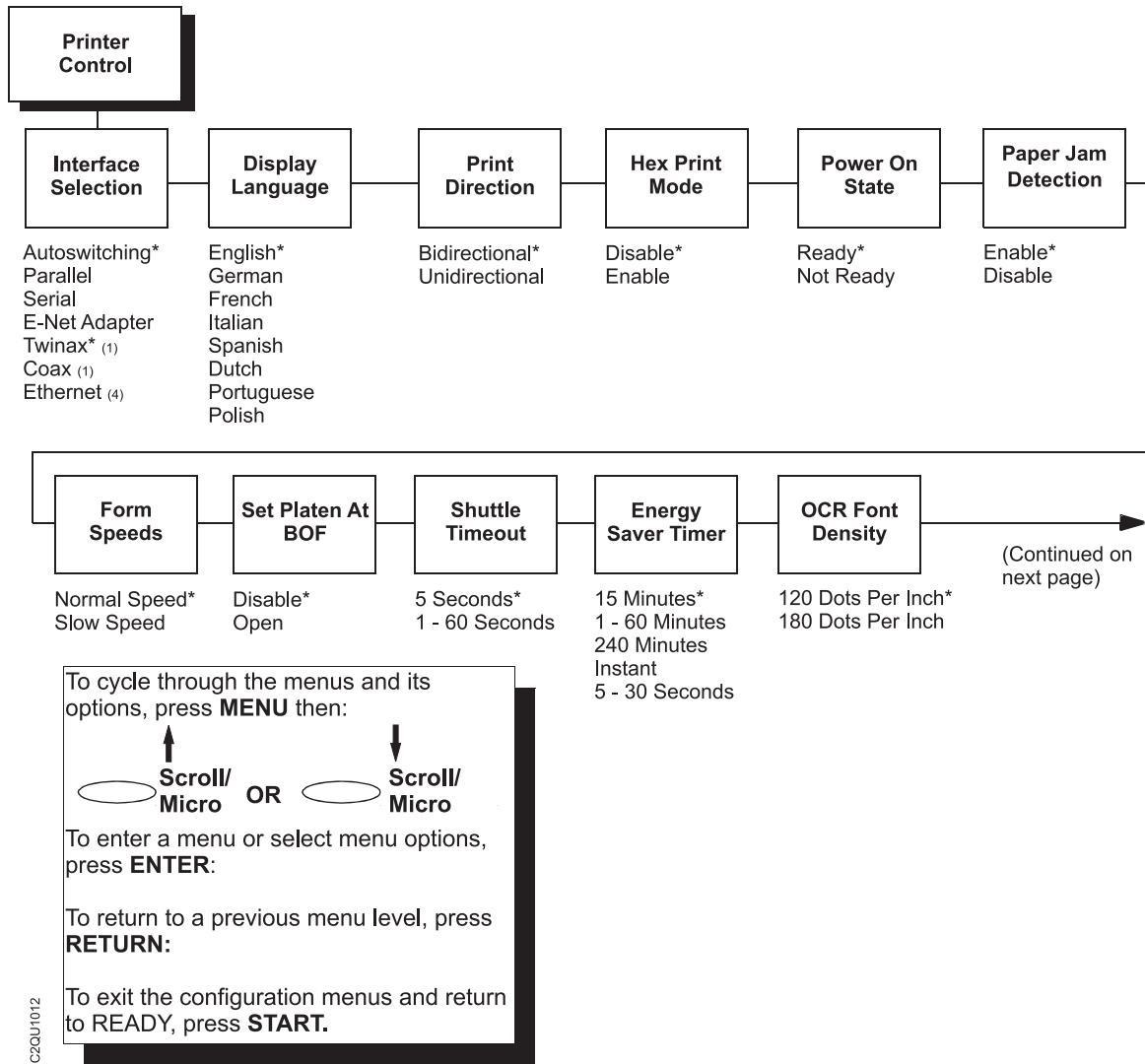

Figure 19. Printer Control Menu

Notes:

1. The Twinax and Coax Interface menus only appear in the menus if the Coax/Twinax feature is installed.
2. Top exit tear path can only be selected on pedestal models.
3. If the Power Paper Stacker is installed.
4. Either the Network Setup menu or the Parallel Interface menu will display. They cannot be displayed at the same time.

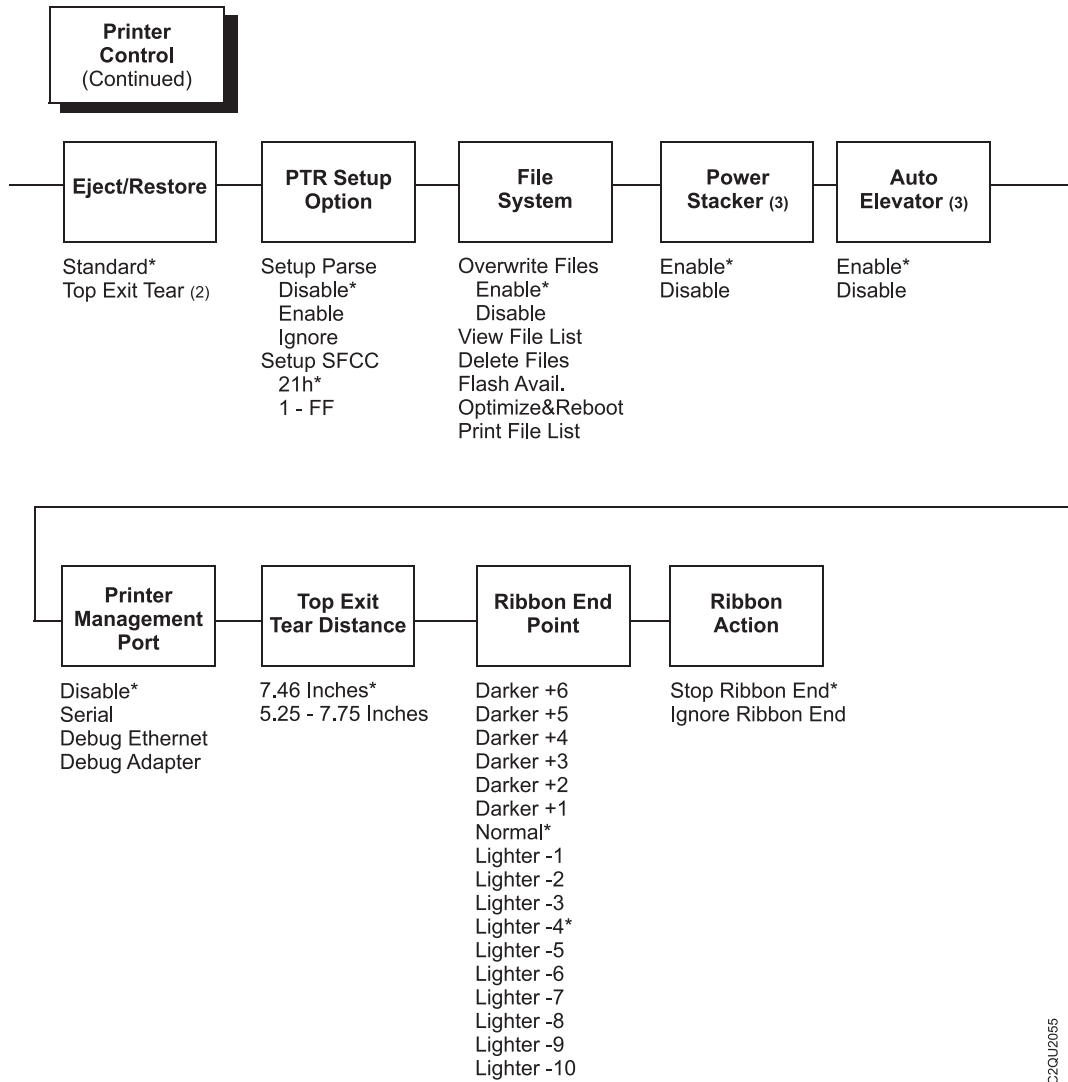

Figure 20. Printer Control Menu (continued)

Notes:

1. The Twinax and Coax Interface menus only appear in the menus if the Coax/Twinax feature is installed.
2. Top exit tear path can only be selected on pedestal models.
3. If the Power Paper Stacker is installed.
4. Either the Network Setup menu or the Parallel Interface menu will display. They cannot be displayed at the same time.

Interface Selection

Interface selection enables or disables physical interfaces for attachment switching. If an interface is disabled, it is set offline and any data received will be ignored.

When Coax or Twinax is selected, a POR status is sent to the host. Selecting Autoswitching provides automatic interface switching among parallel, serial, and either Coax or Twinax communication. Only one interface can be enabled at a time. Configuration of the Auto Switching Hotport is done from the corresponding interface menu, as shown in the following sections.

Note: When used with serial, parallel, and Coax or Twinax non-IPDS emulations, Autoswitching does NOT save the state of each emulation during interface switching. In this case, it is the responsibility of the host application program to initialize the emulation to the desired state as the beginning of each job. It is also the responsibility of the host application program to correctly position the forms at “top of form” and the end of each job. When used with Coax or Twinax IPDS, Autoswitching does save the state of the IPDS emulation during interface switching and will also correctly position the forms at “top of form” at the end of each IPDS job.

Display Language

This parameter selects the language in which the operator panel messages will display.

Print Direction

The PRINT DIRECTION feature affects both print quality and printing speed. By setting this feature, you can configure the printer to print in both directions of the shuttle sweep (Bidirectional), or to print in only one direction (Unidirectional).

You might want to use Unidirectional when printing bar codes, high quality text and graphics, or other printing that requires precise vertical alignment.

Although enabling this feature reduces print speed, it enhances the vertical alignment of dots and produces cleaner, sharper bar codes and text.

- **Bidirectional** (the default) prints all data in both directions of the shuttle sweep. This choice produces higher printing speed.
- **Unidirectional** prints all data in only one direction of the shuttle sweep. This choice produces higher print quality.

Hex Print Mode

A hex code printout (or hex dump) translates all incoming data to hexadecimal equivalents. A hex dump lists each ASCII data character received from the host computer, together with its corresponding two-digit hexadecimal code. Hex dumps can be used to troubleshoot some types of printer data reception problems.

- **Disable** (the default)
- **Enable**

Refer to page 217 to obtain a hex code printout.

Note: Printing in Hex Mode may alter print attributes set at the operator panel or by the host computer. These attributes may need to be reset after exiting Hex Print Mode. The mode is not available when printing IPDS.

Power On State

This parameter allows you to configure the printer to power on in the READY or NOT READY mode.

- **Ready** (the default)
- **Not Ready**

Paper Jam Detection

This parameter determines whether or not paper jam detection is active.

- **Enable** (the default). Detects paper jams.
- **Disables**. Disables paper jam checking to prevent false errors.

Attention: When paper jam detection is disabled, the printer does not monitor paper motion. If a paper jam occurs, the printer ignores the condition and continues to print, possibly causing severe damage to the printer.

Forms Speed

FORMS SPEED affects the speed at which paper moves into the stacking area of the printer.

- **Normal Speed** (the default) will slew and stack paper, such as single-sheet data processing paper, at maximum speed.
- **Slow Speed** will slew and stack at a slower pace. This ensures that forms, such as multiple-sheet (that is, invoice), will stack more neatly.

Set Platen at BOF

Some special forms have perforation areas that are thicker than the rest of the form. Enable this parameter when you are using this type of form. This parameter, when open is selected, allows the platen to open and close when perforations thicker than the rest of a form move across the platen.

To retain print quality with this type of form, set the position of the first and last print lines to avoid printing where paper thickness occurs (before and after the perforation). See "Forms Length" on page 184.

- **Disable** (the default)
- **Open**

Note: When enabling this parameter, you must set the forms length to match the physical distance between perforations.

Shuttle Timeout

The SHUTTLE TIMEOUT parameter determines the amount of time the shuttle will continue running after printing stops. This allows the shuttle to continue moving during the time between print jobs when the print jobs arrive at frequent intervals. Time is saved if the shuttle is still moving when a print job arrives at the printer, since the printer does not have to wait for the shuttle to reach its operating speed.

- **5 Seconds** (the default)
- **1 - 60 Seconds**

Energy Saver Timer

This parameter helps to reduce power consumption when the printer is not in use in order to reduce air pollution caused by power generation. Use of this feature can cut energy use by more than 50 percent.

ENERGY SAVER TIMER determines the amount of time that expires before the printer reduces power after printing stops. The energy saver mode can select an energy saver activation time from instant to 60 minutes. The selections are:

- **15 Minutes** (the default)
- **1 - 60 Minutes**
- **240 Mins**
- **Instant**
- **5 - 30 Seconds**

Note: If the printer enters energy saver mode while NOT READY, the printer will not print any jobs until made READY by pressing the **Start** key.

OCR Font Density

OCR FONT DENSITY determines the print quality for OCR A and OCR B character sets. The following options are available:

- **120 Dots Per Inch** (the default). Vertical is 144; horizontal is 120.
- **180 Dots Per Inch** Vertical is 144; horizontal is 180.

Note: The higher the resolution selected, the slower the print speed. When selecting a resolution, try to balance the resolution quality your application requires with how fast you want the print job to print.

Eject/Restore

The EJECT/RESTORE parameter controls how the printer behaves when the user presses the EJECT key. The following options are available:

- **Standard** (the default)
- **Top Exit Tear** (pedestal models only)

When STANDARD mode is selected, the EJECT key operates as follows:

- Pressing EJECT causes the paper to advance a preset distance of 22 inches.
- Pressing **Ready** or pressing EJECT a second time causes the paper to return to its original position.

Note: If you are using this function to tear off forms, you might want to press **FORM FEED** before using the EJECT/RESTORE function. This will avoid unloading the paper as it is restored to its original position.

When TOP EXIT TEAR mode is selected, the EJECT key operates as follows:

- Pressing EJECT causes the paper to advance the bottom of the last printed form to the tear position, ready for the operator to tear off the printed forms.
- Pressing EJECT a second time causes the paper to move into position such that the top of the first possible form available for printing is positioned ready for printing. (The direction and amount of paper movement will depend on the length of the forms; one or more blank forms will be skipped.)

Note: The TOP EXIT TEAR setting is meaningful only on pedestal model printers. TOP EXIT TEAR cannot be selected on cabinet model printers.

Forms length must be set correctly for the TOP EXIT TEAR mode to function properly.

PTR Setup Option

This option selects the Special Function Control Code (SFCC) for the PTR_SETUP command and functions. The selections for this process are given below.

Setup Parse

This selection is used to enable or disable the PTR Setup Option.

- **Disable** (the default)
- **Enable**
- **Ignore**

Setup SFCC

Sets the legal hex values from X'01' through X'FF'. These represent the ASCII code (in hexadecimal) of the character used as the SFCC.

- **X'21'h** (the default). Corresponds to the "1" character.
- **X'1' — X'FF'**

File System

Provides the means for listing, viewing, and manipulating files in flash memory. The following selections are available.

- **Overwrite.** This selection controls whether the files in flash memory can be overwritten. With the default selection of Enable, files are overwritten. If the selection is disabled, the files can not be overwritten.
- **View Files.** This selection provides a list of files in flash memory. Pressing the **↓ SCROLL/MICRO** key allows you to view the file size.
- **Delete Files.** This selection provides a list of files in flash memory. Pressing the **ENTER** key will delete the displayed file from flash memory.
- **Flash Avail.** This selection provides a list of available files in flash memory.
- **Optimize & Reboot.** Pressing the **ENTER** key with this selection displayed will reclaim flash memory space and reboot the printer.

IMPORTANT: Do not turn the printer off until it has completed the reboot and is either Ready or Not Ready.

- **Print File List.** Pressing the **ENTER** key with this selection displayed will cause the printer to print a summary of files stored in flash memory. Statistics on file system usage are also printed.

Power Stacker

This parameter determines whether or not the power paper stacker is enabled, which is the default, or disabled. This parameter is not presented if the power paper stacker is not installed.

- **Enable** (the default)
- **Disable**

Auto Elevator

This parameter exists only on printers with the power paper stacker installed. The power stacker has a sensor which detects paper movement and raises the stacker as the printed paper stack grows. If the printer has been printing for three minutes continually and the sensor has not detected any growth in the paper stack, the stacker raises itself $\frac{1}{4}$ inch automatically.

- **Enable** (default). The automatic elevator on the power stacker operates normally.
- **Disable**. The stacker does not raise automatically every three minutes and is entirely dependent on the sensor. Disable is used with extremely high-quality print jobs that take a long time to print.

Printer Management Port

Printer Management Port is the port used to connect the printer to the InfoPrint Solutions Company Printer Management Unit (PMU). This menu option is a printer management tool that runs on Host Computers. The options include:

- **Debug Ethernet** (default)
- **Debug Adapter**
- **Disable**
- **Serial**

Top Exit Tear Distance

The eject distance for the EJECT/RESTORE type TOP EXIT TEAR.

- **7.46 Inches** (default)
- **4.50 - 10.50 Inches**

Ribbon End Point

This parameter adjusts the point at which the system will declare the ribbon as being expended. The life count will always be from 100% to 0%, but if a darker setting is selected 0% will be reached more quickly. If a lighter setting is selected, the system will extend the time it takes to reach 0%. The range of values are as follows:

- **-4** (the default)
- **Normal**
- **Darker +1 through Darker +6**
- **Lighter -1 through Lighter -10**

Note: This value can be adjusted at any time and the display will automatically adjust to show the correct percentage relative to the new end point.

Ribbon Action

- **Stop Ribbon End** (the default). Stops ribbon action when ribbon life reaches 0%.
- **Ignore Ribbon End** When selected, the ribbon life display remains on the control panel, and the printer continues to monitor ink consumption.

Configuration Management Menu

The CONFIG. CONTROL menu allows you to control your printer's configurations according to the specifications necessary for your print jobs.

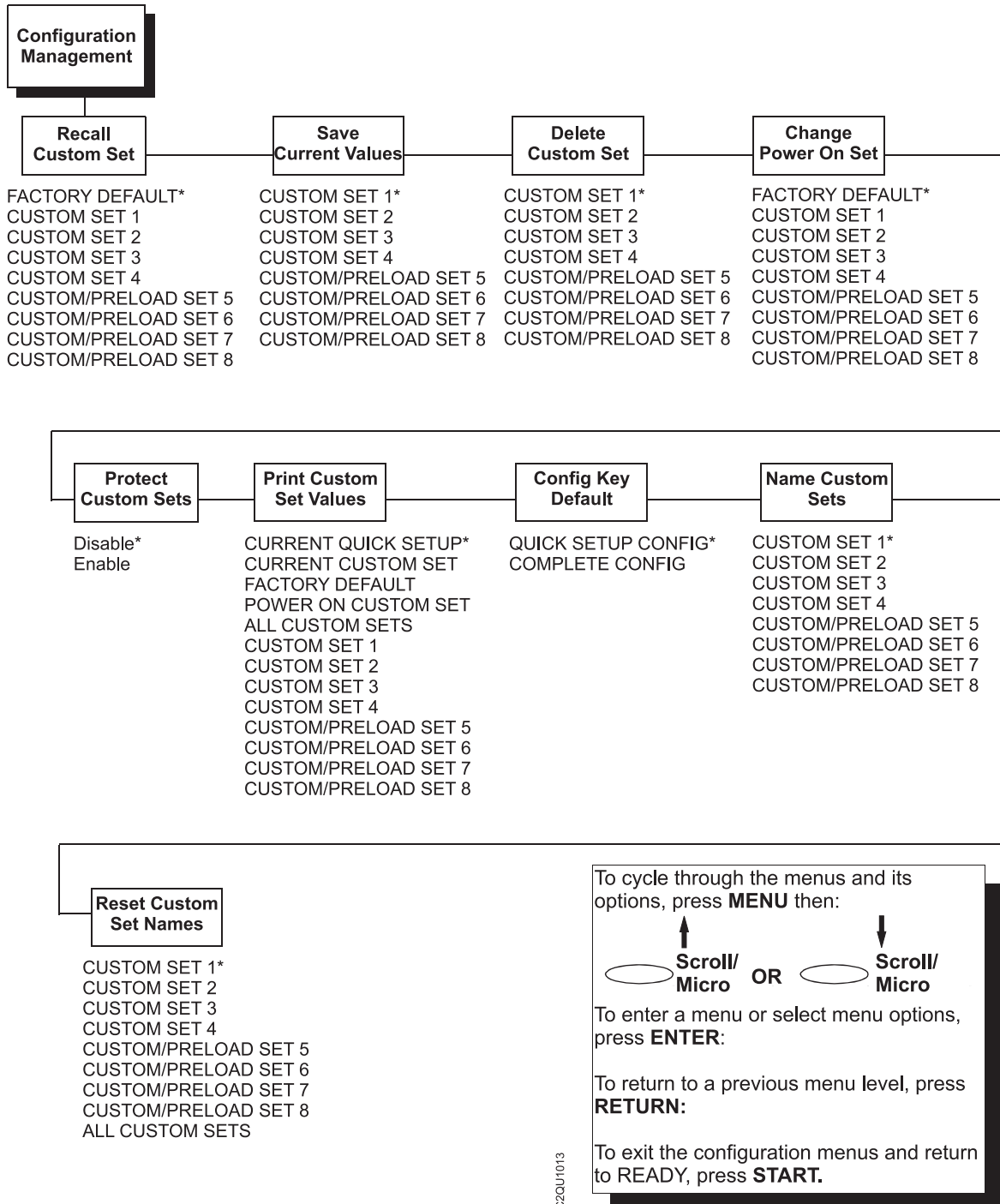

Figure 21. Configuration Management Menu

Recall Custom Set

The printer can store 8 custom sets in NVRAM. This parameter allows you to select and load a specific custom set.

- **Factory Default** (the default). The factory-preset custom set; its parameters cannot be changed. It is always available for loading.

Custom/Preloaded Sets 5-8 contain configuration sets that assist with the installation and configuration of this printer. These sets are preloaded at the factory. If these sets are not used, you can delete them and create new custom sets.

Following is a brief description of Custom/Preloaded Sets 5-8:

- **Custom/Preloaded Set 5** is used when configuring this printer to function like a Printronix printer. This custom set contains ASCII emulations used by Printronix compatible printers along with initial defaults (Overstrike, Auto LF, and so forth). The initial ASCII default emulation is pSeries which may need to be altered for pSeries XQ or Serial Matrix in some applications. This operation is defined only in CT[®] or CT/IPDS builds. For more information, refer to the Configuration Utility Diskette shipped with this printer, or the *InfoPrint 6500 ASCII Programmer's Reference Manual*.
- **Custom/Preloaded Set 6** contains the default settings for an ASCII printer using a set of Epson and Proprinter default values. This could be useful when the printer has the Coax/Twinax feature, but is sometimes run as an ASCII printer. This option is defined only in IGP, CD, and CT/IPDS builds. Refer to the *InfoPrint 6500 Coax/Twinax Programmer's Reference Manual* for more information.
- **Custom/Preloaded Set 7** contains default settings for a Twinax printer without IPDS. This could be useful when the printer contains the IPDS feature, but must occasionally be used as a non-IPDS printer. This option is defined only in CT/IPDS builds. Refer to the *InfoPrint 6500 IPDS Programmer's Reference Manual* or the *InfoPrint 6500 Coax/Twinax Programmer's Reference Manual* for more information.
- **Custom/Preloaded Set 8** sets up the printer for an external CT Interpreter box. This option is defined only for Non-CT IGP and ASCII builds.

Save Current Values

This option allows you to save your custom sets to meet different print job requirements. This eliminates the need to change the parameter settings for each new job.

The custom sets are stored in NVRAM—they will not be lost if you power off the printer.

Factory default is a factory-preset custom set; it cannot be changed or saved.

IMPORTANT: A new custom set will *overwrite* an existing custom set if the **PROTECT CUSTOM SETS** parameter is disabled (for example, a new Custom Set 4 will overwrite an existing Custom Set 4). See the “Protect Custom Sets” in this section.

Delete Custom Set

You can delete one or all of your customized or preloaded custom sets. Factory default is a factory-preset custom set and cannot be changed or deleted.

Change Power On Set

You can specify which of the custom sets will be the power-on custom set. The printer will power on with the factory set values or with one of the customized configurations.

Protect Custom Sets

The PROTECT CUSTOM SETS option specifies whether or not a new custom set can overwrite an existing custom set when you activate the SAVE CURRENT VALUES parameter.

- **Disable** (the default). Turns protection off, allowing you to overwrite existing custom sets.
- **Enable**. Turns protection on, preventing you from overwriting existing custom sets. If you attempt to save to an existing set, the following operator panel message appears:

```
043 CUSTOM SET ALREADY EXISTS  
DELETE FIRST
```

You must delete the existing set before trying to save the new custom set.

Print Custom Set Values

This option is used to print a listing of various stored printer custom sets. It is recommended that you store the printout of the custom sets in a safe place for quick referral.

Config Key Default

This option configures the config key to print either the Quick Setup menu or the full config.

- **Quick Setup Config** (the default). Prints the Quick Setup configuration.
- **Complete Config**. Prints the full configuration.

Name Custom Sets

You may specify a 39-character name which can be used to refer to a custom set. The name you enter for a custom set will be used in the Recall Custom Set, Save Current Values, Delete Custom Set, Change Power On Set, Protect Custom Sets, Print Custom Set Values, and Name Custom Sets menus. The name can only be cleared by using the Reset Custom Set Names menu.

Press the **↑ SCROLL/MICRO** or **↓ SCROLL/MICRO** keys to cycle through the values available for that character at the cursor location. Press the **↑ SCROLL/MICRO** key to move to the next character to be modified. Press the **↓ SCROLL/MICRO** key to go back to a character you have already modified. Continue until you have entered the name you want to give to this custom set, then press **ENTER** to save. The name you entered will now represent this custom set on the printers front panel. To exit this menu without saving, press any key other than the **ENTER** key. The custom set name will revert to the last saved value.

Reset Custom Set Names

You can reset specific custom set names back to the default value of the configuration number.

Twinax Interface Menu

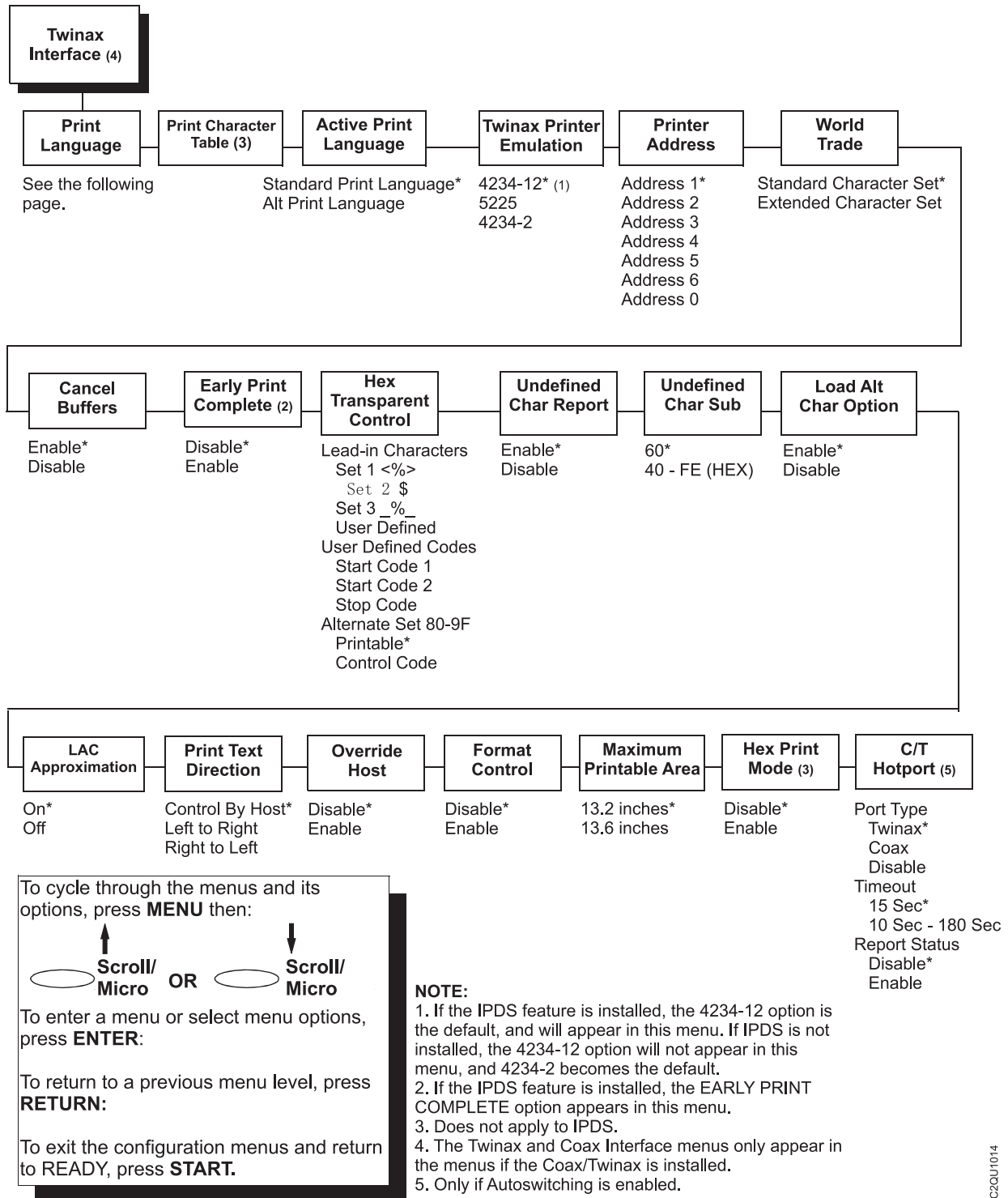

Figure 22. Twinax Interface Menu

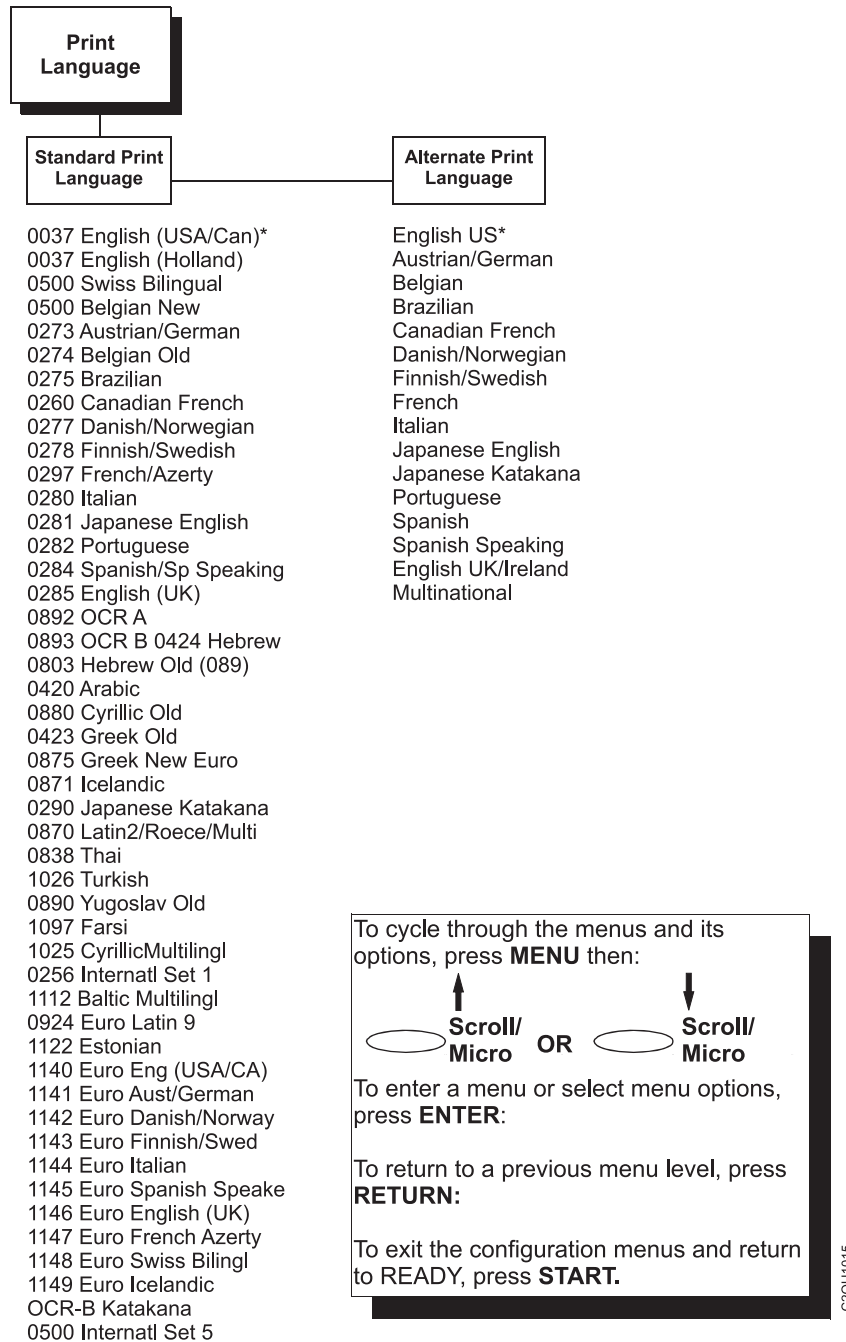

Figure 23. Twinax Interface Menu - Print Language

Print Language

PRINT LANGUAGE specifies the set of print languages used by the printer. Refer to the previous page for print language menus.

- **Standard Print Language** (the default)
- **Alternate Print Language.** Provides code pages compatible with 6408/6412 Model CT0 printers. Use this option with the 5225 printer emulation.

Specifying a print *quality* of OCR A or OCR B will change the print *language* to OCR A or OCR B.

When OCR A or OCR B is selected as the default print language, OCR A and OCR B are the only available values for this print quality. If a different print quality value is desired, the print language must be changed first.

Print Character Table

PRINT CHARACTER TABLE prints out a table of the Twinax interface current character set.

Character sets are shown in the *InfoPrint 6500 Coax/Twinax Programmer's Reference Manual*.

Active Print Language

ACTIVE PRINT LANGUAGE specifies which print language set will be the active set.

- **Standard Print Language** (the default)
- **Alt Print Language**

Twinax Printer Emulation

This parameter defines the printer emulation, as follows:

- **4234-12** (the default)
- **5225**
- **4234-2**

The 4234-12 selection is only present if the IPDS feature is installed. The 4234-12 selection is the default if the IPDS feature is installed, otherwise, the 4234-2 is the default.

After the emulation has been changed, a POR status is sent to the host.

Printer Address

PRINTER ADDRESS allows you to set the device address from 0 through 6. The host directs data and commands on the Twinax line to a specific device based on its unique device address.

After the address has been changed, a POR status is sent to the host.

World Trade

The 5225 emulation has a multinational character set that serves as a base for 14 world trade character set assortments. They are shown in the *InfoPrint 6500 Coax/Twinax Programmer's Reference Manual*.

You can configure the printer to use the Standard Character Set so the printer contains the World Trade character set, such as the Austria/Germany character set. Or, you can select Extended Character Set and use the multinational character set as a base with the selected world trade character set overlaid.

- **Standard Character Set** (the default)
- **Extended Character Set**

Cancel Buffers

CANCEL BUFFERS has the following options:

- **Enable** (the default). Cancels all buffers when a job is put on hold from the host or the **CANCEL** key is pressed.
- **Disable**. Clears the Twinax internal buffer, not the print engine buffers, when a job is put on hold from the host or the **CANCEL** key is pressed.

Early Print Complete

Early Print Complete allows the printer to send Print Complete status to the host before the printer is actually done printing all data. Early Print Complete is only available if the IPDS feature is installed.

- **Disable** (the default). Means the printer will suppress the Early Print Complete response until all printing is complete.
- **Enable**. Means the printer will send an acknowledgement to the host when it is able to accept more data.

Note: When an Early Print Complete is enabled and an error occurs, the data in the printer will remain in the buffer (regardless of the setting of the Cancel Buffer option). It is recommended that local procedures be followed to recover from the error.

Do not select Early Print Complete while a print job is in progress. If this is done you will need to restart the printer.

Hex Transparent Control

This option allows you to enable (the default) or disable additional features that are not available in standard IBM emulations. To access these features, send lead-in character text commands in the data stream. You can also use ASCII codes X'80' through X'9F' as control codes if configured to do so.

Lead-In Characters

The Lead-In Character commands must have a start and end code. Set 1 is the factory default. Three sets (each containing a start and end code) are available:

- **Set 1:** start code = <% (default)
end code = >
- **Set 2:** start code = ~
end code = \$
- **Set 3:** start code = _%
end code = _
- **User Defined**

User Defined Codes

- **Start Code 2:** X'5F' (the default)
- **Start Code 1:** X'5F'
- **Stop code:** X'5B'

The codes can be set to X'40' - X'FF' range

Alternate Set 80 - 9F

This selection determines if ASCII codes X'80' through X'9F' will be used as control codes or printed as standard printable characters.

- **Printable** (the default). Prints the alternate set as standard characters
- **Control Code.** Selects the alternate set to be used as printer control codes.

Undefined Char Report

UNDEFINED CHARACTER REPORTING allows overriding of the host setting of the SGEA (Set Graphic Error Action) command. For more information about the SGEA command, refer to the *InfoPrint 6500 Coax/Twinax Programmer's Reference Manual*.

- **Enable** (the default). The host setting for the SGEA and is used by the printer. If the SGEA command is requested to stop on graphic errors, the printer will stop when a graphic error is detected.
- **Disable**. Ignores the SGEA command from the host. The printer does not stop when an error is detected; instead, it substitutes the character selected in the "UNDEFINED CHARACTER SUBSTITUTION" menu entry.

Undefined Char Sub

UNDEFINED CHARACTER SUBSTITUTION specifies the replacement character to print in place of any unprintable character that is received from the host. The character becomes the printer default when:

- The printer is powered off and then powered on.
- An SGEA command specifies to use the operator panel default.
- The "UNDEFINED CHARACTER REPORTING" option is disabled.

The character code point can be set to the following values:

- X'60' (the default)
- X'40' — X'FE' (HEX)

Load Alt Char Option

The LOAD ALTERNATE CHARACTER (LAC) OPTION allows the host system to load alternate character images into the printer. This may be used for designing graphics, bar codes, and charts, or for printing in foreign languages.

- **Enable** (the default). Prints the LAC character as defined.
- **Disable**. Ignores the LAC definition from the host and prints from the currently selected character set.

LAC Approximation

A process that reorganizes columns of dots so that clean, readable printing is possible.

- **On** (the default). Converts the emulated character cells to standard cells for the 6500-v20 model.
- **Off**. Converts character cells byte by byte and not by LAC approximation.

Print Text Direction

PRINT TEXT DIRECTION specifies the direction in which characters are printed on the page. This allows the printer to print languages that are printed right to left instead of left to right.

- **Control By Host** (the default)
- **Left To Right**
- **Right To Left**

Override Host

OVERRIDE HOST determines whether the printer executes certain commands sent by the host, or continues to use the current printer settings. The following host commands are ignored when OVERRIDE HOST is enabled: line length, forms length, lines per inch (LPI), characters per inch (CPI), print quality, and text orientation (that is, left to right). When OVERRIDE HOST is enabled, these settings retain their operator panel settings.

Note: Host margin and tab settings will be used whether or not OVERRIDE HOST is enabled.

- **Disable** (the default). Allows certain host commands (line length, forms length, LPI, CPI, print quality, and text orientation) to override operator panel settings. Note that the information appearing on the message display may not match the data stream setting. No values will change upon initial selection of the disable option.
- **Enable**. Permits operator panel settings to override host data stream commands.

Format Control

FORMAT CONTROL enables the printer to reflect the same spacing as 6408/6412 Model CT0 printers after absolute and relative move commands are executed. The following options are available:

- **Disable** (the default). Does not reflect distance, generated by the Code V feature, IGP feature, and Hex Transparent control code sequence, in the new position (after absolute and relative move commands are executed).
- **Enable**. reflects 6408/6412 Model CT0 distance, generated by the Code V feature, IGP feature, and Hex Transparent control code sequence, in the new position (after absolute and relative move commands are executed).

Maximum Printable Width

MAXIMUM PRINTABLE WIDTH sets the maximum width of the printer when using a CT host interface.

- **13.2 Inches** (the default)
- **13.6 Inches**

Note: The Twinax interface menu and Coax interface menu option for maximum printable width use the same internal variable. Setting this option in either menu will make it the current setting for the printer, independent of the interface used.

Although the LP+ emulation maintains width in characters, the maximum printable width in characters is controlled by the same internal variable that is set by the Twinax interface menu and Coax interface menu option for maximum printable width option.

Hex Print Mode

When enabled, the HEX PRINT MODE parameter prints the EBCDIC data and control codes received from the host as hex values.

- **Disable** (the default)
- **Enable**

Refer to “Hex Code Printout” on page 217 to obtain a hex code printout.

Note: Printing in Hex Mode may alter print attributes set by the host computer. A power cycle may be required after changing HEX PRINT MODE from enable to disable.

C/T Hotport

Gives the printer the ability to handle multiple data streams simultaneously. It allows the printer to serve hosts attached to the serial, parallel, and either Coax or Twinax ports as if they were the only interface connected.

Port Type

Selects the type of port to be used. The Disable selection disables the port from the hotport process. The available selections are:

- **Twinax** (the default)
- **Coax**
- **Disable**

Note: Changing the Port Type in this menu option also changes the Port Type setting in the Coax Interface Menu.

Timeout

This is the value used by the printer to time out from the current port and check the other ports for data to print. When the printer has not received data from the host after the specified period of time, it needs to Timeout to service the other ports. The available selection are:

- **15 Seconds** (the default)
- **10 to 180 Seconds.**

Report Status

- **Disable** (the default). A fault on the printer is reported only if it occurs on the active port.
- **Enable.** The faults are reported even if the fault is not on the current active port.

Coax Interface Menu

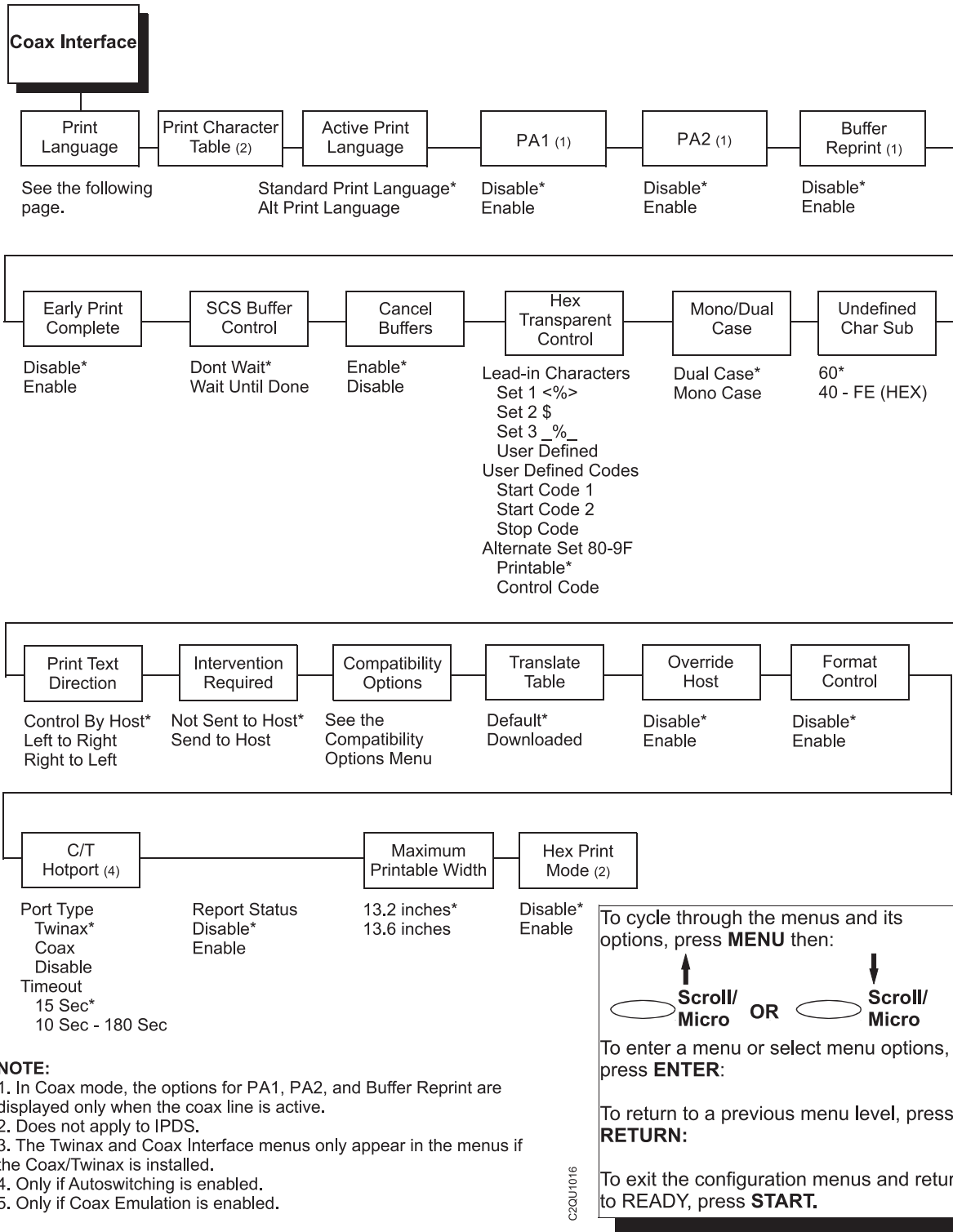

Figure 24. Coax Interface Menu

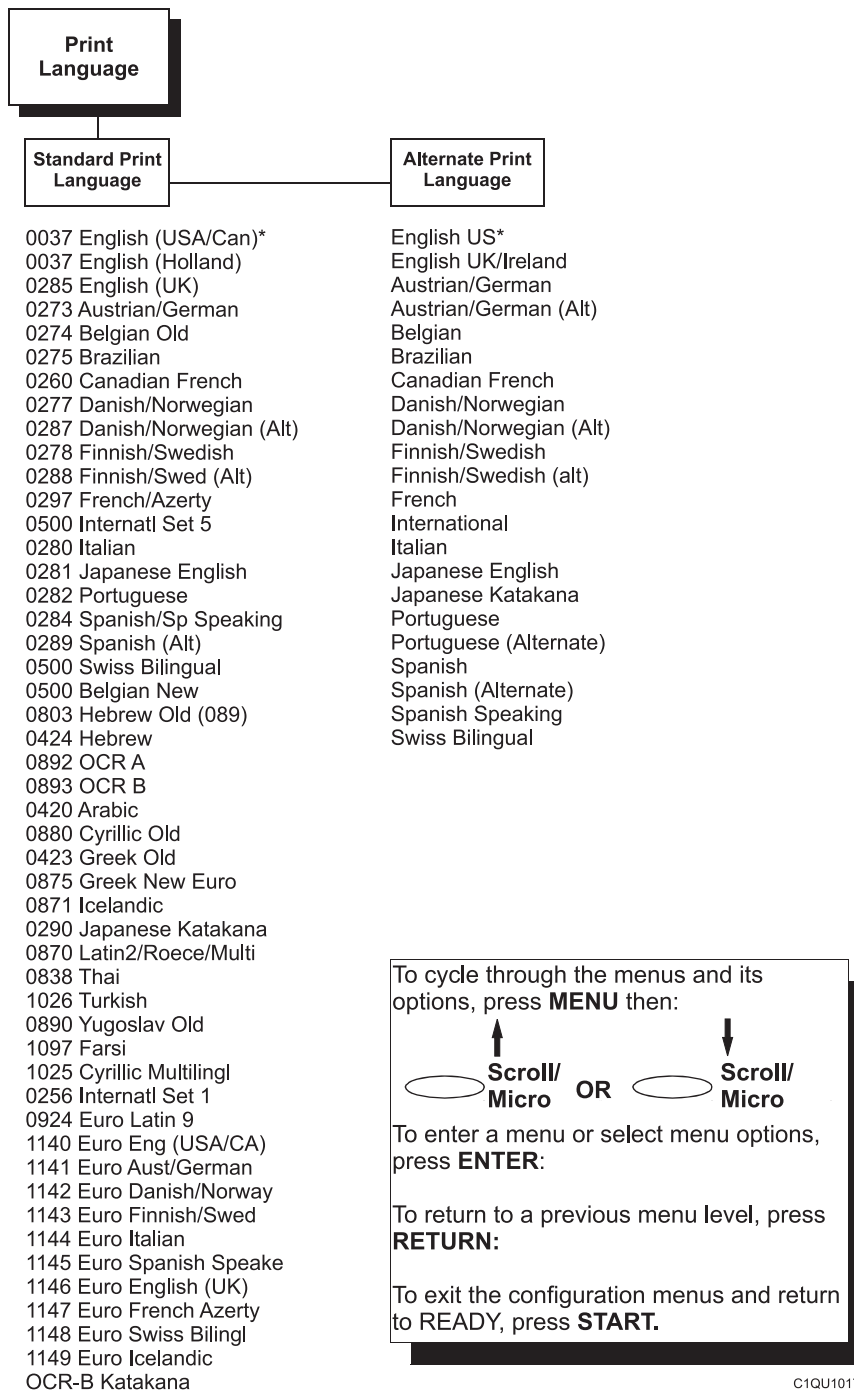

Figure 25. Coax Interface Menu - Print Language

Print Language

PRINT LANGUAGE specifies the set of print languages used by the printer. Refer to the previous page for print language menus.

- **Standard Print Language** (the default)
- **Alternate Print Language.** Provides code pages compatible with 6408/6412 Model CT0 printers. Use this option with the 3287 printer emulation.

Specifying a print *quality* of OCR A or OCR B will change the print language to OCR A or OCR B.

When OCR A or OCR B is selected as the default print language, OCR A and OCR B are the only available values for this parameter. If a different print quality value is desired, the print language must be changed first.

Print Character Table

PRINT CHARACTER TABLE prints out a table of the Coax interface current character set.

All Coax character sets are shown in the *InfoPrint 6500 Coax/Twinax Programmer's Reference Manual*.

Active Print Language

ACTIVE PRINT LANGUAGE specifies which print language set will be the active set.

- **Standard Print Language** (the default)
- **Alternate Print Language**

PA1

PA1 is only valid when the printer is in the NOT READY state and the Coax System Network Architecture Character Set (SCS) data stream is active. This function displays the "PA1 ENABLED" message when the **ENTER** key is pressed and sends a special operator request to the host when the printer is made READY.

- **Disable** (the default)
- **Enable**

Refer to the *InfoPrint 6500 Coax/Twinax Programmer's Reference Manual* for more information about SCS.

Note: Selecting the PA1 menu item again ("PA1 DISABLED" appears on the operator panel) or selecting the PA2 menu item will reset the pending PA1 function.

PA2

PA2 is only valid when the printer is in the NOT READY state and the Coax SCS data stream is active. This function displays the "PA2 ENABLED" message when the ENTER key is pressed and sends a special operator request to the host when the printer is made READY.

- **Disable** (the default)
- **Enable**

Note: Selecting the PA2 menu item again ("PA2 DISABLED" appears on the operator panel) or selecting the PA1 menu item will reset the pending PA2 function.

Buffer Reprint

This option is only valid when the printer is in the NOT READY state and the Coax SCS data stream is active. The printer displays the "ENABLED" message when the ENTER key is pressed, and sends an Intervention Required Status to the host when the printer goes to READY state.

- **Disable** (the default)
- **Enable**

Note: Selecting the Buffer Reprint menu item again ("DISABLED" appears on the operator panel) will reset the Buffer Reprint function.

Early Print Complete

Early Print Complete capability allows the printer to send Print Complete status to the host before the printer is actually done printing all data.

- **Disable** (the default). The printer will suppress the Early Print Complete response until all printing is complete.
- **Enable**. The printer will send an acknowledgement to the host when it is able to accept more data.

Note: When an Early Print Complete is enabled and an error occurs, the data in the printer will remain in the buffer (regardless of the setting of the Cancel Buffer option). It is recommended that local procedures be followed to recover from the error.

Do not select Early Print Complete while a print job is in progress. If this is done you will need to restart the printer.

SCS Buffer Control

This option is used in Coax LU1/SCS mode only.

- **Don't Wait** (the default). The printer does not wait for the job to be printed before sending the print completion to the host.
- **Wait Until Done**. The printer waits for the job to print before sending the print completion to the host.

This option speeds up the LU1 job printing for short jobs. If you select "Don't Wait", there is a risk that you may not be able to recover the print job when the printer has fault.

Cancel Buffers

CANCEL BUFFERS has the following options:

- **Enable** (the default). Cancels all buffers when a job is put on hold from the host or when the **CANCEL** key is pressed.
- **Disable**. Clears the Coax internal buffer, not the print engine buffers, when a job is put on hold from the host or when the **CANCEL** key is pressed.

Hex Transparent Control

You can enable additional features that are not available in standard IBM emulations. To access these features, send lead-in character text commands in the data stream. You can also use ASCII codes X'80' through X'9F' as control codes if configured to do so.

Lead-In Characters

The Lead-In Character commands must have a start and end code. Set 1 is the factory default. Three sets (each containing a start and end code) are available:

- **Set 1:** start code = <%
end code = >
- **Set 2:** start code = ~
end code = \$
- **Set 3:** start code = _%
end code = _
- **User Defined**

User Defined Codes

- **Start Code 2:** X'5F'* (the default)
- **Start Code 1:** X'5F'
- **Stop code:** X'5B'

The codes can be set to X'40' - X'FF' range

Alternate Set 80 - 9F

This selection determines if ASCII codes X'80' through X'9F' will be used as control codes or printed as standard printable characters.

- **Printable** (the default). Prints the alternate set as standard characters
- **Control Code**. Selects the alternate set to be used as printer control codes.

Mono/Dual Case

MONO/DUAL CASE specifies the font as MONO Case or DUAL Case (the default). It is available only in non-SCS mode. The host will be notified of the change when the printer is made READY. If the character set is one of the following "right to left" sets, MONO CASE prints the same as DUAL CASE: Katakana, Hebrew, Hebrew Old, and Farsi.

- **Dual Case** (the default)
- **Mono Case**

SCS (System Network Architecture Character String) Mode is controlled by the host computer. Refer to the *InfoPrint 6500 Coax/Twinax Programmer's Reference Manual* for more information about non-SCS mode.

Undefined Char Sub

UNDEFINED CHARACTER SUBSTITUTION specifies the replacement character to print in place of any unprintable character that is received from the host. The character code point can have the following value:

- **X'60' Hex** (the default)
- **X'40' — X'FE' Hex**

Print Text Direction

PRINT TEXT DIRECTION specifies the direction in which characters are printed on the page. This allows the printer to print languages which are printed right to left instead of left to right.

- **Control By Host** (the default)
- **Left To Right**
- **Right To Left**

The "CONTROL BY HOST" option allows printers configured as a 4234 to use the "SET TEXT ORIENTATION" command from the host.

When a RIGHT TO LEFT language is selected, the host will be notified of print direction changes when the printer is made READY.

Image Buffer Size

IMAGE BUFFER SIZE (screen buffer size) allows you to select the following image buffer sizes:

- **4K** (the default)
- **2K**

A POR status is sent to the host when the printer is made READY.

Intervention Required

Select from the following:

- **Not Send To Host** (the default)
- **Send To Host**. The printer sends a signal to the host computer when any of the following occur:
 - Printer faults occur.
 - Hold mode timeout occurs.

If not selected, the printer will only send the signal on printer faults that cause data loss (paper jam, ribbon stall, online platen open, and so forth).

Compatibility Options

See “Compatibility Options Menu” on page 76.

Translate Table

This parameter defines which translate table to use for printing. The following options are available:

- **Default** (the default). Translates data by using the default table of the current character set.
- **Downloaded** Translates data from EBCDIC to internal code by using the downloaded translate table.

Override Host

OVERRIDE HOST determines whether the printer executes certain commands sent by the host, or continues to use the current settings. The following host commands are ignored when OVERRIDE HOST is enabled: line length, forms length, lines per inch (LPI), characters per inch (CPI), print quality, and text orientation (that is, left to right). When OVERRIDE HOST is enabled, these settings retain their operator panel settings.

- **Disable** (the default). Allows certain host commands (line length, forms length, LPI, CPI, print quality, and text orientation) to override operator panel settings. Note that the information appearing on the message display may not match the data stream setting. No values will change upon initial selection of the disable option.
- **Enable**. Permits operator panel settings to override host data stream commands.

Format Control

FORMAT CONTROL enables the printer to reflect the same spacing as 6408/6412 Model CT0 printers after absolute and relative move commands are executed. The following options are available:

- **Disable** (the default). Does not reflect distance, generated by the Code V feature, IGP feature, and Hex Transparent control code sequence, in the new position (after absolute and relative move commands are executed).
- **Enable**. Reflects 6408/6412 Model CT0 distance, generated by the Code V feature, IGP feature, and Hex Transparent control code sequence, in the new position (after absolute and relative move commands are executed).

C/T Hotport

Gives the printer the ability to handle multiple data streams simultaneously. It allows the printer to serve hosts attached to the serial, parallel, and either Coax or Twinax points as if they were the only interface connected.

Port Type

Selects the type of port to be used. The Disable selection disables the port from the hotport process. The available selections are:

- **Twinax** (the default)
- **Coax**
- **Disable**

Note: Changing the Port Type in this menu option also changes the Port Type setting in the Twinax Interface Menu.

Timeout

This is the value used by the printer to time out from the current port and check the other ports for data to print. When the printer has not received data from the host after the specified period of time. It needs to Timeout to service the other ports. The available selections are:

- **15 Seconds** (the default)
- **10 to 180 Seconds**.

Report Status

- **Disable** (the default). A fault on the printer is reported on if it occurs on the active port.
- **Enable**. The faults are reported even if the fault is not on the current active port.

Maximum Printable Width

MAXIMUM PRINTABLE WIDTH sets the maximum width of the printer when using a CT host interface.

- **13.2 Inches** (the default)
- **13.6 Inches**

Note: The Twinax interface menu and Coax interface menu option for maximum printable width use the same internal variable. Setting this option in either menu will make it the current setting for the printer, independent of the interface used.

Although the LP+ emulation maintains width in characters, the maximum printable width in characters is controlled by the same internal variable that is set by the Twinax interface menu and Coax interface menu option for maximum printable width option.

Hex Print Mode

When enabled, the HEX PRINT MODE parameter prints the EBCDIC data and control codes received from the host as hex values. Refer to “Hex Code Printout” on page 217 to obtain a hex code printout. Disable is the default condition.

- **Disable** (the default)
- **Enable**

Note: Printing in Hex Mode may alter print attributes set by the host computer. A power cycle may be required after changing HEX PRINT MODE from enable to disable.

Compatibility Options Menu

The Compatibility Options menu allows you to select special printer functions in the non-SCS mode, based on the capabilities of the printer emulated.

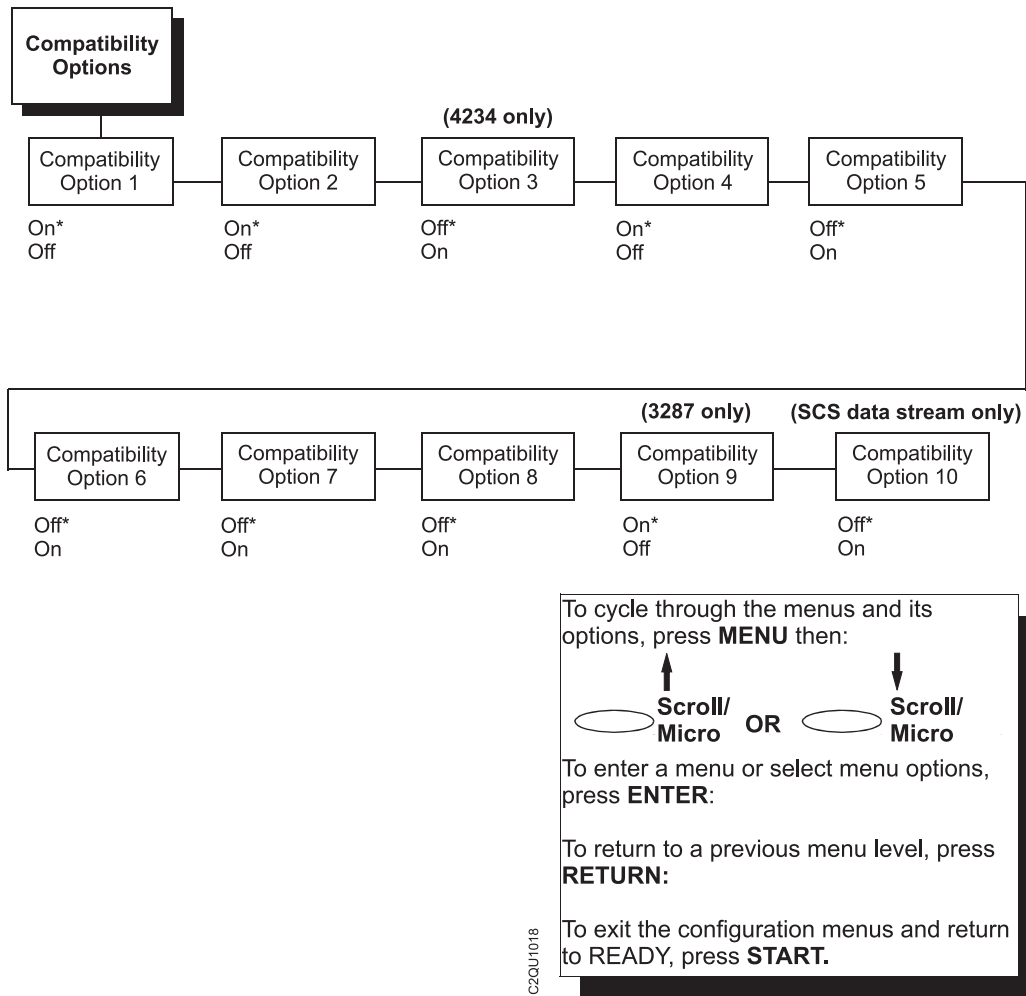

Figure 26. Compatibility Options Menu

Compatibility Option 1: Carriage Return at MPP+1

MPP is Maximum Print Position, which is also known as line length. OPTION 1 controls a carriage return at the end of a print line and at MPP+1.

- **ON** (the default) Produces a carriage return to the first print position of the next line.
- **OFF**. Produces a carriage return to the first print position of the current line.

Compatibility Option 2: New Line at MPP+1

NEW LINE AT MPP+1 controls how many lines are skipped when the carriage returns to a new line.

- **ON** (the default). Moves to the first print position two lines down from the current position.
- **OFF**. Moves to the first print position of the next print line.

Compatibility Option 3: Position After Form Feed (4234 only)

POSITION AFTER FORM FEED allows you to select the location of the print position after a form feed command is sent.

- **OFF** (the default). Sets the printer to print at position 2 of the first print line on the next form.
- **ON**. Sets the printer to print at print position 1 of the first print line on the next form.

Compatibility Option 4: Form Feed at End of Print Buffer

FORM FEED AT END OF PRINT BUFFER determines the print line position when a form feed command is the last code encountered in the print buffer.

- **ON** (the default). Moves to the first print position on the second line of the next form.
- **OFF**. Moves to the first print position on the first line of the next form.

Note: This option is ignored if Compatibility Option 7 is on.

If configured as a 3287, and a form feed occurs in the middle of a print buffer, the printer defaults to the first print position on the second line of the next form, regardless of the setting of this option.

Compatibility Option 5: Null Suppression

NULL SUPPRESSION will either treat nulls as blank spaces or ignore them. If nulls are ignored, the print position does not move.

- **OFF** (the default). Ignores nulls.
- **ON**. Treats nulls as blank spaces.

Compatibility Option 6: Form Feed Command Position

FORM FEED COMMAND POSITION determines if the position of a form feed command affects its execution.

- **OFF** (the default). Performs a form feed only if it occurs at the first print position in a line or at Maximum Print Position +1. (The Maximum Print Position is the line length.) A form feed command at any other position is recognized as a blank.
- **ON**. Allows the printer to perform a form feed command anywhere in the data stream.

Compatibility Option 7: Automatic Form Feed at End of Print Buffer

AUTOMATIC FORM FEED AT[®] END OF PRINT BUFFER specifies whether or not to perform an automatic form feed at the end of a print buffer.

- **OFF** (the default). Performs an automatic new line command after completing a print buffer (unless a form feed, new line, or carriage return command was the last one executed). The printer is set to print at print position 1 of the next line.
- **ON**. Performs an automatic form feed after completing a print buffer (unless a form feed command was the last one in the buffer). The printer is set to print at print position 1 of the first line of the next form.

Compatibility Option 8: Automatic FF After Operator-Initiated Copy

This option determines the print position after an operator-initiated local copy (print screen function).

- **OFF** (the default). Performs an automatic new line command after completing a print buffer (unless a new line, form feed or carriage return command was the last one executed). The printer is set to print at print position 1 of the next line.
- **ON**. Performs an automatic form feed command unless a form feed was the last one executed. The printer is set to print at print position 1 of the first line on the next form.

**Compatibility Option 9:
CR, EM, and NL (3287 only)**

CR (Carriage Return), EM (Error Message), and NL (New Line) specify that the printer treat the CR, EM, and NL control codes either as spaces or as control codes.

- **ON** (the default). Treats the CR, EM and NL commands as control codes.
- **OFF**. Treats the CR, EM and NL commands as spaces.

**Compatibility Option 10:
Bottom Margin (SCS data stream only)**

Any bottom margin specified or implied by a host command will be overridden, causing the operator panel bottom margin value to be used

- **OFF** (the default). Ignores the operator panel bottom margin value.
- **ON**. Forces the bottom margin to the value specified by the operator panel.

Note: If Bottom Margin is ON, the operator can enter a bottom margin; the top margin will be forced to zero. If it is OFF, the operator panel bottom margin is forced to zero.

5250 Interface Menu

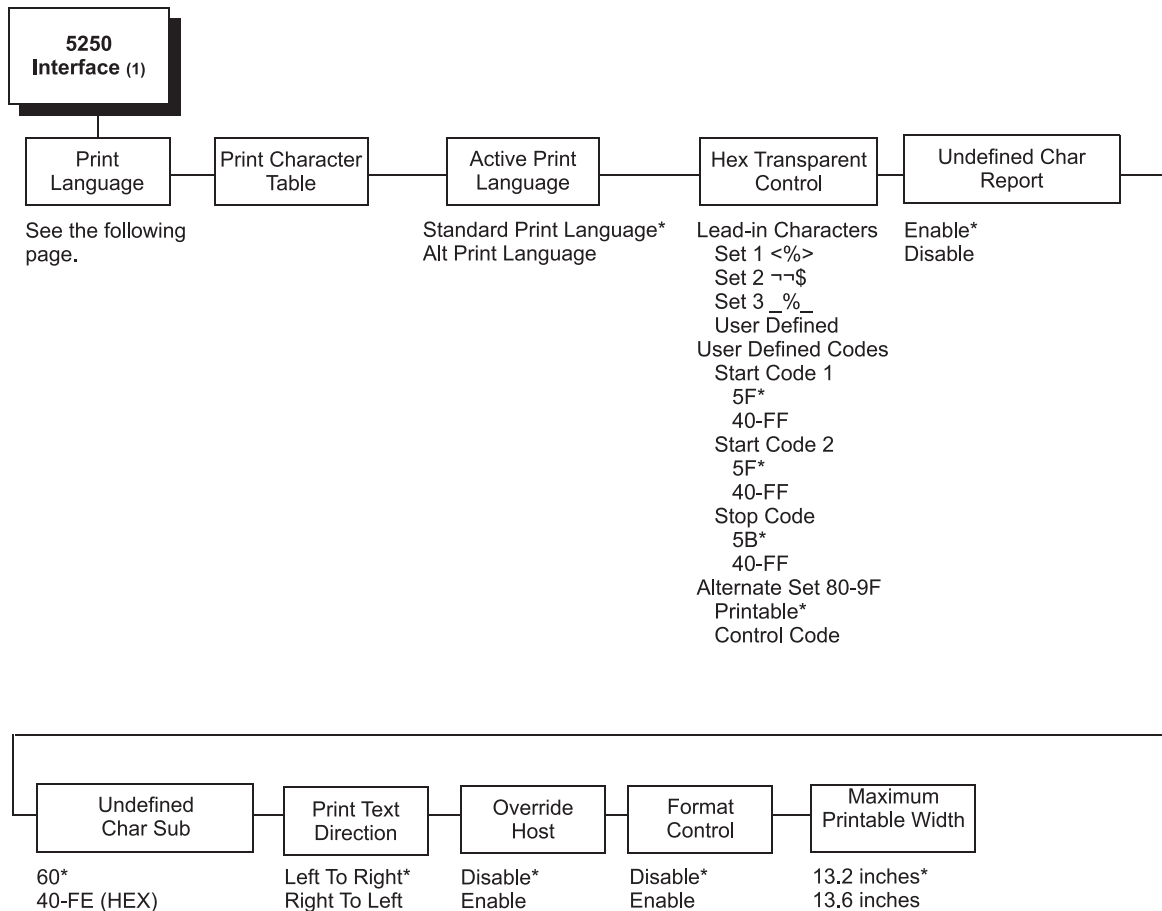

To cycle through the menus and its options, press **MENU** then:

↑ **Scroll/ Micro** OR **Scroll/ Micro** ↓

To enter a menu or select menu options, press **ENTER**:

To return to a previous menu level, press **RETURN**:

To exit the configuration menus and return to READY, press **START**.

C2QJ1019

Notes:

1. This menu only appears if the TN5250/3270 option is installed.

Figure 27. 5250 Interface Menu



Figure 28. 5250 Interface Menu - Print Language

Print Language

PRINT LANGUAGE specifies the set of print languages used by the printer. Refer to the previous page for print language menus.

- **Standard Print Language** (the default)
- **Alternate Print Language** Provides code pages compatible with 6408/6412 Model CT0 printers.

Specifying a print *quality* of OCR A or OCR B will change the print *language* to OCR A or OCR B.

When OCR A or OCR B is selected as the default print language, OCR A and OCR B are the only available values for this print quality. If a different print quality value is desired, the print language must be changed first.

Print Character Table

PRINT CHARACTER TABLE prints out a table of the 5250 interface current character set.

Character sets are shown in the *InfoPrint 6500 Coax/Twinax Programmer's Reference Manual*.

Active Print Language

Selects which group of print language sets (Standard or Alternate) will be active.

- **Standard Print Language** (the default)
- **Alternate Print Language**

Hex Transparent Control

This option allows you to enable (the default) or disable additional features that are not available in standard IBM emulations. To access these features, send lead-in character text commands in the data stream. You can also use ASCII codes X'80' through X'9F' as control codes if configured to do so.

Lead-In Characters

The Lead-In Character commands must have a start and end code. Set 1 is the factory default. Three sets (each containing a start and end code) are available:

- **Set 1:** start code = <% (default)
end code = >
- **Set 2:** start code = ␣
end code = \$
- **Set 3:** start code = _%
end code = _
- **User Defined**

User Defined Codes

- **Start Code 2:** X'5F' (the default)
- **Start Code 1:** X'5F' (the default)
- **Stop Code:** X'5B' (the default)

The codes have a range of X'40' - X'FF'.

Alternate Set 80 - 9F

This selection determines if ASCII codes X'80' through X'9F' will be used as control codes or printed as standard printable characters.

- **Printable** (the default). Prints the alternate set as standard characters
- **Control Code.** Selects the alternate set to be used as printer control codes.

Undefined Char Reporting

UNDEFINED CHARACTER REPORTING allows overriding of the host setting of the SGEA (Set Graphic Error Action) command. For more information about the SGEA command, refer to the *InfoPrint 6500 Coax/Twinax Programmer's Reference Manual*.

- **Enable** (the default). The host setting for the SGEA and is used by the printer. If the SGEA command is requested to stop on graphic errors, the printer will stop when a graphic error is detected.
- **Disable.** Ignores the SGEA command from the host. The printer does not stop when an error is detected; instead, it substitutes the character selected in the "UNDEFINED CHARACTER SUBSTITUTION" menu entry.

Undefined Char Sub

UNDEFINED CHARACTER SUBSTITUTION specifies the replacement character to print in place of any unprintable character that is received from the host. The character becomes the printer default when:

- The printer is powered off and then powered on.
- An SGEA command specifies to use the operator panel default.
- The “UNDEFINED CHARACTER REPORTING” option is disabled.

The character code point can be set to the following values:

- X'60' (the default)
- X'40' – X'FE' (HEX)

Print Text Direction

Specifies the direction in which text is printed on the page. This allows the printer to print languages which are printed right to left instead of left to right.

- **Left to Right** (the default)
- **Right to Left**. When a right to left language is selected, the host will be notified of print direction changes when the printer is put online.

Override Host

Determines whether the printer executes certain commands sent by the host, or continues to use the current printer settings. The following host commands are ignored when OVERRIDE HOST is enabled: line length, forms length, lines per inch (LPI), characters per inch (CPI), print quality, and text orientation (that is, left to right). When OVERRIDE HOST is enabled, these settings retain their operator panel settings.

Note: Host margin and tab settings will be used whether or not OVERRIDE HOST is enabled.

- **Disable** (the default). Allows certain host commands (line length, forms length, LPI, CPI, print quality, and text orientation) to override operator panel settings. Note that the information appearing on the message display may *not* match the data stream setting. No values will change upon initial selection of the disable option.
- **Enable**. Permits operator panel settings to override host data stream commands.

Format Control

Enables the printer to reflect the same spacing as 6408/6412 Model CT0 printers after absolute and relative move commands are executed. The following options are available:

- **Disable** (the default) does not reflect distance, generated by the Code V feature, IGP feature, and Hex Transparent control code sequence, in the new position (after absolute and relative move commands are executed).
- **Enable**. Reflects 6408/6412 Model CT0 distance, generated by the Code V feature, IGP feature, and Hex Transparent control code sequence, in the new position (after absolute and relative move commands are executed).

Maximum Printable Width

Sets the maximum width of the printer when using a CT host interface.

- **13.2 Inches** (the default)
- **13.6 Inches**

Note: The 5250 interface menu and 3270 interface menu option for maximum printable width use the same internal variable. Setting this option in either menu will make it the current setting for the printer, independent of the interface used.

Although the LP+ emulation maintains width in characters, the maximum printable width in characters is controlled by the same internal variable that is set by the 5250 interface menu and 3270 interface menu option for maximum printable width option.

C/T Hotport

Gives the printer the ability to handle multiple data streams simultaneously. It allows the printer to serve hosts attached to the serial, parallel, and either Coax or Twinax ports as if they were the only interface connected.

Port Type

Selects the type of port to be used. The Disable selection disables the port from the hotport process. The available selections are:

- **Twinax** (the default)
- **Coax**
- **Disable**

Note: Changing the Port Type in this menu option also changes the Port Type setting in the Coax Interface Menu.

Timeout

This is the value used by the printer to time out from the current port and check the other ports for data to print. When the printer has not received data from the host after the specified period of time, it needs to Timeout to service the other ports. The available selections are:

- **15 Seconds** (the default)
- **10 to 180 Seconds.**

Report Status

- **Disable** (the default). A fault on the printer is reported only if it occurs on the active port.
- **Enable.** The faults are reported even if the fault is not on the current active port.

3270 Interface Menu

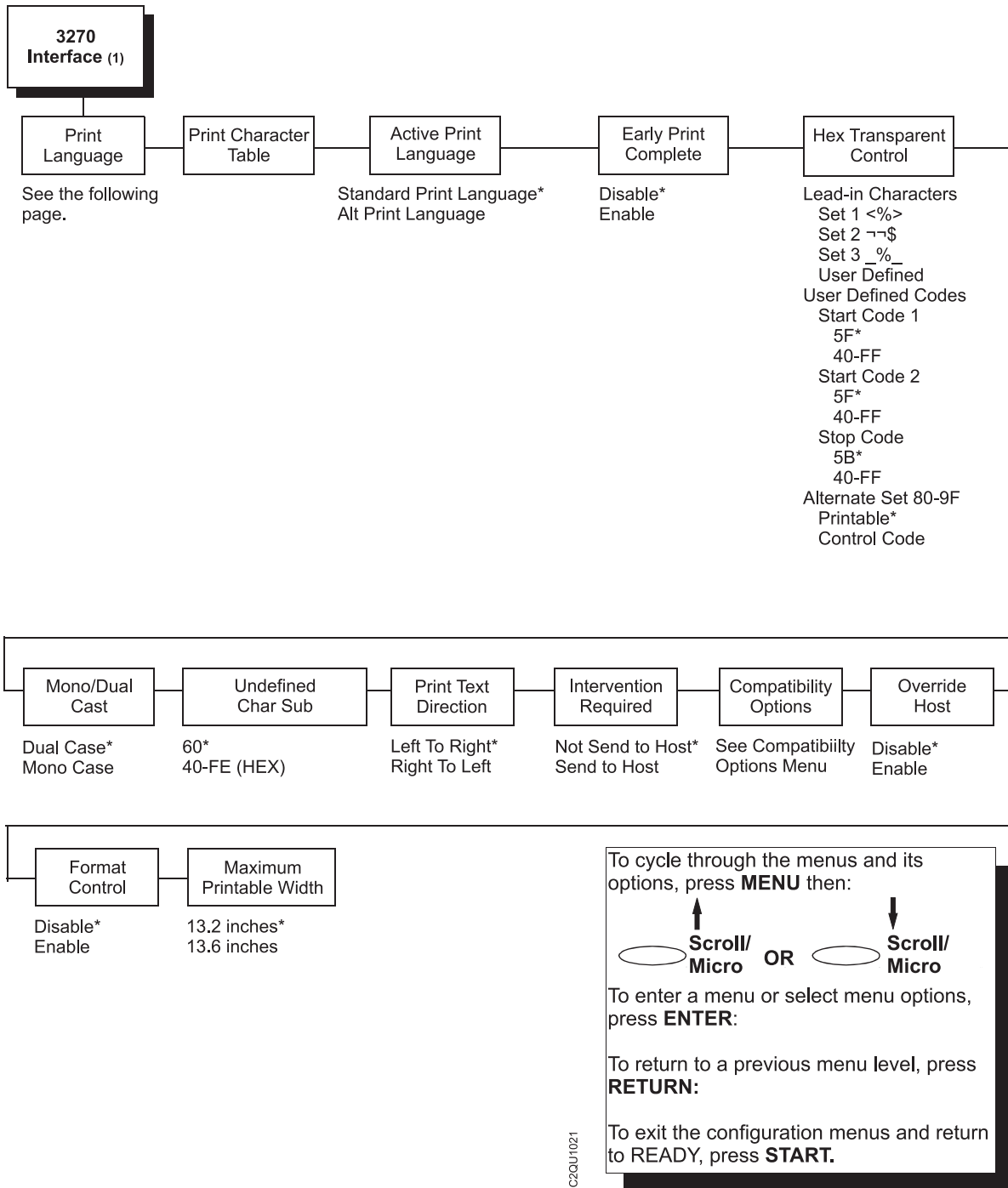

Notes:

1. This menu appears only if the TN5250/3270 option is installed.

Figure 29. 3270 Interface Menu



Figure 30. 3270 Interface Menu - Print Language

Print Language

PRINT LANGUAGE specifies the set of print languages used by the printer. Refer to the previous page for print language menus.

Specifying a print *quality* of OCR A or OCR B will change the print *language* to OCR A or OCR B.

When OCR A or OCR B is selected as the default print language, OCR A and OCR B are the only available values for this print quality. If a different print quality value is desired, the print language must be changed first.

Print Character Table

PRINT CHARACTER TABLE prints out a table of the 3270 interface current character set.

Character sets are shown in the *InfoPrint 6500 Coax/Twinax Programmer's Reference Manual*

Active Print Language

Selects which group of print language sets (standard or alternate) will be active.

- **Standard Print Language** (the default)
- **Alternate Print Language**

Early Print Complete

Early print complete allows the printer to indicate to the host that print has completed before it actually occurs. This can improve throughput in certain modes.

- **Disable** (the default). The printer will not respond until printing is complete.
- **Enable**. The printer will indicate to the host that it is able to accept more data before printing is complete.

Note: Early Print Complete should only be enabled to improve performance when running DSC (LU0) or DSE (LU3). This does not apply in SNA (LU1) mode. Interventions such as forms jams and end of forms will not be sent to the host when Early Print Complete is enabled.

Hex Transparent Control

You can enable additional features that are not available in standard IBM emulations. To access these features, send lead-in character text commands in the data stream. You can also use ASCII codes X'80' through X'9F' as control codes if configured to do so.

Lead-In Characters

The Lead-In Character commands must have a start and end code. Set 1 is the factory default. Three sets (each containing a start and end code) are available:

- **Set 1:** start code = <% (default)
end code = >
- **Set 2** start code = ␣
end code = \$
- **Set 3** start code = _%
end code = _
- **User Defined**

User Defined Codes

- **Start Code 2:** X'5F' (the default)
- **Start Code 1:** X'5F' (the default)
- **Stop Code:** X'5B' (the default)

The codes have a range of X'40' - X'FF'.

Alternate Set 80 - 9F

This selection determines if ASCII codes X'80' through X'9F' will be used as control codes or printed as standard printable characters.

- **Printable** (the default). Prints the alternate set as standard characters
- **Control Code.** Selects the alternate set to be used as printer control codes.

Mono/Dual Case

Specifies the font as Mono or Dual case. This option is available only in non-SCS mode. The host will be notified of the change when the printer is placed online. Mono Case prints the same as Dual Case if the character set is one of the following "right to left" sets: Katak., Hebrew, Old Hebrew, and Farsi.

SCS (System Network Architecture Character String) mode is controlled by the host computer.

- **Dual Case** (the default)
- **Mono Case**

Undefined Char Substitution

UNDEFINED CHARACTER SUBSTITUTION specifies the replacement character to print in place of any unprintable character that is received from the host. The character becomes the printer default when:

- The printer is powered off and then powered on.
- An SGEA command specifies to use the operator panel default.
- The “UNDEFINED CHARACTER REPORTING” option is disabled.

The character code point can be set to the following values:

- X'60' (the default)
- X'40' – X'FE' (HEX)

Print Text Direction

Specifies the direction in which characters are printed on the page. This allows the printer to print languages which are printed right to left instead of left to right.

- **Left to Right** (the default).
- **Right to Left.** When a right to left language is selected, the host will be notified of print direction changes when the printer is put online.

Intervention Required

Select from the following:

- **Not Send To Host** (the default)
- **Send To Host.** The printer sends a signal to the host computer when any of the following occur:
 - Printer faults occur.
 - Hold mode timeout occurs.

If not selected, the printer will only send the signal on printer faults that cause data loss (paper jam, ribbon stall, online platen open, and so forth).

Override Host

Determines whether the printer executes certain commands sent by the host, or continues to use the current settings. The following host commands are ignored when OVERRIDE HOST is enabled: line length, forms length, lines per inch (LPI), characters per inch (CPI), print quality, and text orientation (that is, left to right). When OVERRIDE HOST is enabled, these settings retain their operator panel settings.

- **Disable** (the default). Allows certain host commands (line length, forms length, LPI, CPI, print quality, and text orientation) to override operator settings. Note that the information appearing on the message display may *not* match the data stream setting. No values will change upon initial selection of the disable option.
- **Enable**. Permits operator panel settings to override host data stream commands.

Format Control

Enables the printer to reflect the same spacing as 6408/6412 Model CT0 printers after absolute and relative move commands are executed. The following options are available:

- **Disable** (the default). Does not reflect distance, generated by the Code V feature, IGP feature, and Hex Transparent control code sequence, in the new position (after absolute and relative move commands are executed.)
- **Enable**. Reflects 6408/6412 Model CT0 distance, generated by the Code V feature, IGP feature, and Hex Transparent control code sequence, in the new position (after absolute and relative move commands are executed.)

C/T Hotport

Gives the printer the ability to handle multiple data streams simultaneously. It allows the printer to serve hosts attached to the serial, parallel, and either Coax or Twinax ports as if they were the only interface connected.

Port Type

Selects the type of port to be used. The Disable selection disables the port from the hotport process. The available selections are:

- **Twinax** (the default)
- **Coax**
- **Disable**

Note: Changing the Port Type in this menu option also changes the Port Type setting in the Coax Interface Menu.

Timeout

This is the value used by the printer to time out from the current port and check the other ports for data to print. When the printer has not received data from the host after the specified period of time, it needs to Timeout to service the other ports. The available selections are:

- **15 Seconds** (the default).
- **10 to 180 Seconds**.

Report Status

- **Disable** (the default). A fault on the printer is reported only if it occurs on the active port.
- **Enable**. The faults are reported even if the fault is not on the current active port.

Maximum Printable Width

Sets the maximum width of the printer when using a CT host interface.

- **13.2 Inches** (the default)
- **13.6 Inches**

Note: The 5250 interface menu and 3270 interface menu option for maximum printable width use the same internal variable. Setting this option in either menu will make it the current setting for the printer, independent of the interface used.

Although the LP+ emulation maintains width in characters, the maximum printable width in characters is controlled by the same internal variable that is set by the 5250 interface menu and 3270 interface menu option for maximum printable width option.

Compatibility Options Menu

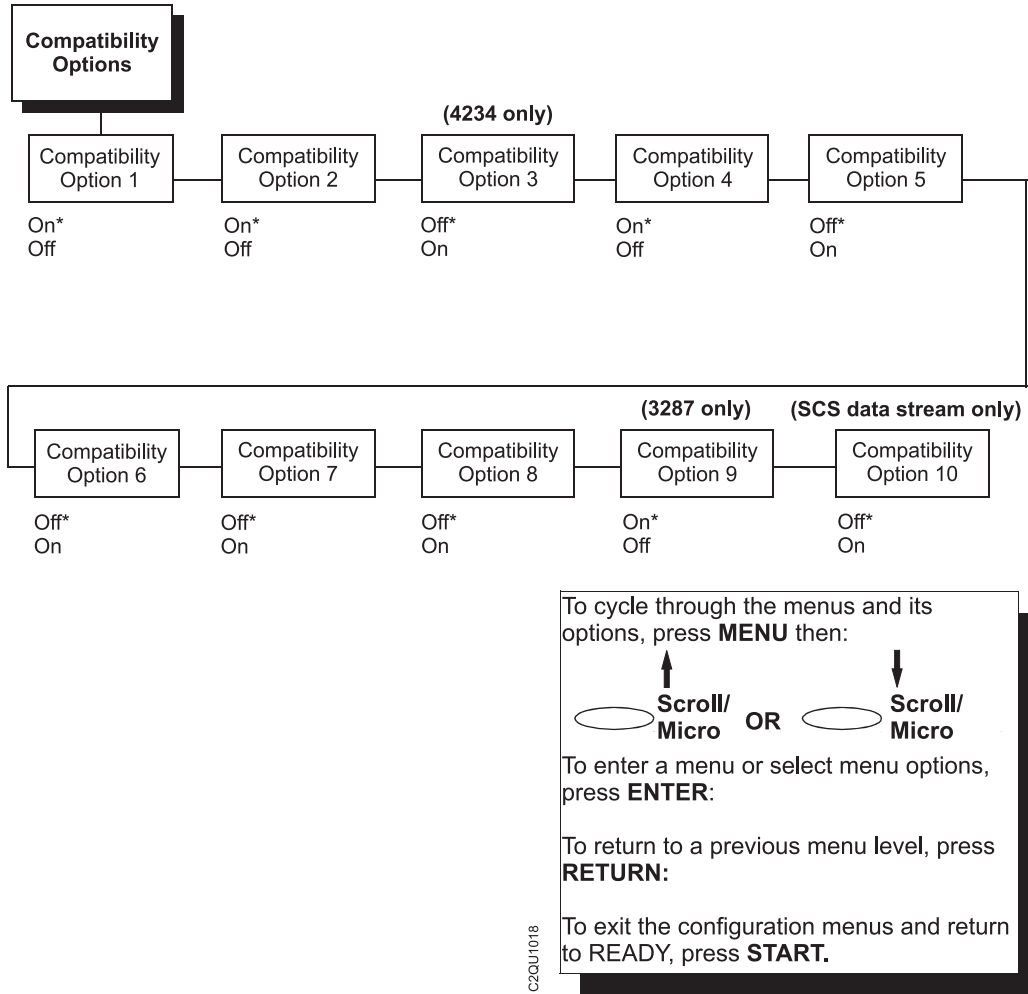

Figure 31. Compatibility Options Menu

Compatibility Option 1: Carriage Return at MPP+1

MPP is Maximum Print Position, which is also known as line length. OPTION 1 controls a carriage return at the end of a print line and at MPP+1.

- **ON** (the default). Produces a carriage return to the first print position of the next line.
- **OFF**. Produces a carriage return to the first print position of the current line.

Compatibility Option 2: New Line at MPP+1

NEW LINE AT MPP+1 controls how many lines are skipped when the carriage returns to a new line.

- **ON** (the default). Moves to the first print position two lines down from the current position.
- **OFF**. Moves to the first print position of the next print line.

Compatibility Option 3: Position After Form Feed (4234 only)

POSITION AFTER FORM FEED allows you to select the location of the print position after a form feed command is sent.

- **OFF** (the default). Sets the printer to print at position 2 of the first print line on the next form.
- **ON**. Sets the printer to print at print position 1 of the first print line on the next form.

Compatibility Option 4: Form Feed at End of Print Buffer

FORM FEED AT END OF PRINT BUFFER determines the print line position when a form feed command is the last code encountered in the print buffer.

- **ON** (the default). Moves to the first print position on the second line of the next form.
- **OFF**. Moves to the first print position on the first line of the next form.

Note: This option is ignored if Compatibility Option 7 is on.

If configured as a 3287, and a form feed occurs in the middle of a print buffer, the printer defaults to the first print position on the second line of the next form, regardless of the setting of this option.

Compatibility Option 5: Null Suppression

NULL SUPPRESSION will either treat nulls as blank spaces or ignore them. If nulls are ignored, the print position does not move.

- **OFF** (the default). Ignores nulls.
- **ON**. Treats nulls as blank spaces.

Compatibility Option 6: Form Feed Command Position

FORM FEED COMMAND POSITION determines if the position of a form feed command affects its execution.

- **OFF** (the default). Performs a form feed only if it occurs at the first print position in a line or at Maximum Print Position +1. (The Maximum Print Position is the line length.) A form feed command at any other position is recognized as a blank.
- **ON**. Allows the printer to perform a form feed command anywhere in the data stream.

Compatibility Option 7: Automatic Form Feed at End of Print Buffer

AUTOMATIC FORM FEED AT END OF PRINT BUFFER specifies whether or not to perform an automatic form feed at the end of a print buffer.

- **OFF** (the default). Performs an automatic new line command after completing a print buffer (unless a form feed, new line, or carriage return command was the last one executed). The printer is set to print at print position 1 of the next line.
- **ON**. Performs an automatic form feed after completing a print buffer (unless a form feed command was the last one in the buffer). The printer is set to print at print position 1 of the first line of the next form.

Compatibility Option 8: Automatic FF After Operator-Initiated Copy

This option determines the print position after an operator-initiated local copy (print screen function).

- **OFF** (the default). Performs an automatic new line command after completing a print buffer (unless a new line, form feed or carriage return command was the last one executed). The printer is set to print at print position 1 of the next line.
- **ON**. Performs an automatic form feed command unless a form feed was the last one executed. The printer is set to print at print position 1 of the first line on the next form.

**Compatibility Option 9:
CR, EM, and NL (3287 only)**

CR (Carriage Return), EM (Error Message), and NL (New Line) specify that the printer treat the CR, EM, and NL control codes either as spaces or as control codes.

- **ON** (the default). Treats the CR, EM and NL commands as control codes.
- **OFF**. Treats the CR, EM and NL commands as spaces.

**Compatibility Option 10:
Bottom Margin (SCS data stream only)**

Any bottom margin specified or implied by a host command will be overridden, causing the operator panel bottom margin value to be used.

- **OFF** (the default). Ignores the operator panel bottom margin value.
- **ON**. Forces the bottom margin to the value specified by the operator panel.

Note: If Bottom Margin is ON, the operator can enter a bottom margin; the top margin will be forced to zero. If it is OFF, the operator panel bottom margin is forced to zero.

Network Setup Menu

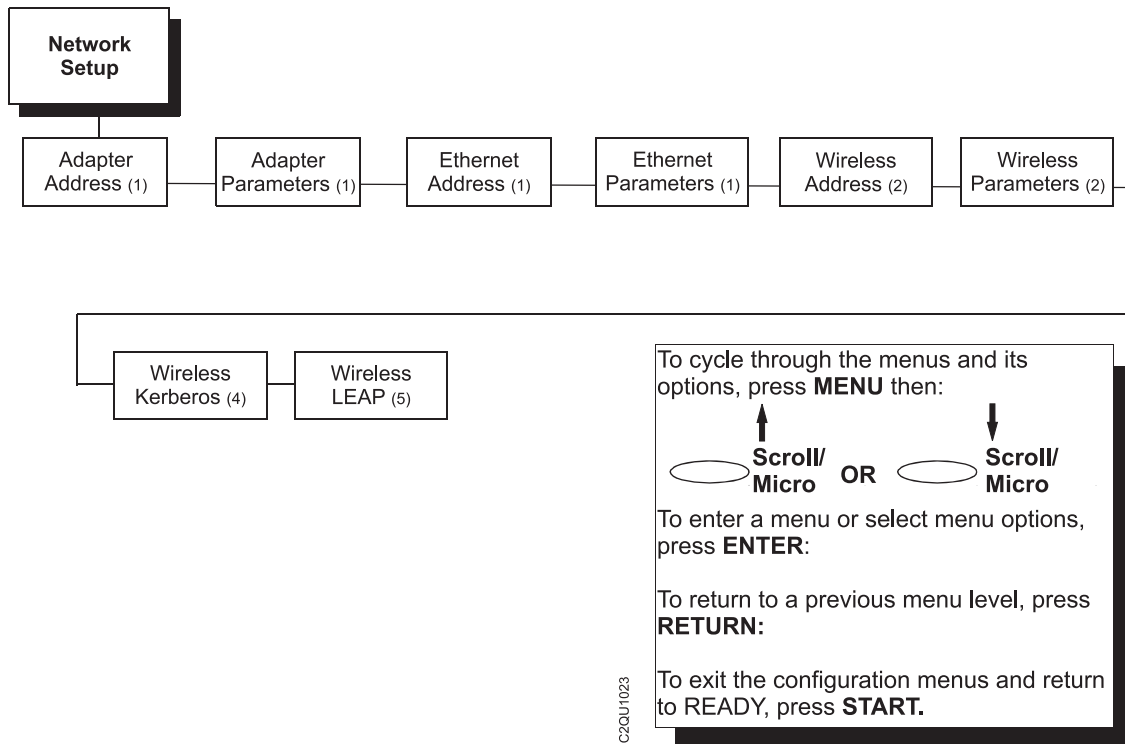

Notes:

1. Only if the Ethernet Adapter feature is installed.
2. Only if the Integrated Ethernet feature is installed.
3. Only if the Wireless Adapter feature is installed.
4. Only if RFID is installed.
5. Only if a Cisco radio card is installed.

Figure 32. Network Setup Menu

Adapter Address Submenu

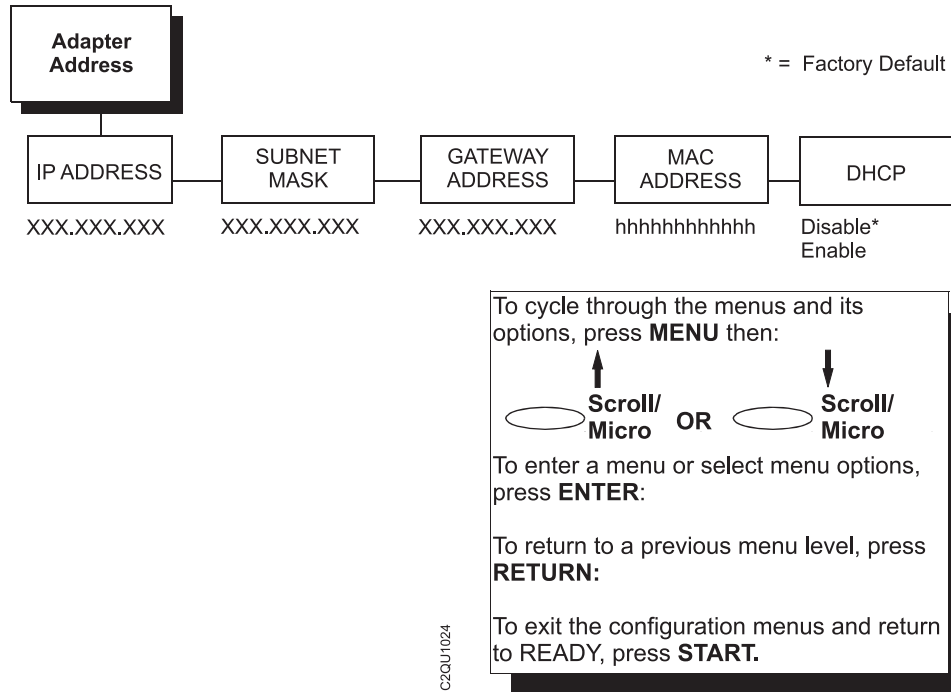

Figure 33. Adapter Address Submenu

IP Address

A numeric address such as 123.45.61.23 which identifies a printer or server in a LAN or WAN.

Subnet Mask

A binary value used to divide IP networks into smaller Subnetworks or Subnets. This mask is used to help determine whether IP packets need to be forwarded to the Subnets.

Gateway Address

A gateway address is the IP address of a hardware device (gateway) that translates data between two incompatible networks, which can include protocol translation.

MAC Address

This menu item is the Manufacturer's Assigned Number, and is unique for each printer. It is read-only.

DHCP

You can enable/disable the DHCP protocol using this option, but consult your administrator for the appropriate setting.

The options include:

- **Disable** (the default)
- **Enable**

Adapter Parameters Submenu

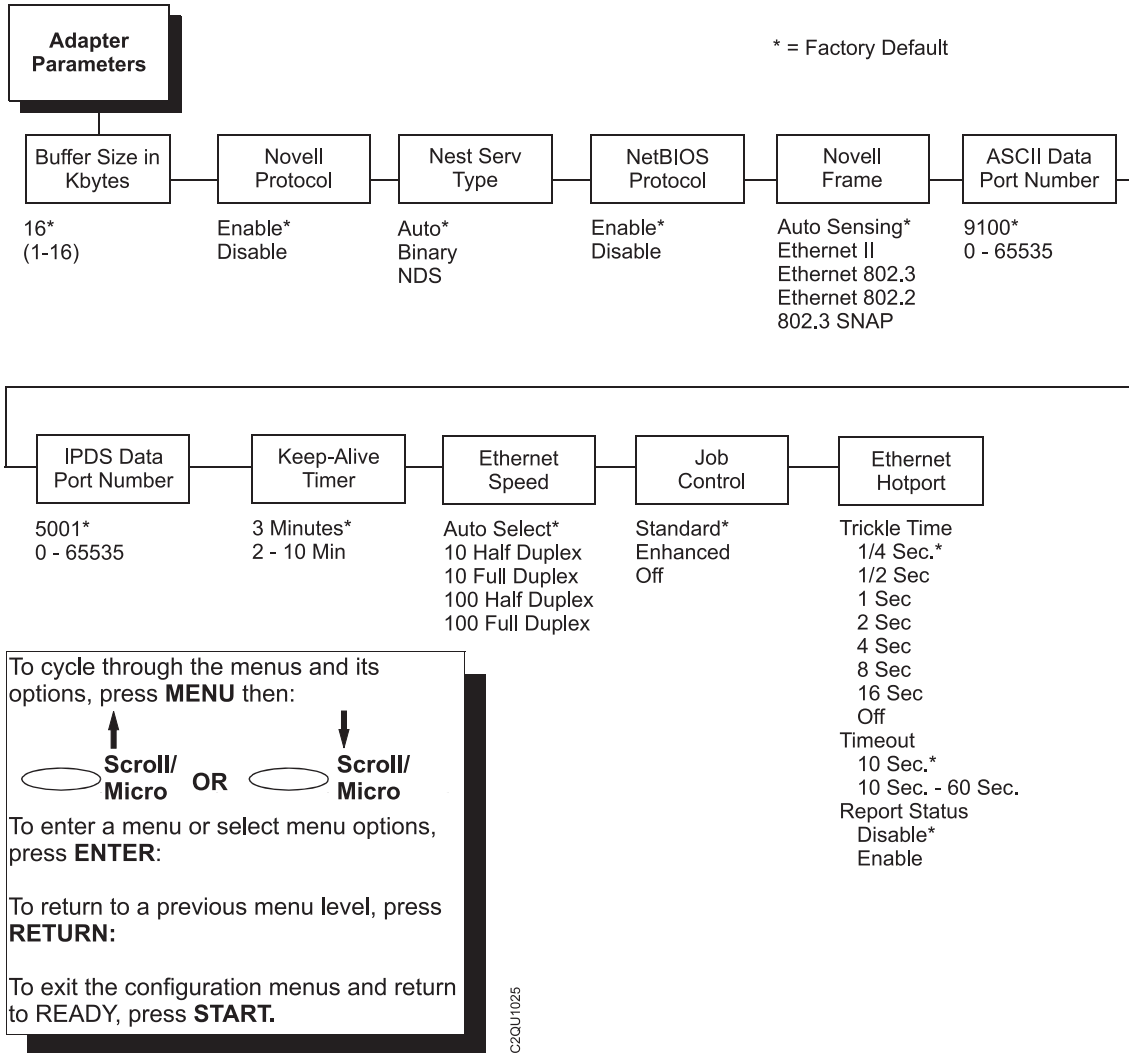

Figure 34. Adapter Parameters Submenu

Detailed information regarding the Ethernet IP Address, Gateway Address, Subset Mask, and MAC Address capabilities can be found in the *Ethernet Interface User's Manual*. Access to the parameters is through the operator panel.

Buffer Size in Kbytes

This parameter determines the size of the input buffer, in 1K increments. A selection of up to 16K is shown.

- **16K** (default)
- **1 - 16**
- **NDS**.

Novell Protocol

This option determines whether the Novell protocol will be available. The selections are as indicated below:

- **Enable** (default). Makes the Novell protocol available with the Ethernet installed.
- **Disable**. Makes the Novell protocol unavailable during printer operation.

Nest Serv Type

You can change the Nest Server using this option, but consult your administrator for the appropriate setting.

The options are Auto (factory default), Bindery, and NDS.

NetBIOS Protocol

This option determines whether the NetBIOS protocol will be available. The selections are as indicated below:

- **Enable** (the default). Makes the NetBIOS protocol available with the Ethernet installed.
- **Disable**. Makes the NetBIOS protocol unavailable during printer operation.

Novell Frame

This selection determines which framing schemes will be used in processing Novell signals.

- **Auto Sensing** (default)
- **Ethernet II**
- **Ethernet 802.3**
- **Ethernet 802.2**
- **802.2 Snap**

ASCII Data Port Number

This option sets the port number for ASCII print jobs. The data port number needs to match your host system setting.

- **9100** (default)
- **0 - 65535**

IPDS Data Port Number

This option allows you to set the port number for IPDS print jobs. The port number needs to match your host system.

- **5001** (the default)
- **0 - 65535**

Keep-Alive Timer

This is the time that the Keep Alive Timer will run. With the Keep Alive Timer on, the TCP connection will stay connected even after the print job has terminated.

- **3 Minutes** (default)
- **2 - 10 Minutes**

Ethernet Speed

The Ethernet Speed menu allows compatibility with different systems and networks. The factory default is Auto Select.

- **Auto Select** (the default). This setting tells the 10/100Base-T NIC to perform an auto detection scheme and configure itself to be 10 Half Duplex, 10 Full Duplex, 100 Half Duplex, or 100 Full Duplex.
- **10 Half Duplex**. This setting tells the 100 Base-T NIC to communicate at 10 Megabits per second using half duplex.
- **10 Full Duplex**. This setting tells the 100 Base-T NIC to communicate at 10 Megabits per second using full duplex.
- **100 Half Duplex**. This setting tells the 100 Base-T NIC to communicate at 100 Megabits per second using half duplex.
- **100 Full Duplex**. This setting tells the 100 Base-T NIC to communicate at 100 Megabits per second using full duplex.

Job Control

The job control mode has three options:

- **Standard** (default). The NIC waits for the printer to finish receiving the current job before sending another job. The status line shows “done” when the job is completely received by the NIC. This is the default.
- **Enhanced**. The NIC waits for the printer to finish receiving the current job before sending another job. The status line shows “done” when the job is fully printed.
- **Off**. No job synchronization between the NIC and the printer.

Ethernet Hotport

Gives the printer the ability to handle multiple data streams simultaneously. It allows the printer to service hosts attached to the serial, Ethernet, and either the Coax or Twinax ports as if they were the only interface connected.

Trickle Time: This functionality prevents an attached host from timing out. In order to support this feature, the port has to be able to accept data from the host and store it for future use. The selected value is the time that the printer waits before getting the next byte of data from the host. Set the value to be less than the host timeout value. If the value is too much shorter, the printer fills up its buffer too fast. This function is not applicable for C/T Hotport.

- $\frac{1}{4}$ Sec (the default)
- $\frac{1}{2}$ Sec
- 1 Sec
- 2 Sec
- 4 Sec
- 8 Sec
- 16 Sec
- OFF

Timeout: This is the value used by the printer to time out from the current port and check the other ports for data to print. When the printer has not received data from the host after a certain period of time, it needs to Timeout in order to service the other ports.

- 10 Sec (the default)
- 10 Sec - 60 Sec

Report Status: When this option is enabled, faults are reported even if the fault is not on the current active port. If the option is disabled, a fault on the printer is reported only if it occurs on the active port.

- **Disable** (the default)
- **Enable.**

Ethernet Address Submenu

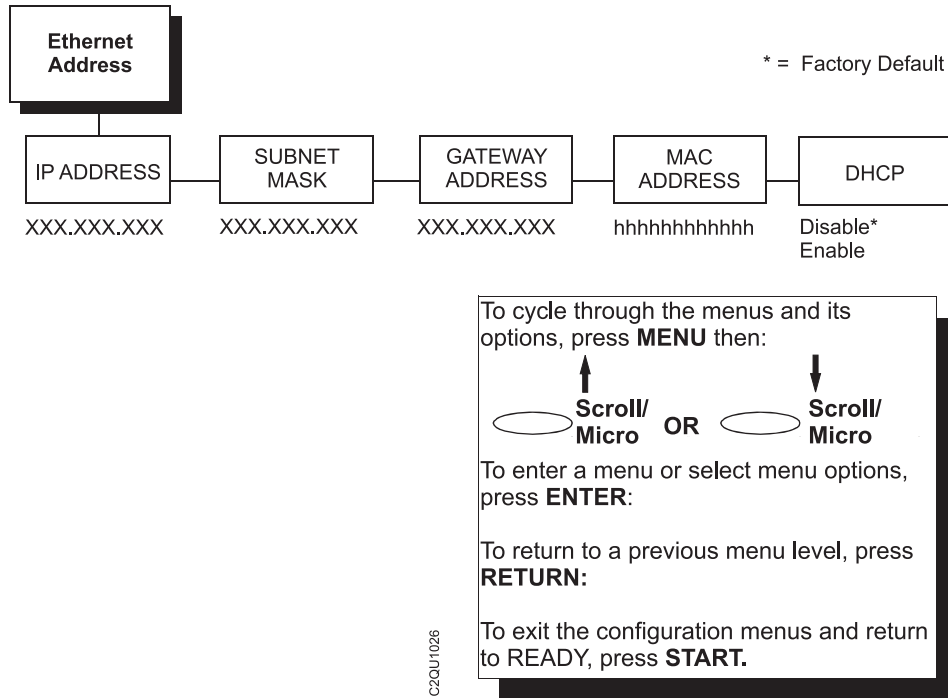

Figure 35. Ethernet Address Submenu

IP Address

A numeric address such as 123.45.61.23 which identifies a printer or server in a LAN or WAN.

Subnet Mask

A binary value used to divide IP networks into smaller Subnetworks or Subnets. This mask is used to help determine whether IP packets need to be forwarded to other Subnets.

Gateway Address

A gateway address is the IP address of a hardware device (gateway) that translates data between two incompatible networks, which can include protocol translation.

MAC Address

This menu item is the Manufacturer's Assigned Number, and is unique for each printer. It is read-only.

DHCP

You can enable/disable the DHCP protocol using this option, but consult your administrator for the appropriate setting. The options are:

- **Disable** (the default)
- **Enable**

Ethernet Parameters Submenu

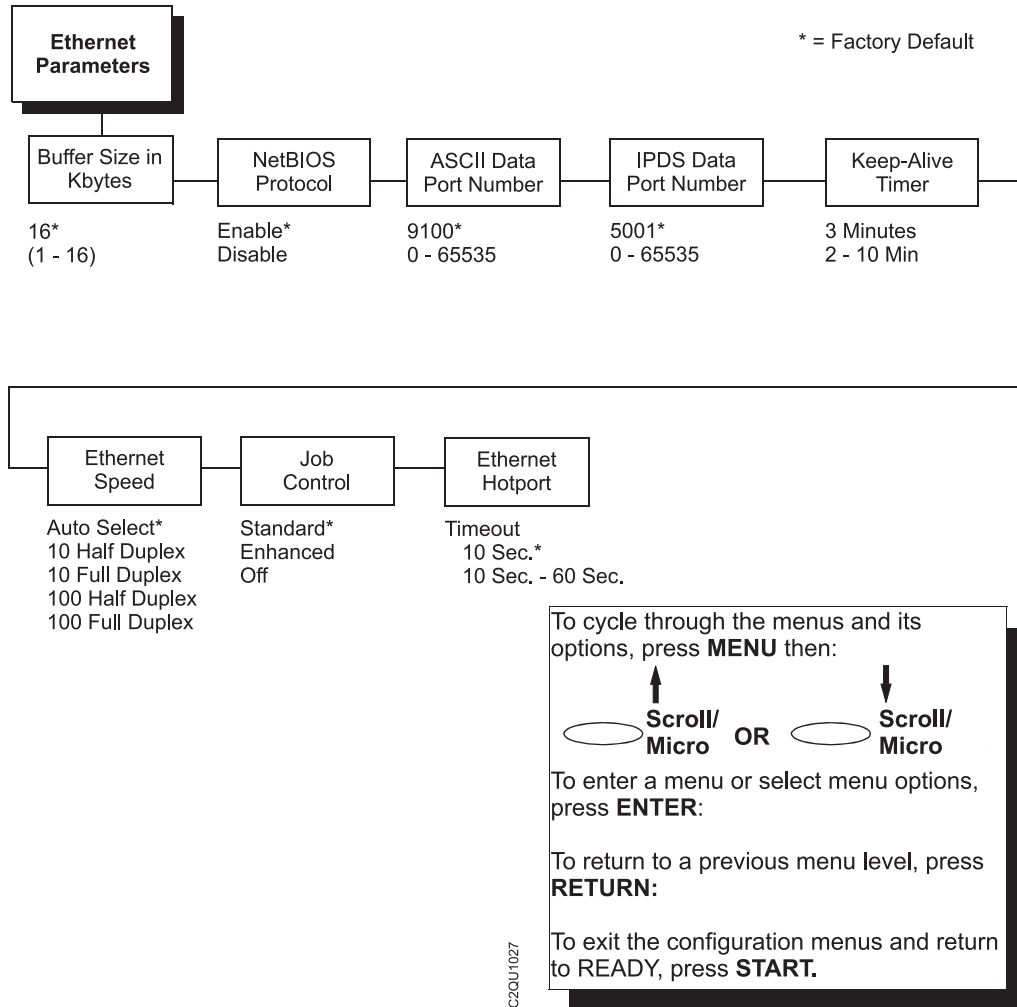

Figure 36. Ethernet Parameters Submenu

Detailed information regarding the Ethernet IP Address, Gateway Address, Subnet Mask, and MAC Address capabilities can be found in the *Ethernet Interface User's Manual*. Access to the parameters is through the operator panel.

Buffer Size in Kbytes

This parameter determines the size of the input buffer, in 1K increments. A selection of up to 16K is shown.

- **16K** (the default)
- **1 - 16**
- **NDS**.

NetBIOS Protocol

This option determines whether the NetBIOS protocol will be available. The selections are as indicated below:

- **Enable** (the default). Makes the NetBIOS protocol available with the integrated Ethernet installed.
- **Disable**. Makes the NetBIOS protocol unavailable during printer operation.

ASCII Data Port Number

This option sets the port number for ASCII print jobs. The data port number needs to match your host system setting.

- **9100** (the default)
- **0 - 65535**

IPDS Data Port Number

This option allows you to set the port number for IPDS print jobs. The port number needs to match your host system.

- **5001** (the default)
- **0 - 65535**

Keep Alive Timer

This is the time that the Keep Alive Timer will run. With the Keep Alive Timer on, the tcp connection will stay connected even after the print job has terminated.

- **3 Min** (the default)
- **2 — 10 Min**

Ethernet Speed

The Ethernet Speed allows compatibility with different systems and networks. The factory default is Auto Select.

- **Auto Select** (the default). This setting tells the 10/100Base-T NIC to perform an auto detection scheme and configure itself to be 10 Half Duplex, 10 Full Duplex, 100 Half Duplex, or 100 Full Duplex.
- **10 Half Duplex**. This setting tells the 100 Base-T NIC to communicate at 10 Megabits per second using half duplex.
- **10 Full Duplex**. This setting tells the 100 Base-T NIC to communicate at 10 Megabits per second using full duplex.
- **100 Half Duplex**. This setting tells the 100 Base-T NIC to communicate at 100 Megabits per second using half duplex.
- **100 Full Duplex**. This setting tells the 100 Base-T NIC to communicate at 100 Megabits per second using full duplex.

Job Control

The job control mode has three options:

- **Standard** (the default). The NIC waits for the printer to finish receiving the current job before sending another job. The status line shows “done” when the job is completely received by the NIC. This is default.
- **Enhanced**. The NIC waits for the printer to finish receiving the current job before sending another job. The status line shows “done” when the job is fully printed.
- **Off**. No job synchronization between the NIC and the printer.

Ethernet Hotport

Gives the printer the ability to handle multiple data streams simultaneously. It allows the printer to service hosts attached to the serial, Ethernet, and either the Coax or Twinax ports as if they were the only interface connected.

Timeout: This is the value used by the printer to time out from the current port and check the other ports for data to print. When the printer has not received data from the host after a certain period of time, it needs to Timeout in order to service the other ports.

- **10 Sec** (the default)
- **10 Sec- 60 Sec**

Wireless Address Menu

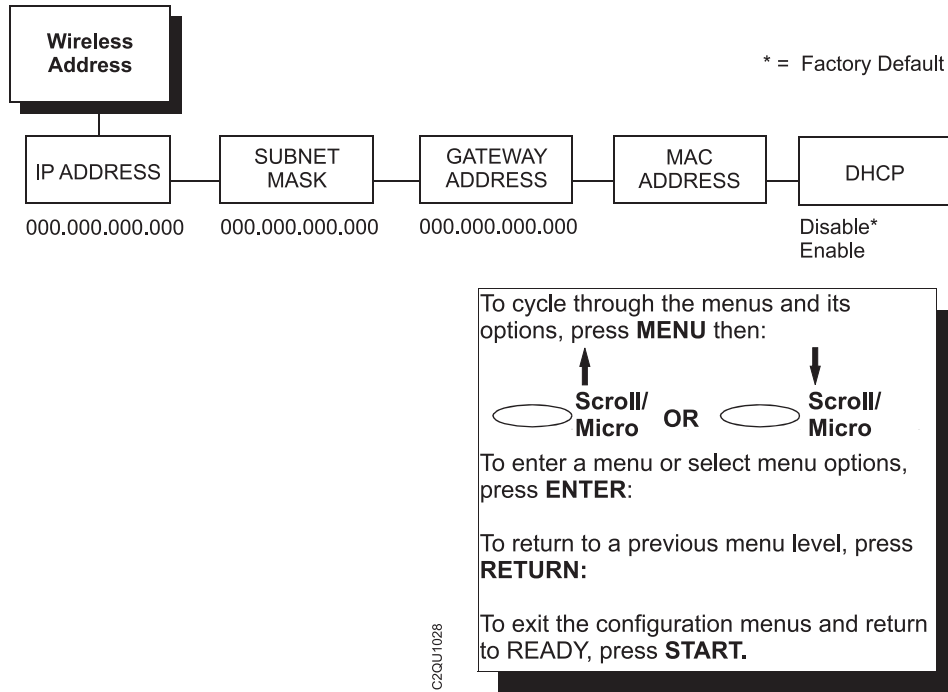

Figure 37. Wireless Address Menu

IP Address

A numeric address such as 123.45.61.23 which identifies a printer or server in a LAN or WAN.

Subnet Mask

A binary value used to divide IP networks into smaller Subnetworks or Subnets. This mask is used to help determine whether IP packets need to be forwarded to other Subnets.

Gateway Address

A gateway address is the IP address of a hardware device (gateway) that translates data between two incompatible networks, which can include protocol translation.

MAC Address

This menu item is the Manufacturer's Assigned Number, and is unique for each printer. It is read-only.

DHCP

You can enable/disable the DHCP protocol using this option, but consult your administrator for the appropriate setting. The options include:

- **Disable** (default)
- **Enable**.

Wireless Parameters Menu

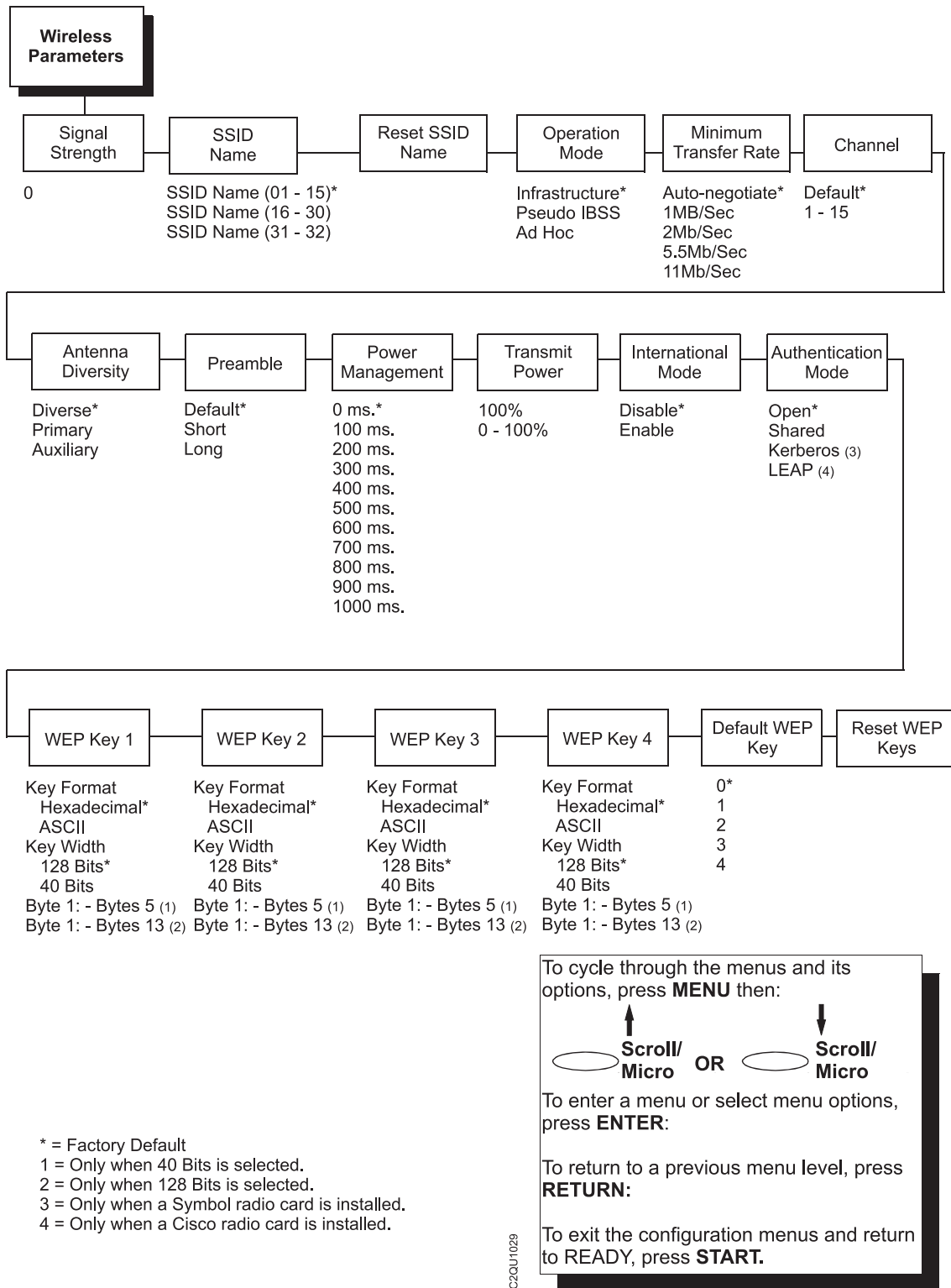

Figure 38. Wireless Parameters Menu

Signal Strength

This menu displays the strength of the wireless signal.

Note: This is a display value only and cannot be changed.

SSID Name

A 1 - 32 character, case sensitive string that identifies the group the printer talks to.

Note: The SSID name may be edited in three parts (1 - 15), (16 - 30), and (31 - 31).

For each part of the SSID name, press the LINE FEED or FORM FEED keys to cycle through the values available for that character at the cursor location. Press the SCROLL UP key to move to the next character to be modified. Press the SCROLL DOWN key to go back to a character you have already modified.

Continue until you have entered the name you want to give to this SSID name, then press ENTER to save. The name you entered will now represent this SSID name on the printer's front panel. To exit this menu without saving, press any key other than the ENTER key. The SSID name will revert to the last saved value.

Reset SSID Name

Allows you to reset the SSID name.

Operation Mode

Allows you to select the way the Wireless option communicates:

- **Infrastructure** (default). The Wireless option must go through a server.
- **Pseudo IBSS**. Proprietary, peer-to-peer communication (without a server). The two peers must be specific to one manufacturer.
- **Ad Hoc**. Standard, peer-to-peer communication (without a server). The two peers can be from different manufacturers.

Minimum Transfer Rate

Allows you to set the minimum speed at which the Wireless Option will accept a connection (in million bits per second). The options are:

- **Auto-negotiate** (default)
- **1Mb/sec.**
- **2Mb/sec.**
- **5.5Mb/sec**
- **11Mb/sec**

Channel

Allows you to select the RF channel. The options are Default (the factory default) and 1-15.

Antenna Diversity

The type of antenna used:

- **Diverse** (default). Select when you want to use the antenna with the best reception.
- **Primary**. Select when you want to use the Primary antenna on the server.
- **Auxiliary**. Select when you want to use the Auxiliary antenna on the server.

Preamble

The length of the preamble in transmit packets.

- **Default**. The Wireless option automatically determines the length.
- **Short**. For newer printers which can handle higher transfer rate speeds.
- **Long**. For older printers which cannot handle higher transfer rate speeds.

Power Management

This allows you to set power-save mode and sleep time. A value specifying the sleep time in milliseconds will be provided. If set to zero, power-save mode will be disabled. The range includes:

- **0 ms.** (default)
- **100 ms. -1000 ms.**

Transmit Power

The power level as a percentage of full power (0 — 100%).

International Mode

When enabled, the Wireless option adapts to international frequency requirements in Europe. The options include:

- **Disable** (default)
- **Enable**.

Authentication Method

This feature allows the user to select the authentication method used for the wireless network interface.

- **Open** (the default). Selects open authentication.
- **Shared**. Selects shared key authentication.
- **Kerberos**. Selects Kerberos authentication (for use when a Symbol RF card is installed).
- **LEAP**. Selects LEAP authentication (for use with a Cisco RF card installed).

Default WEP Key

This feature enables you to encrypt (scramble) information for security purposes. With this feature, you can set up to four encryption keys, in either ASCII or hexadecimal format, and in either 40 or 128 bits. (The more bits you choose, the more difficult it will be to decode the information.)

Note: None of the WEP Key Configuration menus display on the configuration printout.

WEP Key Format

Allows you to format the WEP keys in ASCII or hexadecimal code. The default is hexadecimal.

WEP Key Width

This is the encryption strength. The options are 40 Bits and 128 Bits; 40 Bits are weaker and 128 Bits are stronger.

Note: If you select 40 Bits, the WEP key BYTE6 through WEP Key BYTE13 menus will not display.

The default is 128 Bits.

WEP Key BYTE1 through BYTE13

These are the individual characters of the encryption key.

Reset WEP Keys

Allows you to reset all four WEP keys (WEP Key 1 through WEP Key 4) at one time.

Wireless Kerberos

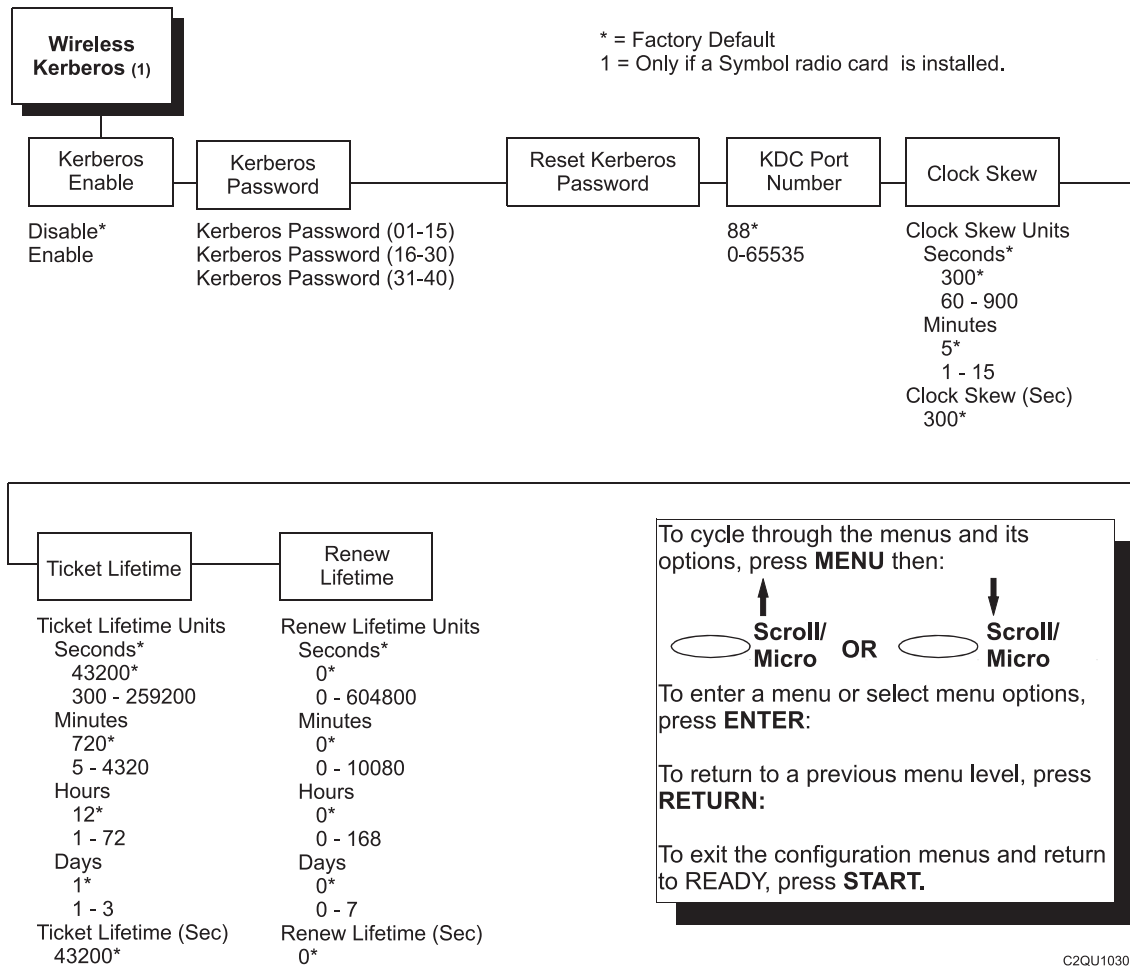

Figure 39. Wireless Kerberos Menu

Kerberos Enable

- **Disable** (the default). Disables Kerberos authentication in the wireless network interface.
- **Enable**. Enables Kerberos authentication in the wireless network interface.

Kerberos Password

- **Kerberos Password (01 - 15).** The first 15 characters of the Kerberos password (maximum number of characters is 40).
- **Kerberos Password (16 - 30).** Characters 16 to 30 of the Kerberos password (maximum number of characters is 40).
- **Kerberos Password (31 - 40).** Characters 31 to 40 of the Kerberos password (maximum number of characters is 40).

Reset Kerberos Password

Resets the Kerberos password to an empty string.

KDC Port Number

KDC (Key Distribution Center) port number is the 2-byte UDP/TCP port used for Kerberos Communication.

The range is 0-65535, and the factory default is 88.

Clock Skew

Sets the maximum allowable amount of time in seconds or minutes that Kerberos authentication will tolerate before assuming that a Kerberos message is valid. The range for Seconds is 60-900, and the default is 300. The range for Minutes is 1-15, and the default is 5.

Ticket Lifetime

Sets the maximum allowable amount of time in Seconds, Minutes, Hours, or Days that a ticket obtained from the Kerberos server is valid before getting a new one.

- **Seconds.** The range is 300-259200, and the default is 43200.
- **Minutes.** The range is 5-4320, and the default is 720.
- **Hours.** The range is 1-72, and the default is 12.
- **Days.** The range is 1-3, and the default is 1.
- **Ticket Lifetime (Sec).** The ticket lifetime unit in seconds. The default is 43200.

Renew Lifetime

Sets the maximum allowable amount of time in Seconds, Minutes, Hours, or Days before warning that a new Kerberos password is needed.

- **Seconds.** The range is 0-604800, and the default is 0.
- **Minutes.** The range is 0-10080, and the default is 0.
- **Hours.** The range is 1-168, and the default is 0.
- **Days.** The range is 0-7, and the default is 0.
- **Renew Lifetime Units.** Renew lifetime unit in seconds. The range is 5-604800, and the default is 0.

Wireless LEAP

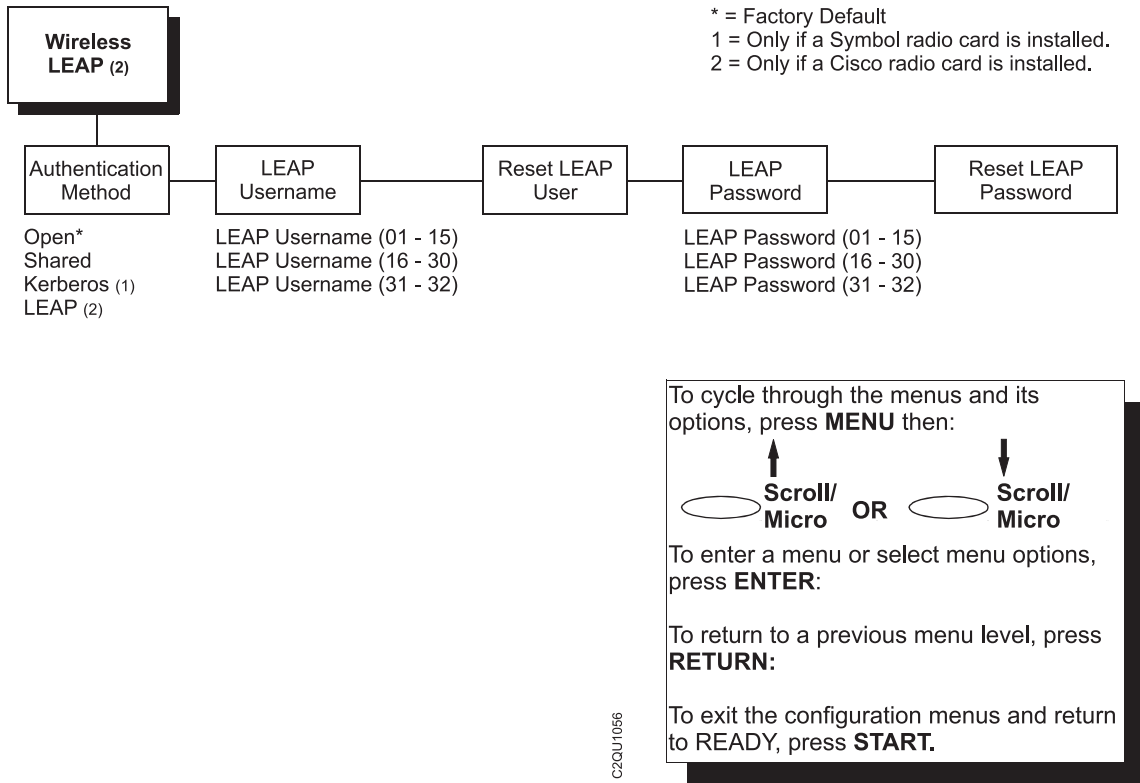

Figure 40. Wireless LEAP Menu

Authentication Method

This feature allows the user to select the authentication method used for the wireless network interface.

- **Open** (the default). Selects open authentication.
- **Shared**. Selects shared key authentication.
- **Kerberos**. Selects Kerberos authentication (for use when a Symbol RF card is installed).
- **LEAP**. Selects LEAP authentication (for use with a Cisco RF card installed).

LEAP Username

- **LEAP Username (01 - 15).** The first 15 characters of the LEAP user name (maximum number of characters is 32).
- **LEAP Username (16 - 30).** Characters 16 to 30 of the LEAP user name (maximum number of characters is 32).
- **LEAP Username (31 - 32).** Characters 31 to 32 of the LEAP user name (maximum number of characters is 32).

Reset LEAP User

Resets the LEAP user name to an empty string.

LEAP Password

- **LEAP Password (01 - 15).** The first 15 characters of the LEAP password (maximum number of characters is 32).
- **LEAP Password (16 - 30).** Characters 16 to 30 of the LEAP password (maximum number of characters is 32).
- **LEAP Password (31 - 32).** Characters 31 to 32 of the LEAP password (maximum number of characters is 32).

Reset LEAP Password

Resets the LEAP password to an empty string.

Parallel Interface Menu

Refer to Chapter 5 for more information about printer interfaces.

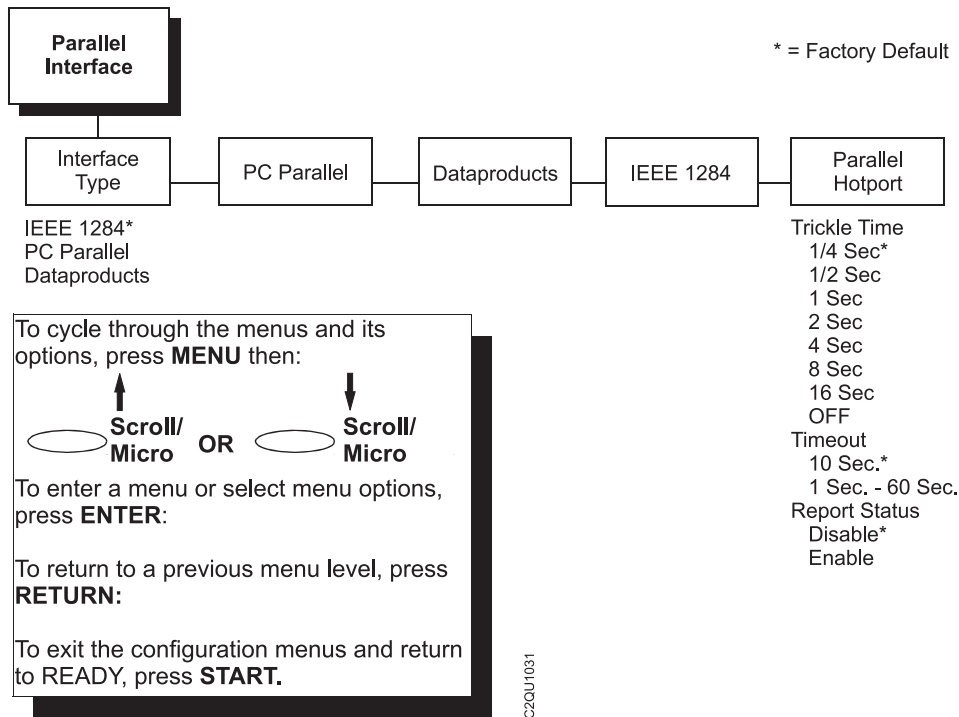

Figure 41. Parallel Interface Menu

Interface Type

The INTERFACE TYPE parameter selects which electrical interface will drive the parallel port interface, as follows:

- IEEE 1284 (the default)
- PC Parallel
- Dataproducts

PC Parallel

See "PC Parallel Menu" on page 119.

Dataproducts

See "Dataproducts Menu" on page 122.

IEEE 1284

See "IEEE 1284" on page 125.

Parallel Hotport

Gives the printer the ability to handle multiple data streams simultaneously. It allows the printer to service hosts attached to the serial, parallel, and either the Coax or Twinax ports as if they were the only interface connected.

Trickle Time

This functionality prevents an attached host from timing out. In order to support this feature, the port has to be able to accept data from the host and store it for future use. The selected value is the time that the printer waits before getting the next byte of data from the host. Set the value to be less than the host time out value. If the value is too much shorter, the printer fills up its buffer too fast. This function is not applicable for C/T hotport.

- $\frac{1}{4}$ Sec (the default)
- $\frac{1}{2}$ Sec
- 1 Sec
- 2 Sec
- 4 Sec
- 8 Sec
- 16 Sec
- OFF

Timeout

This is the value used by the printer to time out from the current port and check the other ports for data to print. When the printer has not received data from the host after a certain period of time, it needs to Timeout in order to service the other ports.

- 10 Sec (the default)
- 10 Sec - 60 Sec

Report Status

When this option is enabled, faults are reported even if the fault is not on the current active port. If the option is disabled, a fault on the printer is reported only if it occurs on the active port.

- **Disable** (the default)
- **Enable**

PC Parallel Menu

The PC PARALLEL menu configures the electrical signals to operate as a PC Parallel printer.

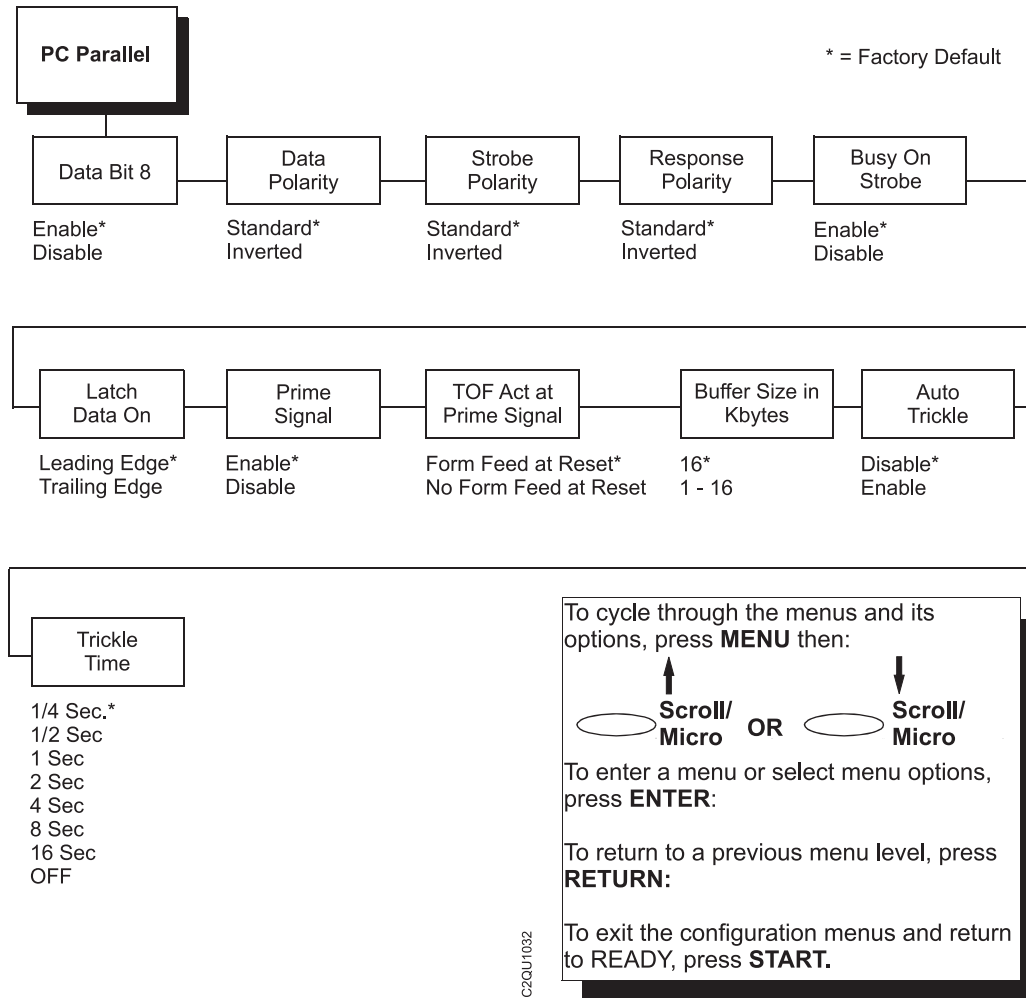

Figure 42. PC Parallel Menu

Data Bit 8

The DATA BIT 8 parameter allows access to the extended ASCII character set. This parameter is enabled by default. When this parameter is disabled, the printer interprets bit 8 of each incoming data character as a zero, regardless of its actual setting.

The extended ASCII character set is shown in the *InfoPrint 6500 ASCII Programmer's Reference Manual*.

- **Enable** (the default)
- **Disable**

Data Polarity

The DATA POLARITY parameter must be set to match the data polarity of your host computer.

- **Standard** (the default). Does not expect the host computer to invert the data.
- **Inverted**. Expects the host computer to invert the data received on the data lines. Ones become zeros, and vice-versa.

Strobe Polarity

The STROBE POLARITY must be set to match the data strobe polarity of your host computer. When the host computer sends a data strobe signal to the printer, this enables the printer to read the data bus.

- **Standard** (the default). Does not expect the data strobe signal to be inverted.
- **Inverted**. Expects the host computer to invert the data strobe signal.

Response Polarity

The RESPONSE POLARITY parameter must be set to match the response polarity of your host computer.

- **Standard** (the default). Does not invert the response signal.
- **Inverted**. Inverts the response signal sent to the host computer.

Busy on Strobe

BUSY ON STROBE determines when the Busy signal is asserted.

- **Enable** (the default). Asserts a busy signal after each character is received.
- **Disable**. Asserts a busy signal only when the print buffers are full.

Latch Data On

The LATCH DATA ON parameter specifies whether the data is read on the leading or trailing edge of the data strobe signal.

- **Leading Edge** (the default)
- **Trailing Edge**

Prime Signal

- **Enable** (the default). When set and the host asserts the PRIME SIGNAL, the parallel port will perform a warm start.
- **Disable**. The parallel port will not perform a warm start when the host asserts the PRIME SIGNAL.

TOF Act at Prime Signal

TOF (Top-of-Form) ACTION AT PRIME SIGNAL determines whether or not a form feed is performed before a warm start when the prime signal is asserted from the host. This setting is only used if PRIME SIGNAL parameter is enabled.

- **Form Feed at Reset** (the default)
- **No Form Feed at Reset**

Buffer Size in Kbytes

This parameter determines the size of the input buffer, in 1K increments.

- **16K** (the default)
- **1 - 16K**

Auto Trickle

Auto Trickle is used to prevent a host computer from timing out because the parallel interface was busy for too long. When Auto Trickle is enable and the printer's buffers are almost full, the printer will begin to trickle data in (at the rate set in the Trickle Time menu) until the buffers start to empty out. If the value is too short, the printer fills up its buffer too fast.

Trickle Time

The functionality prevents an attached host from timing out. To support his feature, the port has to be able to accept data from the host and store it for future use. The selected value is the time that the printer waits before getting the next byte of data from the host. Set the value to be less than the host time-out value. If the value is too much shorter, the printer fills up its buffer too fast.

- **¼ Sec** (the default)
- **½ Sec**
- **1 Sec**
- **2 Sec**
- **4 Sec**
- **8 Sec**
- **16 Sec**
- **OFF**

Dataproducts Menu

The Dataproducts parallel interface is configured using the following configuration options.

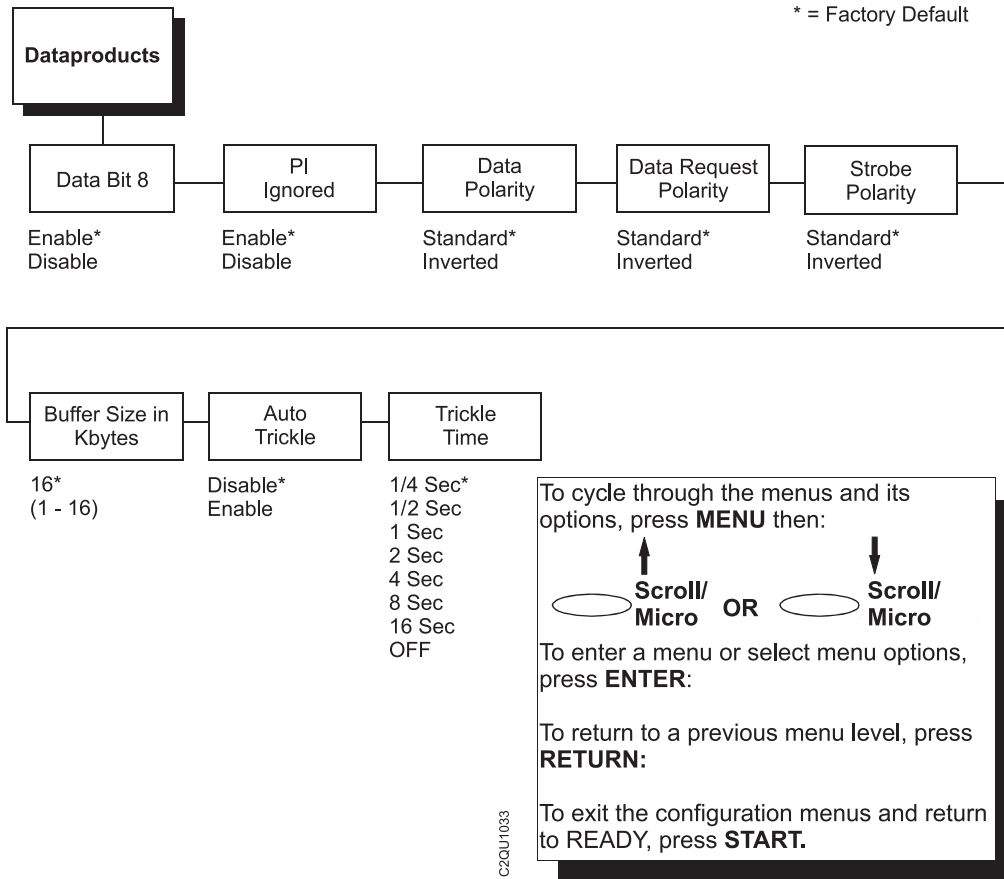

Figure 43. Dataproducts Menu

Data Bit 8

The DATA BIT 8 parameter allows access to the extended ASCII character set. This parameter is enabled by default. When this parameter is disabled, the printer interprets bit 8 of each incoming data character as a zero, regardless of its actual setting.

- **Enable** (the default)
- **Disable**

PI Ignored

The PI (Paper Instruction) signal is used to control vertical paper motion.

- **Enable** (the default). Ignores the PI signal and treats the data as characters or control codes.
- **Disable**. Causes the printer to interpret the eight data lines as VFU commands when the PI signal is true.

Data Polarity

The DATA POLARITY parameter must be set to match the data polarity of your host computer.

- **Standard** (the default). Does not expect the host computer to invert the data.
- **Inverted**. Expects the host computer to invert the data received on the data lines. Ones become zeros, and vice-versa.

Data Request Polarity

The DATA REQUEST POLARITY parameter must be set to match the data request polarity of your host computer.

- **Standard** (the default). Does not invert the request signal.
- **Inverted**. Inverts the request signal sent to the host computer.

Strobe Polarity

The STROBE POLARITY must be set to match the data strobe polarity of your host computer. When the host computer sends a data strobe signal to the printer, this enables the printer to read the data bus.

- **Standard** (the default). Does not expect the data strobe signal to be inverted.
- **Inverted**. Expects the host computer to invert the data strobe signal.

Buffer Size in Kbytes

This parameter determines the size of the input buffer, in 1K increments. Up to 16K are available.

- **16** (the default)
- **1 - 16**

Auto Trickle

Auto Trickle is used to prevent a host computer from timing out because the parallel interface was busy for too long. When Auto Trickle is enable and the printer's buffers are almost full, the printer will begin to trickle data in (at the rate set in the Trickle Time menu) until the buffers start to empty out.

Trickle Time

The functionality prevents an attached host from timing out. To support his feature, the port has to be able to accept data from the host and store it for future use. The selected value is the time that the printer waits before getting the next byte of data from the host. Set the value to be less than the host time-out value. If the value is too much shorter, the printer fills up its buffer too fast.

- $\frac{1}{4}$ Sec (the default)
- $\frac{1}{2}$ Sec
- 1 Sec
- 2 Sec
- 4 Sec
- 8 Sec
- 16 Sec
- OFF

IEEE 1284

The IEEE 1284 interface is configured using the following configuration options.

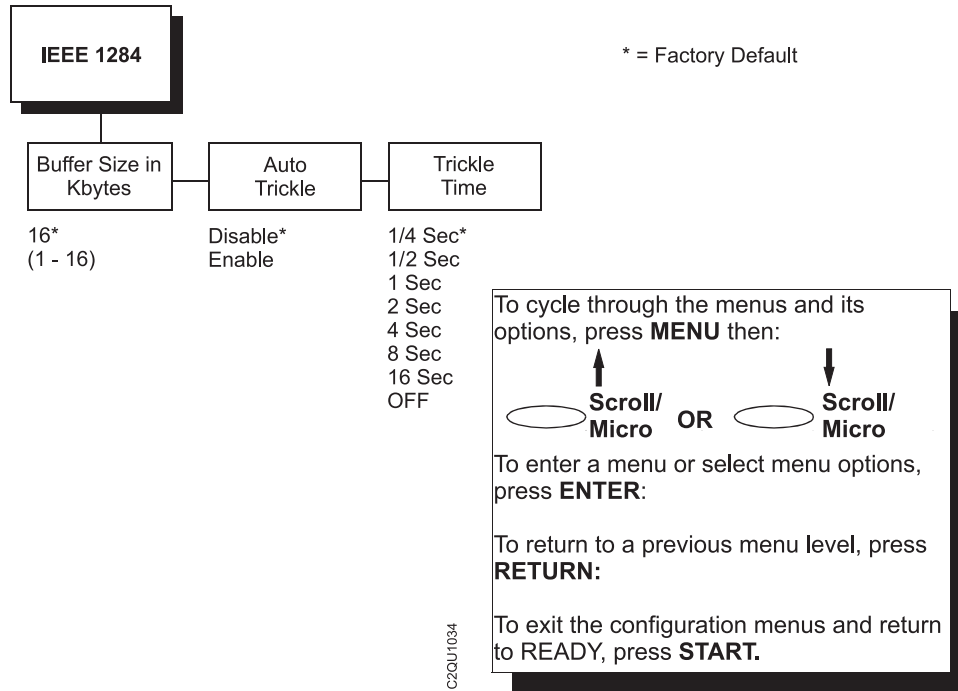

Figure 44. IEEE 1284 Menu

Buffer Size in Kbytes

This parameter determines the size of the input buffer, in 1K increments. Up to 16K are available.

- 16 (the default)
- 1 - 16

Auto Trickle

Auto Trickle is used to prevent a host computer from timing out because the parallel interface was busy for too long. When Auto Trickle is enable and the printer's buffers are almost full, the printer will begin to trickle data in (at the rate set in the Trickle Time menu) until the buffers start to empty out.

Trickle Time

The functionality prevents an attached host from timing out. To support this feature, the port has to be able to accept data from the host and store it for future use. The selected value is the time that the printer waits before getting the next byte of data from the host. Set the value to be less than the host time-out value. If the value is too much shorter, the printer fills up its buffer too fast.

- $\frac{1}{4}$ Sec (the default)
- $\frac{1}{2}$ Sec
- 1 Sec
- 2 Sec
- 4 Sec
- 8 Sec
- 16 Sec
- OFF

Serial Interface Menu

IMPORTANT: The serial parameters in the printer must be set to match the serial interface in the host computer (at the other end of the printer data cable). Otherwise, the printer may not operate correctly, and data characters from the computer may not print or may appear as “garbled” text.

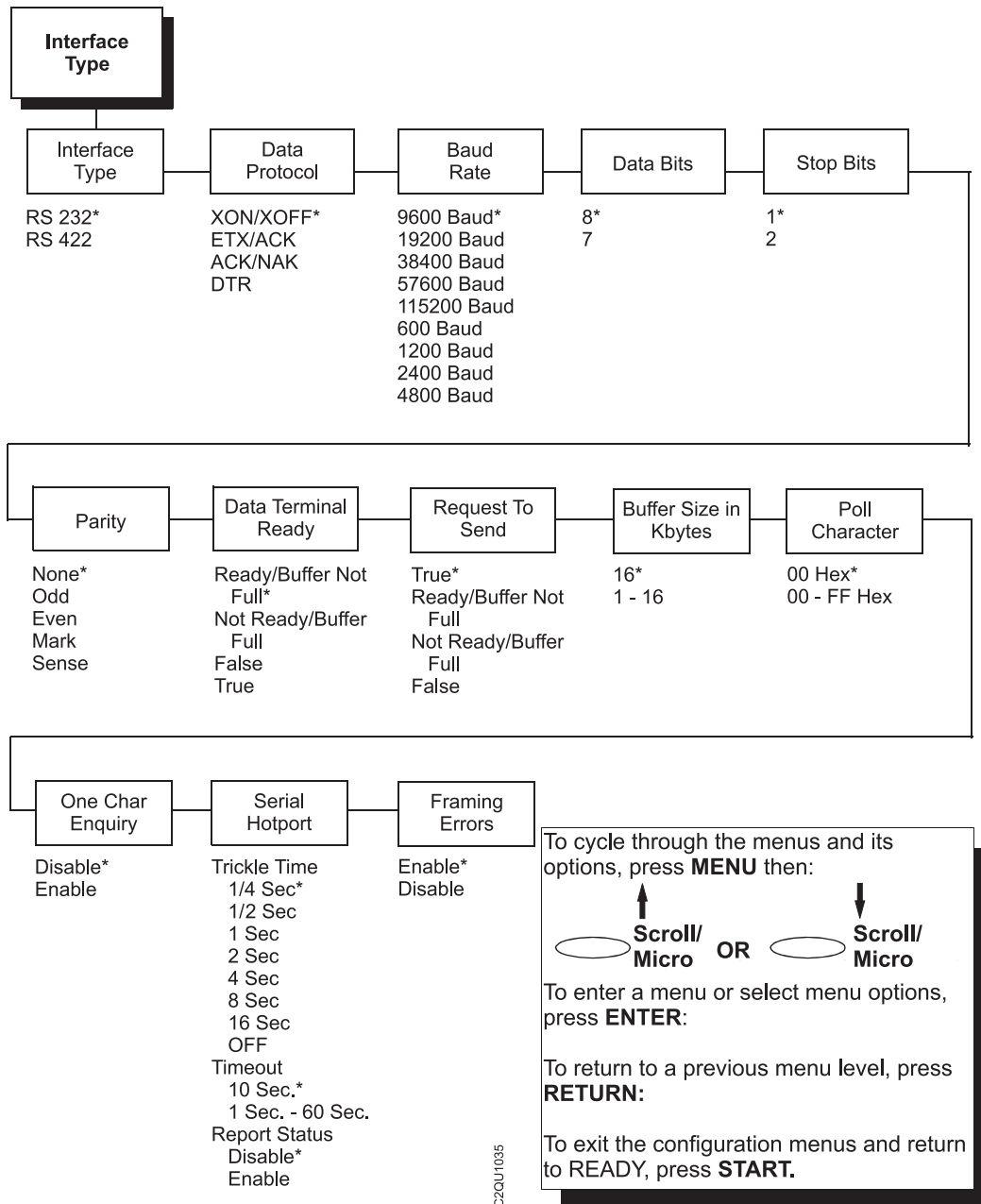

Figure 45. Serial Interface Menu

Interface Type

This parameter configures the electrical interface for the serial port, as follows:

- **RS-232** (the default)
- **RS-422**

Data Protocol

You can select one of the following serial interface protocols to meet the host interface requirements.

- **XON / XOFF** (the default). Transmit On / Transmit Off. The printer controls the flow of communication from the host by telling the host to turn the transmission on and off. This is the factory default serial protocol.
- **ETX / ACK**. End of Text / Acknowledge. The host controls the flow of communication to the printer by sending a block of data and ending the block with an End of Text (ETX) signal. When the printer receives the ETX signal, it will acknowledge the ETX, thereby acknowledging it has received the entire block of data.
- **ACK / NAK**. ACK means acknowledge; the device acknowledges it has accepted a transmission. NAK means negative acknowledge; the device did not receive the transmission.
- **DTR (DTE Ready)**. The printer controls the data flow by asserting or deasserting this hardware signal to the host. If there is enough room in the printer buffer, the printer will send a high signal; if the buffer is full the printer will send a low signal. DTR tells the host if it is safe to send more data. (If the host sends data during an unsafe condition, data will be lost.)

Baud Rate

This parameter sets the baud rate of the serial interface in the printer. Baud rate is the speed at which serial data is transferred between the host computer and the printer.

- **9600 Baud** (the default)
- **19200 Baud**
- **38400 Baud**
- **57600 Baud**
- **115200 Baud**
- **600 Baud**
- **1200 Baud**
- **2400 Baud**
- **4800 Baud**

Data Bits

The DATA BITS parameter sets the length of the serial data word. The length of the data word must match the corresponding data bits setting in the host computer.

- **8** (the default)
- **7**

Stop Bits

The STOP BITS parameter sets the number of stop bits in the serial data word. The setting must match the corresponding stop bit setting in the host computer.

- 1 (the default)
- 2

Parity

The PARITY parameter setting can be set for the following:

- **None** (the default)
- **Odd**
- **Even**
- **Mark**
- **Sense**

The setting must match the corresponding parity setting in the host computer.

Data Terminal Ready

This configuration is part of hardware flow control and determines when the DATA TERMINAL READY (DTR) signal is generated. This signal indicates whether or not the printer is ready to receive data.

- **Ready/Buffer Not Full** (the default). Asserts the DTR signal when the printer is READY and the internal serial buffer is not full.
- **Not Ready/Buffer Full**. Asserts the DTR signal when the printer is NOT READY or the internal serial buffer is full.
- **False**. Never asserts the DTR signal.
- **True**. Continuously asserts the DTR signal.

Note: When the printer is attached to an System i, the DTR should be set to TRUE.

Request to Send

This configuration is part of hardware flow control and determines when the REQUEST TO SEND (RTS) signal is generated. This signal indicates whether or not the printer is ready to receive data.

- **True** (the default). Continuously asserts the RTS signal.
- **Ready/Buffer Not Full**. Asserts the RTS signal when the printer is READY and the internal serial buffer is not full.
- **Not Ready/Buffer Full**. Asserts the RTS signal when the printer is NOT READY or the internal serial buffer is full.
- **False** never asserts the RTS signal.

Note: Xon/Xoff is always on. See “Data Protocol” on page 128 for more information.

Buffer Size in Kbytes

This parameter determines the size of the input buffer, in 1K increments. Up to 16K are available.

- **16** (the default)
- **1 - 16**

Poll Character

This option is used when One Char Enquiry is enabled and the IGP feature is available. Whenever the printer receives this character, it sends a response to the host indicating the current state of the printer. It may be configured from X'00' through X'FF' Hex.

- **X'00' Hex** (the default)
- **X'00' - X'FF'**

One Char Enquiry

When enabled, and the IGP feature is available, a status byte is sent back to the host when the poll character or the command SFCC enquiry is sent to the printer (serial interface only). The poll character is received and the status byte is sent whether the printer is online or offline. The SFCC enquiry will only be processed when the printer is online.

- **Disable** (the default)
- **Enable**

The status byte sent to the host is defined as follows:

BIT	Use
7.6	0
5	1
4	0
3	1 = printer fault
2	1 = IGP busy
1	0 = offline, 1 = online
0	1 = serial input buffer exceeds xoff/on

Serial Hotport

Gives the printer the ability to handle multiple data streams simultaneously. It allows the printer to service hosts attached to the serial, parallel, and either Coax or Twinax ports as if they were the only interface connected.

Trickle Time

This functionality prevents an attached host from timing out. To support this feature, the port has to be able to accept data from the host and store it for future use. The selected value is the time that the printer waits before getting the next byte of data from the host. Set the value to be less than the host time out value. If the value is too much shorter, the printer fills up its buffer too fast. This function is not applicable for C/T Hotport.

- $\frac{1}{4}$ Sec (the default)
- $\frac{1}{2}$ Sec
- 1 Sec
- 2 Sec
- 4 Sec
- 8 Sec
- 16 Sec
- OFF

Timeout

This is the value used by the printer to time out from the current port and check the other ports for data to print. When the printer has not received data from the host after a certain period of time, it needs to Timeout in order to service the other ports.

- **10 Sec** (the default)
- **1 Sec - 60 Sec**

Report Status

When this option is enabled, faults are reported even if the fault is not on the current active port. If the option is disabled, a fault on the printer is reported only if it occurs on the active port.

- **Disable** (the default)
- **Enable**

Framing Errors

These are possible errors that can occur when serial interface settings of the printer do not match those of the host computer.

- **Enable** (the default). If a framing error occurs, a fault message will display on the control panel.
- **Disable**. If a framing error occurs, a fault message will not display on the control panel.

Emulation Configuration Menu

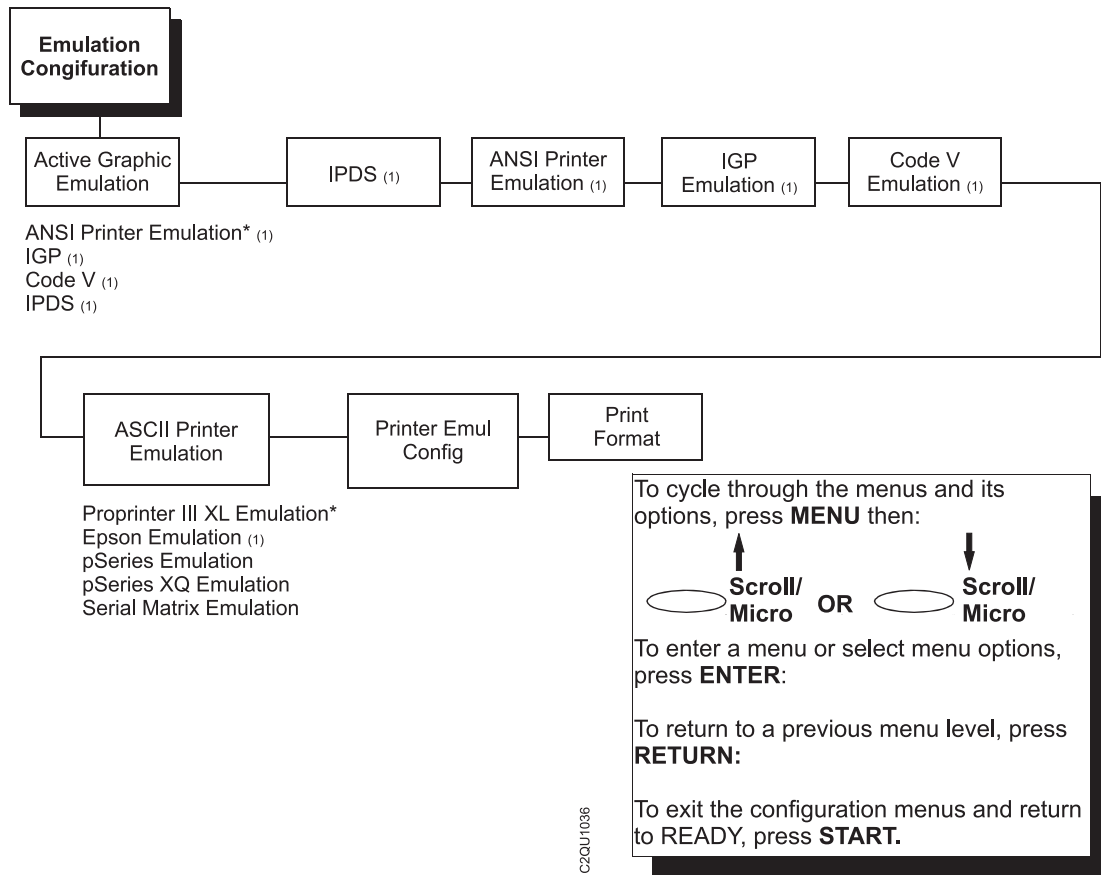

Notes:

1. if installed

Figure 46. Emulation Configuration Menu

Your printer can support many emulations: Proprinter III XL, Epson, pSeries, pSeries XQ, and Serial Matrix. These emulations are included with your printer.

Your printer can support other emulations: IPDS, Code V, and IGP. These emulations are features that must be ordered separately. (These features may have been installed at the factory if the features were ordered with the printer.) For the IPDS Coax/Twinax emulation, the Coax/Twinax feature must be installed.

Active Emulation

This parameter allows you to select either of the following emulations:

- **ANSI Emulation** (the default).
- **IGP**. See “IGP Emulation Menu” on page 151.
- **Code V**. See “Code V Emulation Menu” on page 157.
- **IPDS**.

ASCII Printer Emulation

This parameter selects one of the following ASCII printer emulations as the active emulation:

- **pSeries Emulation** (the default)
- **pSeries XQ Emulations**
- **Serial Matrix Emulation**
- **Proprinter III XL Emulation**
- **Epson Emulation**

The configuration for the active emulation is selected from the Printer Emulation Configuration menu, described in “Emulation Configuration Menu” on page 133.

Printer Emulation Configuration

This parameter configures the ASCII printer emulation and page formatting. The submenus are described in “Printer Emul Config Menu” on page 166).

Print Format

This parameter configures page formatting. The submenus are described beginning in “Print Format Menu” on page 181.

IPDS Feature

Configuration

Matching printer operational settings to those of the host computer is known as “printer configuration”. The settings, or configuration parameters, such as selecting the host interface, are adjusted according to the operator panel key descriptions. Configure the IPDS in the same way you would configure the printer for other features.

You can select IPDS default parameters directly from the operator panel as explained in this chapter, or by application commands as explained in the *InfoPrint 6500 IPDS Programmer’s Reference Manual*.

IPDS Parameters

The IPDS parameters are described on the following pages. Parameters marked with an asterisk (*) indicate the default value. The printer must be offline to enter the configuration structure.

Enter and exit the IPDS configuration menu according to the configuration procedures in Chapter 3, "Configuring the Printer," on page 19. Pressing an invalid key to enter a parameter value may move you to another level in the configuration or exit the configuration menu completely.

BEFORE you reconfigure the IPDS, print a configuration sheet to see all of the current settings. Refer to "Printing the Current Configuration" on page 28.

Configure the IPDS according to your specific requirements. The IPDS configuration menu is shown on the following page.

IPDS Configuration Menu

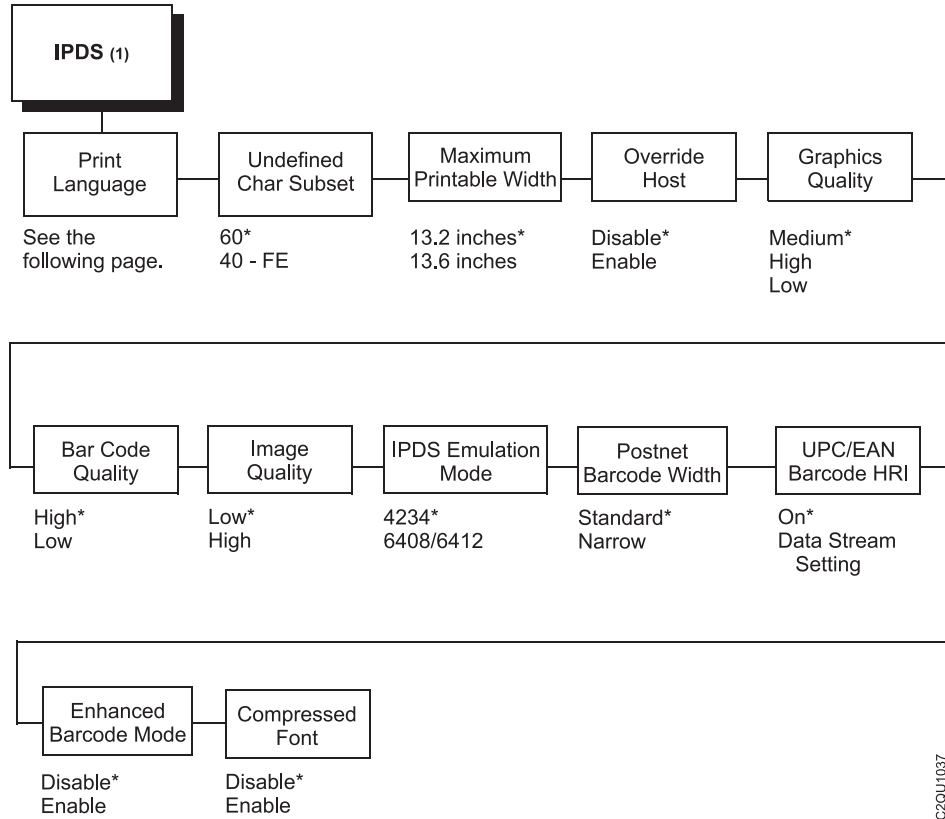

Figure 47. IPDS Configuration Menu

Print Language

0037 English (USA/Can)*
0037 English (Holland)
0285 English (UK)
0273 Austrian/German
0274 Belgian Old
0275 Brazilian
0260 Canadian French
0277 Danish/Norwegian
0287 Danish/Norway (Alt)
0278 Finnish/Swedish
0288 Finnish/Swed (Alt)
0297 French/Azerty
0500 Internatl Set 5
0280 Italian
0281 Japanese English
0282 Portuguese
0284 Spanish/Sp Speaking
0289 Spanish (Alt)
0500 Swiss Bilingual
0500 Belgian New
0803 Hebrew Old (089)
0424 Hebrew
0892 OCR A
0893 OCR B
0420 Arabic
0880 Cyrillic Old
0423 Greek Old
0875 Greek New Euro
0871 Icelandic
0290 Japanese Katakana
0870 Latin2/Roece/Multi
0838 Thai
1026 Turkish
0890 Yugoslav Old
1097 Farsi
1025 Cyrillic Multilingl
0256 Internatl Set 1
0924 Euro Latin 9
1140 Euro Eng (USA/CA)
1141 Euro Aust/German
1142 Euro Danish/Norway
1143 Euro Finnish/Swed
1144 Euro Italian
1145 Euro Spanish Speake
1146 Euro English (UK)
1147 Euro French Azerty
1148 Euro Swiss Bilingl
1149 Euro Icelandic
1112 Baltic Multilingl
1122 Estonian
OCR-B Katakana

To cycle through the menus and its options, press **MENU** then:

↑
○ **Scroll/**
Micro OR ○ **Scroll/**
Micro ↓

To enter a menu or select menu options, press **ENTER**:

To return to a previous menu level, press **RETURN**:

To exit the configuration menu and return to **READY**, press **START**.

C2QU1038

Figure 48. IPDS Configuration Menu - Print Language

Print Language (TCP/IP IPDS)

PRINT LANGUAGE specifies the set of print languages used by the printer. Refer to the previous page for print language menus.

Specifying a print *quality* of OCR A or OCR B will change the print language to OCR A or OCR B.

When OCR A or OCR B is selected as the default print language, OCR A and OCR B are the only available values for this parameter. If a different print quality value is desired, the print language must be changed first.

Note: This configuration value applies only to IPDS on the Ethernet. For Coax or Twinax IPDS, use the corresponding configuration value in the Coax or Twinax Interface menu.

Undefined Character Substitution (TCP/IP IPDS)

Undefined Character Substitution specifies the replacement character to print in place of any unprintable character that is received by the host.

- X'60' (the default)
- X'40' - X'FE'

Note: This configuration value applies only to IPDS on the Ethernet. For Coax or Twinax IPDS, use the corresponding configuration value in the Coax or Twinax Interface menu.

Maximum Printable Width (TCP/IP IPDS)

Maximum Printable Width sets the maximum width of the printer when using an IPDS host interface.

- 13.2 Inches (the default)
- 13.6 Inches

Note: This configuration value applies only to IPDS on the Ethernet. For Coax or Twinax IPDS, use the corresponding configuration value in the Coax or Twinax Interface menu.

Override Host (Emulation Configuration)

Override Host determines if the operator panel overrides specified IPDS menu values.

Select one of the following two values:

- **Disable** (the default). Does not allow operator panel settings to override IPDS application commands.
- **Enable**. Allows operator panel settings to override IPDS application commands.

The specified IPDS application commands for the IPDS menu values are:

- **Graphics Quality**
- **Bar Code Quality**
- **Image Quality**

Note: No other IPDS menu values or printer operator panels are affected by Override Host. Only the three values listed above are affected.

Graphics Quality

Determines the quality for graphics printing. Override Host must be enabled to use these settings. Here are the supported resolutions in pels:

- **Medium** (the default). Vertical is 144; horizontal is 120.
- **High**. Vertical is 144; horizontal is 180.
- **Low**. Vertical is 72; horizontal is 60.

Note: The higher the resolution selected, the slower the print speed. When selecting a resolution, try to balance the resolution quality your application requires with how fast you want the print job to print.

Bar Code Quality

Determines the quality for graphics printing. Override Host must be enabled to use these settings. Below are the values for non-rotated bar codes.

- **High** (the default). Vertical is 144; horizontal is 120.
- **Low**. Vertical is 72; horizontal is 60.

Note: The higher the resolution you select, the slower the print speed. When selecting a resolution, try to balance the resolution quality your application requires with how fast you want the print job to print.

Image Quality

Determines the quality for image printing. Override Host must be enabled to use Image Quality. If Override Host is disabled, then the image is assumed to be 144 by 144 and the image is printed at 120 by 144.

- **Low** (the default). Accepts images with 144 by 144 and prints images at 120 by 144. With this setting, the image is converted from 144 by 144 to 120 by 144. Since there is some conversion required, there may be some differences between the original image and the printed image. Review the note below for more information.
- **High**. Accepts images with 120 by 144 and prints images 120 by 144. With this setting, the image is printed as is and requires no conversion. Because no conversion is required, there is more fidelity between the original image and the printed image.

Note: There is one bit of image data per pel. If your print job contains an image created to print 144 by 144, which is very common for IBM 4234 printers, some bits of data will be dropped out to support the best fit resolution, which is 120 by 144.

When printing jobs with images created for an IBM 4234 printer, you will want to print a few samples to ensure the results are satisfactory.

IPDS Emulation Mode

Select which type of printer you want IPDS to support. You can choose either to emulate a 4234 or you can choose 6408/6412. You should choose which mode you use based on your software applications. For instance, if you are using PSF/MVS, then you would choose 6408/6412 as PSF/MVS provides support for this printer.

- **4234** (the default). IPDS supports 4234 printer functions. This is the default which should be used most often. If you are using IPDS with PSF applications, except PSF/MVS, make sure you select 4234.

Please review Chapter 3, "IPDS Commands Reference" in your *InfoPrint 6500 IPDS Programmer's Reference Manual* for information on using IPDS commands when you select 4234 from the IPDS Emulation Mode menu.

- **6408/6412**. IPDS supports 6408/6412 printer functions. Use this value when you are using IPDS with PSF/MVS. This value enables IPDS and PSF/MVS to take advantage of 6408/6412 printer functions which are supported directly by PSF/MVS. Other PSF applications only support this printer as a 4234 printer.

Please review Chapter 4, "IPDS Command Differences" in your *InfoPrint 6500 IPDS Programmer's Reference Manual* for information on using IPDS commands when you select 6408/6412 from the IPDS Emulation Mode menu.

Note: If you want to use the value 6408/6412 as the default value, you will need to select 6408/6412 as the default, save the value as a custom set, and then power the printer off and back on again.

Postnet Barcode Width

Determines the width of Postnet bar code. This option applies to non-rotated Postnet bar codes.

- **Standard** (the default). Postnet bar codes are printed at the standard width.
- **Narrow**. Postnet bar codes are printed with a narrow width.

Note: The printer caches bar codes to improve performance. Therefore, to change this configuration value, you will need to select the desired setting, save the value in a custom set, then power the printer off and then prewar the printer back on.

UPC/EAN Barcode HRI

Determines whether bar code HRI (human readable information) prints with UPC and EAN bar codes.

- **On** (the default). The printer always prints HRI with UPC and EAN bar codes, regardless of the HRI flag contained in the IPDS bar code application command.
- **Data Stream Setting**. The printer uses the HRI flag in the IPDS bar code application command to determine whether or not to print HRI with UPC and EAN bar codes. See the *InfoPrint 6500 IPDS Programmer's Reference Manual* for more information about IPDS bar code application commands.

Enhanced Bar Code Mode

The Enhanced Bar Code Mode option interweaves the dots in IPDS bar codes so that more bar codes can be printed before the printer ribbon must be replaced.

- **Disable** (the default). Bar codes are printed in one of the standard qualities, as determined by the Bar Code Quality option and IPDS application commands.
- **Enable**. Bar codes are printed in the enhanced mode.

Only certain bar code types, sizes, and orientations are supported in Enhanced Bar Code Mode.

- Only bar codes with a unit module width of 0.017 inches are supported in Enhanced Bar Code Mode.
- For non-rotated bar codes, all bar code types except Postnet and Royal Mail are supported in Enhanced Bar Code Mode. Enhanced bar codes printed in these orientations will print at approximately the same speed as standard high quality bar codes.

- For rotated bar codes, all bar code types except Postnet, Royal Mail, UPC, EAN, and Code 128 are supported in Enhanced Bar Code Mode. Enhanced bar codes printed in these orientations will print slower than standard high quality bar codes.

Note: Bar codes that are printed in Enhanced Bar Code Mode that are not supported in this mode will print in standard high quality.

Compressed Font

The Compressed Font option allows the printer to print vertically compressed (short) fonts available on the IBM 4234 IPDS printer.

- **Disable** (the default). Normal size fonts are substituted whenever compressed fonts are requested.
- **Enable**. Compressed fonts are printed when requested by IPDS application commands. See the *InfoPrint 6500 IPDS Programmer's Reference Manual* for more information about selecting these fonts with application commands.

ANSI

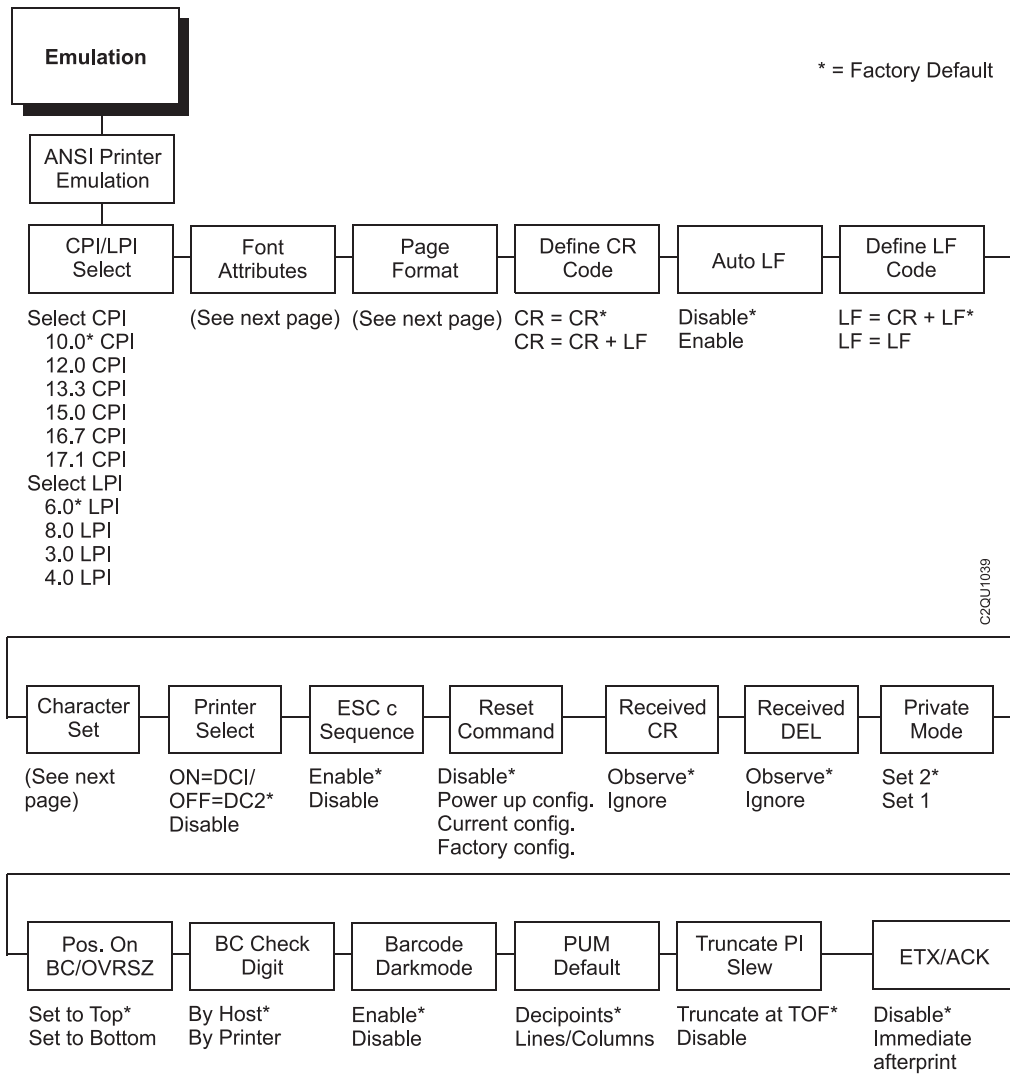

Figure 49. ANSI Emulation Menu

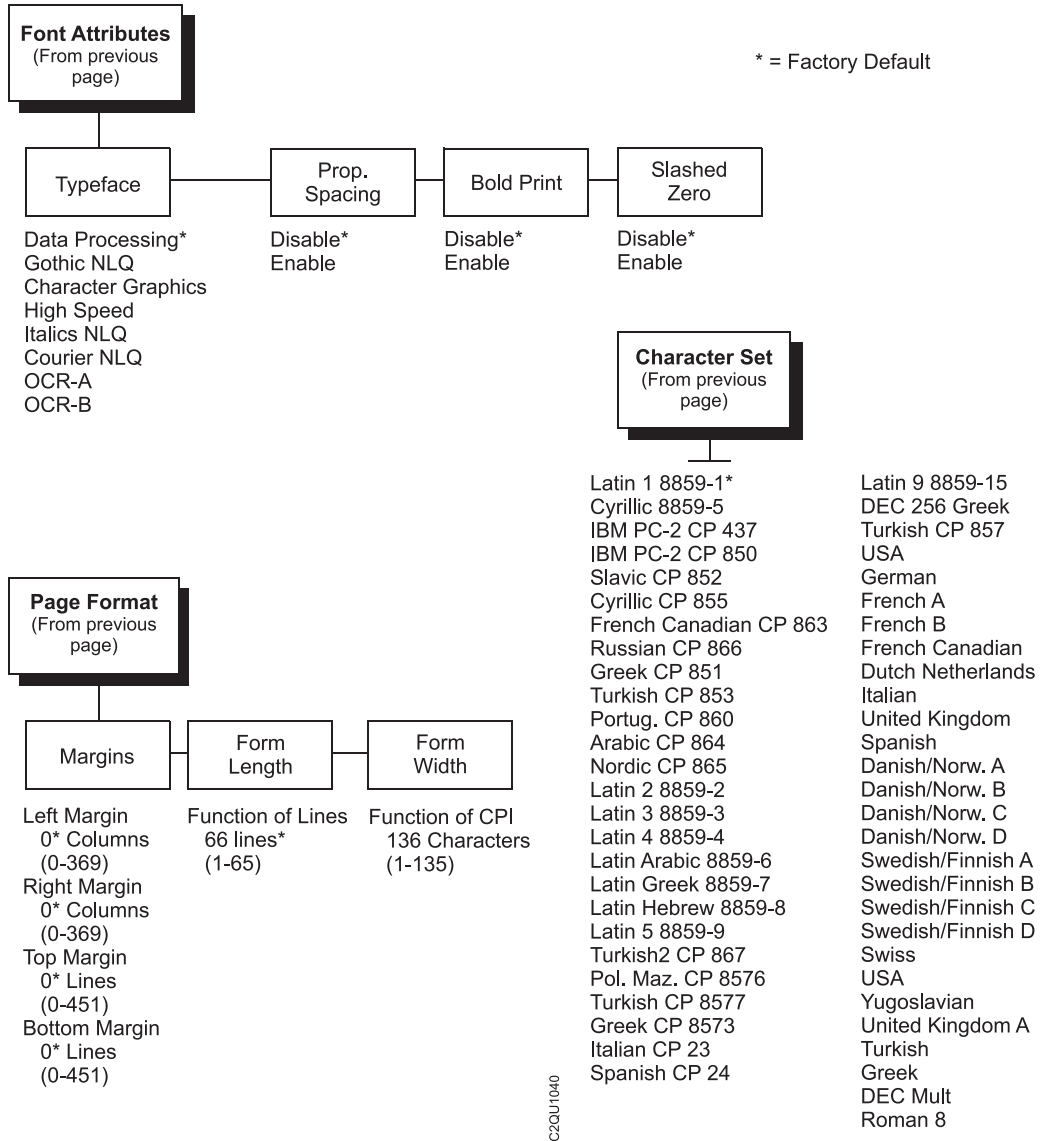

Figure 50. ANSI Emulation Menu - Font Attributes, Character Set, and Page Format Menus

CPI/LPI Select

Defines the default values for the horizontal and vertical character spacing. The number of characters per inch can range from 10.0 through 17.1. The number of lines per inch can range from 3.0 through 8.0.

CPI Select

- 10.0 CPI (the default)
- 12.0 CPI
- 13.3. CPI
- 15.0 CPI
- 16.7 CPI
- 17.1 CPI

Select LPI

- 6.0 LPI (the default)
- 3.0 LPI
- 4.0 LPI
- 8.0 LPI

Font Attributes

Typeface

Choose a typeface from the available options:

- **Data Processing** (the default). A general purpose font printing out at 120 dpi horizontally and 72 dpi vertically. The width of the font will vary with each cpi.
- **Gothic NLQ**. A high quality font printing at 180 dpi horizontally and 96 dpi vertically. This font has serifs and the width of the font varies with the cpi.
- **Character Graphics**.
- **High Speed**. A draft quality font printing at 120 dpi horizontally and 48 dpi vertically. The width of the font varies with the cpi.
- **Italics NQL**.
- **Courier NQL**.
- **OCR-A / OCR-B**. Optical character recognition fonts printing at 120 dpi horizontally and 144 dpi vertically. Both fonts print only at 10 cpi.

Prop. Spacing (Proportional Spacing)

Each printed character is contained inside a character cell. The width of the character cell includes the character and the space around the character.

- **Disable** (the default). Each character cell is printed with the same width. Each column in the printed text will line up.

This example is printed with
proportional spacing disabled

- **Enable**. The width of each character cell varies with the width of the character. For example, [i] takes less space to print than [m]. Using proportional fonts generally increases the readability of printed documents, giving text a typeset appearance.

This example is printed with
proportional spacing enabled

Bold Print

- **Disable** (the default). Text is printed normally.
- **Enable**. Text is printed with a heavy line thickness.

Slashed Zero

This parameter allows you to print the numeral “0” with or without the slash. This option applies to all character sets except OCR-A and OCR-B.

- **Disable** (the default). Zero is printed without a slash.
- **Enable**. Zero is printed with a slash.

Page Format

Margins

- **Left Margin.** Defines where the first print column is located. The left margin is specified as the number of characters from the left edge of the form.
- **Right Margin.** Defines where the last print column is located. The right margin is specified as the number of characters from the right edge of the form.
- **Top Margin.** Defines the location of the first print line on the page. The top margin is specified as the number of lines from the top of the form's position.
- **Bottom Margin.** Defines the location of the last print line on the page. The bottom margin is specified as the number of lines from the bottom of the form's position.

Form Length

Specifies the form length in lines. The maximum form length in lines depends on the current LPI setting; it is equal to the maximum form length in inches multiplied by the current LPI setting. For example, at 6 LPI the maximum form length is 6 LPI x 24 inches = 144 lines.

Only valid form length values will be accepted. If you select a length that is larger than the maximum length for the current LPI, the maximum length will be used. If you need a longer page length, you must first change the LPI. The default is 66 lines.

IMPORTANT: If the form length is set in lines and you change the LPI, the effective page length changes to the form length in characters divided by the new LPI.

Note: Receipt of a data stream control code which changes the form length overrides the form length previously specified via the operator panel.

Form Width

Allows you to input the form width in characters from 1 through 272. The maximum form width in characters depends on the current CPI setting; it is equal to the maximum form width in inches multiplied by the current CPI setting.

Only valid form width values will be accepted. If a width is selected that is larger than the maximum width for the current CPI, then the maximum width will be used. If a larger width value is desired, then the CPI value must be changed first. The default is 136 lines.

Table 3 lists the maximum number of characters that can be printed for a given Characters Per Inch (CPI) setting.

IMPORTANT: If the form width is set in characters and the CPI is changed, the effective page width is changed to be equal to the form width in characters divided by the new CPI.

Table 3. Form Width

CPI Setting	Maximum Form Width (in characters)
10.0	136
12.0	163
13.3	181
15.0	204
16.7	227
17.1	272

Define CR Code

The Define CR Code option controls the action of the printer when it receives a Carriage Return code (X'0D') from the host computer. If this feature is enabled, each time the printer receives a carriage return, it inserts an additional Line Feed code (X'0A') into the data stream. Do not use this feature if the host computer sends line feeds to the printer.

- **CR = CR** (the default). No extra line feeds are inserted.
- **CR = CR + LF**. Inserts an extra line feed after each carriage return.

Auto LF

Defines the printer actions when print data is received past the form width setting.

- **Disable** (the default). Discards any data past the form width.
- **Enable**. Performs an automatic carriage return and line feed when data is received past the form width.

Define LF Code

Controls the action of the printer when it receives a Line Feed code (X'0A') from the host computer. If this feature is enabled, each time the printer receives a line feed, it inserts an additional carriage return code (X'0D') into the data stream. This feature can be used in most installations, but it is required if the host computer does not send carriage returns to the printer.

- **LF = CR + LF** (the default). Adds an extra carriage return with each line feed.
- **LF = LF**. Does not add a carriage return with a line feed.

Character Set

This parameter selects a character set for the ANSI emulation. Note that when 0876 OCR-A or 0877 OCR-B is selected as the print language, the Font Attributes Typeface parameter is changed to OCR-A or OCR-B, respectively. Character sets are shown in detail in the *Character Sets Reference Manual*.

Printer Select

- **ON = DC1/OFF = DC3** (the default). Disables the printer when a DC1 control code is received, and enables the printer when a DC3 control code is received.
- **Disable**. Ignores the DC1 and DC3 control codes.

ESC c Sequence

- **Enable** (the default). An ESC c code received from the host resets the printer parameters to the factory defaults.
- **Disable**. An ESC c code received from the host is ignored.

Reset Command

When the printer receives a host data stream reset command (ESC @ or ESC[K) in addition to resetting printer variables, the selected configuration will be loaded.

- **Disable** (the default). The active emulation parameters are loaded when the reset command is executed.
- **Power-Up Config**. The power-up configuration is loaded when the reset command is executed.
- **Current Config**. The currently selected configuration is loaded when the reset command is executed.
- **Factory Config**. The factory installed configuration is loaded when the reset command is executed.

Received CR

- **Observe** (the default). A CR code received from the host is handled as a carriage return.
- **Ignore**. A CR code received from the host is ignored.

Received DEL

- **Observe** (the default). A DEL code received from the host is handled as a Delete command.
- **Ignore**. A DEL code received from the host is ignored.

Private Mode

Determines the default type of character set (Set 1 or Set 2). This can also be set by ESC sequences ESC [>5h and ESC [>5l. Refer to these descriptions in the *ANSI Programmer's Reference Manual* for further details.

- **Set 2** (the default)
- **Set 1**

Pos. on BC/OvrSz

- **Set to Top** (the default). The paper is fed back to the top of barcodes or oversized characters after they are printed. This allows printing on the same line.
- **Set to Bottom**. The printer will continue printing without backing up.

BC Check Digit

- **By Host** (the default). The host calculates the barcode check digit and sends it along with the barcode. The check digit is not verified by the printer but printed as it was received.
- **By Printer**. The barcode is sent without the check digit, and the printer calculates and adds it in.

Barcode Darkmode

- **Enable** (the default). The barcodes are printed at a higher resolution.
- **Disable**. The barcodes are printed at lower resolution but at a higher speed.

PUM Default

This is the Unit of Measure (UOM) as it is used within the ANSI emulation. Coordinates received in ESC sequences can be sent in two UOMs: Decipoints, which is a unit of 1/720 inch, or in lines or columns using the current LPI and CPI values. The UOM used is determined by this configuration setting.

- **Decipoints** (the default)
- **Lines/Columns**

Truncate PI Slew

- **Truncate at TOF** (the default). The slew is terminated when the next Top-of-Form is reached. (This function applies to the ANSI EVFU only).
- **Disable**. PI slews will be completed independent of their length.

ETX/ACK

End of Text/Acknowledge. The host controls the flow of communication to the printer by sending a block of data and ending the block with an End of Text (ETX) signal. When the printer receives the ETX signal, it acknowledges the ETX, thereby acknowledging it has received the entire block of data.

- **Disable** (the default)
- **immediate**
- **afterprint**

IGP Feature (PGL)

Configuration

Matching printer operational settings to those of the host computer is known as “printer configuration”. The settings, or configuration parameters, such as selecting the host interface, are adjusted according to the operator panel key descriptions. Configure the IGP feature in the same way you would configure the printer for other features.

You can select IGP default parameters directly from the operator panel as explained in this chapter, or by control codes as explained in the *InfoPrint 6500 IGP User’s Manual*.

IGP Parameters

The IGP parameters are described in the following pages. Parameters marked with an asterisk (*) indicate the default value. The printer must be off-line to enter the configuration structure.

Enter and exit the IGP configuration menu according to the configuration procedures in Chapter 3, “Configuring the Printer,” on page 19. Pressing an invalid key to enter a parameter value may move you to another level in the configuration or exit the configuration menu completely.

IMPORTANT: BEFORE you reconfigure the IGP, print a configuration sheet to see all of the current settings. Refer to Chapter 3, “Configuring the Printer,” on page 19.

Configure the IGP according to your specific requirements.

The IGP configuration menu is shown on the following page.

IGP Emulation Menu

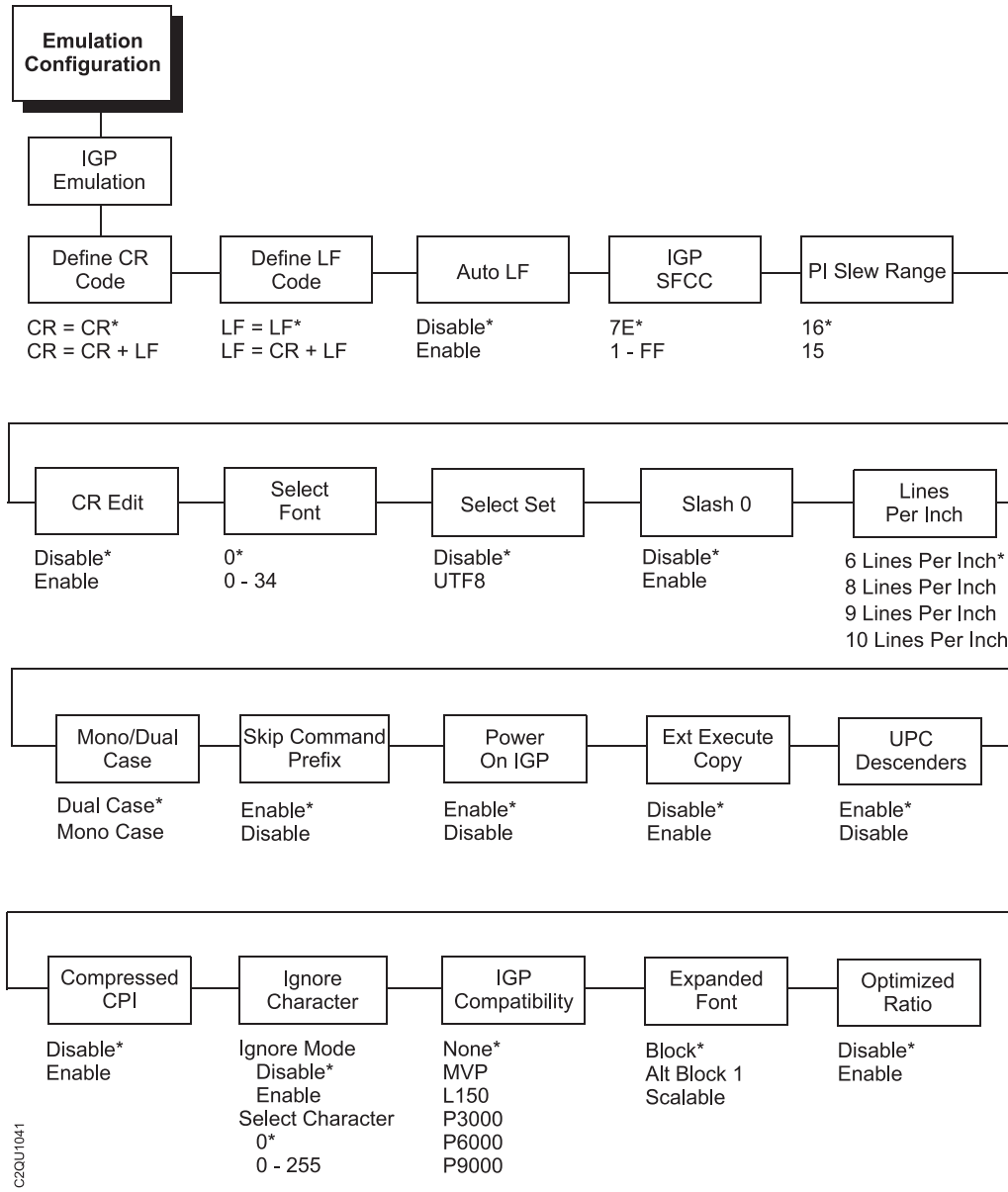

Figure 51. IGP Emulation Menu

Define CR Code (Carriage Return)

This parameter forces the printer to insert an automatic Line Feed code into the data stream whenever a Carriage Return code occurs. This is to be used only if the host computer does not send Line Feeds to the printer.

- **CR = CR** (the default). Does NOT perform a line feed. The next print position will be print position 1 of the current line.
- **CR = CR + LF**. Performs an automatic line feed. The next print position will be print position 1 of the next line.

Define LF Code (Line Feed)

This parameter forces the printer to insert an automatic Carriage Return code into the data stream whenever a Line Feed code occurs. This can be used in most installations, but it is required if the host computer does not send Carriage Returns to the printer.

- **LF = LF** (the default). Does not perform an automatic carriage return. The next print position will be the current print position of the next line.
- **LF = CR + LF**. Performs an automatic carriage return. The next print position will be print position 1 of the next line.

Auto LF

This parameter determines if text will wrap to the next line when the line of text exceeds the right margin.

- **Disable** (the default). Truncates the text beyond the right margin until a CR or CR + LF is received.
- **Enable**. Automatically inserts a CR + LF after a full print line.

IGP SFCC

You can specify which hex code (X'1' - X'FF') will be used as the Special Function Control Character (SFCC). The SFCC denotes that the following data is an IGP command.

- X'7E' (factory default)
- X'1' - X'FF'

PI Slew Range

You can specify how many lines the paper will feed.

- **16** (the default). A paper slew of 0-15 will move 1-16 lines.
- **15**. A paper slew of 1-15 will move 1-15 lines. A paper slew of 0 will move 1 line.

CR Edit

This parameter determines if a carriage return will be followed by a line feed.

- **Disable** (the default). The printer ignores all carriage returns that are not followed by line feeds.
- **Enable**. The printer processes all carriage returns, even for those that are not followed by line feeds.

Select Set

- **Disable** (the default). Uses the character set selected in the Select Font menu.
- **UTF-8**. Selects the UTF-8 character set (Unicode encoded font).

Select Font

This parameter allows you to select a font for the IGP feature. Valid selections are 0 to 33. The following predefined values are available:

0	U.S. ASCII (the default)
1	German
2	Swedish
3	Danish
4	Norwegian
5	Finnish
6	English
7	Dutch
8	French
9	Spanish
10	Italian
11	Turkish
12	Japanese
13—23	Reserved
24—31	User Defined Sets
32	0858 PC Euro Multilingual
33	0923 Latin 9 8859–15

Values 14 — 23 are undefined and will default to 0. You can set values 24 — 31 to specific fonts; refer to the USET command.

Slash 0

This option allows you to select is zeros will print with or without a slash (Ø).

- **Disable** (the default). Prints zeros without a slash (0).
- **Enable**. Prints zeros with a slash (Ø) to distinguish zeros from the alphabetical capital "O".

Lines Per Inch

This is the number of lines to be printed per inch. For example, at 6 lpi there is 1/6-inch from the top of one print line to the top of the next print line. The following number of lines per inch may be selected:

- 6 (the default)
- 8
- 9
- 10

Mono/Dual Case

This parameter enables the printer to print text in all uppercase when using the ALPHA command.

- **Dual Case** (the default). The printer will print text in upper- and lowercase.
- **Mono Case**. The printer will print text in uppercase only.

Skip Command Prefix

This parameter determines if a data string before an IGP command will be ignored.

- **Enable** (the default). The printer ignores all text before an IGP command.
- **Disable**. The printer will print any data before an IGP command.

Power On IGP

You can set the IGP feature so that it is enabled or disabled when the printer is powered on.

- **Enable** (the default). The IGP is enabled when the printer is powered on. (The IGP feature is initialized in the Normal mode.)
- **Disable**. The IGP is disabled when the printer is powered on. (The IGP feature is initialized to the Quiet mode.)

Ext Execute Copy

- **Disable** (the default). Dynamic data, overlay data, etc. are not allowed if the optional Form Count parameter (number of forms to print) is specified as part of the Execute command. (This setting is IGP-100/200/400 compatible.)
- **Enable**. Dynamic data, overlay data, etc. are allowed within a form in which the Form Count parameter is specified in the Execute command. In this case, the exact same form (with identical dynamic data, and so forth) is printed for whatever the Form Count is. However, incremental data is not incremented since the page that is printing is exactly the same. Also, each form is printed on a separate page.

UPC Descenders

This parameter determines if a gap is left for human readable data in UPC/EAN bar codes, even if there is no human readable data. There will be no change if there is human readable data.

- **Enable** (the default). The IGP leaves a gap, even if there is no human readable data.
- **Disable**. The IGP does not leave a gap if there is no human readable data.

Compressed CPI

This parameter allows you to choose a compressed character for CPI instead of the normal height character.

- **Disable** (the default). The IGP does not use the compressed CPI font.
- **Enable**. The IGP uses the compressed CPI font.

Ignore Character

Ignore Mode: This parameter instructs the IGP to ignore the character selected under the Select Character menu.

- **Disable** (the default). The IGP does not ignore any characters.
- **Enable**. The IGP ignores the characters selected under the Selected Character menu.

Select Character: This instructs the IGP which character to ignore from the host.

- 0 (the default)
- 0 - 255

IGP100 Compatibility

This option allows backward compatibility with older printer models. If you want your new printer to emulate an older model, select from the following options:

- **None** (the default)
- **MVP**. Older printer model.
- **L150**. Older printer model.
- **P3000**. Older printer model.
- **P6000**. Older printer model.
- **P9000**. Older printer model.

Expanded Font

This option defines the type of expanded character the IGP/PGL will select. The following choices are:

- **Block** (the default). These are block characters compatible with the IGP-X00 printers.
- **Alt Block 1**. This is a customized block character set that is only available for the non-overlay multinational group of character sets.
- **Scalable**. These expanded characters have rounded edges.

Optimized Ratio

This option selects different bar code ratios for certain bar codes including Code 39 and interleaved 2 of 5. It is included for compatibility with IGP-X00 printers.

- **Disable** (the default). Use standard bar code ratios.
- **Enable**. Select the alternate bar code ratios.

Code V Feature (VGL)

Configuration

Matching printer operational settings to those of the host computer is known as printer configuration. The settings, or configuration parameters, such as selecting the host interface, are adjusted according to the configuration instructions in Chapter 3, "Configuring the Printer." Configure the Code V feature in the same way you would configure the printer for other features.

You can select Code V parameters directly from the operator panel as explained in this chapter, or by control codes as explained in the *InfoPrint 6500 Code V Programmer's Reference Manual*.

Code V Parameters

The Code V parameters are described on the following pages. Parameters marked with an asterisk (*) indicate the default value. The printer must be off-line to enter the configuration structure.

Enter and exit the Code V configuration menu according to the steps outlined in Chapter 3, "Configuring the Printer," on page 19. Pressing an invalid key to enter a parameter value may move you to another level in the configuration or exit the configuration menu completely.

BEFORE you re-configure the Code V, print a configuration sheet to see all of the current settings. Refer to Chapter 3, "Configuring the Printer," on page 19.

Configure the Code V according to your specific requirements.

The Code V configuration menu is shown on the following page.

Code V Emulation Menu

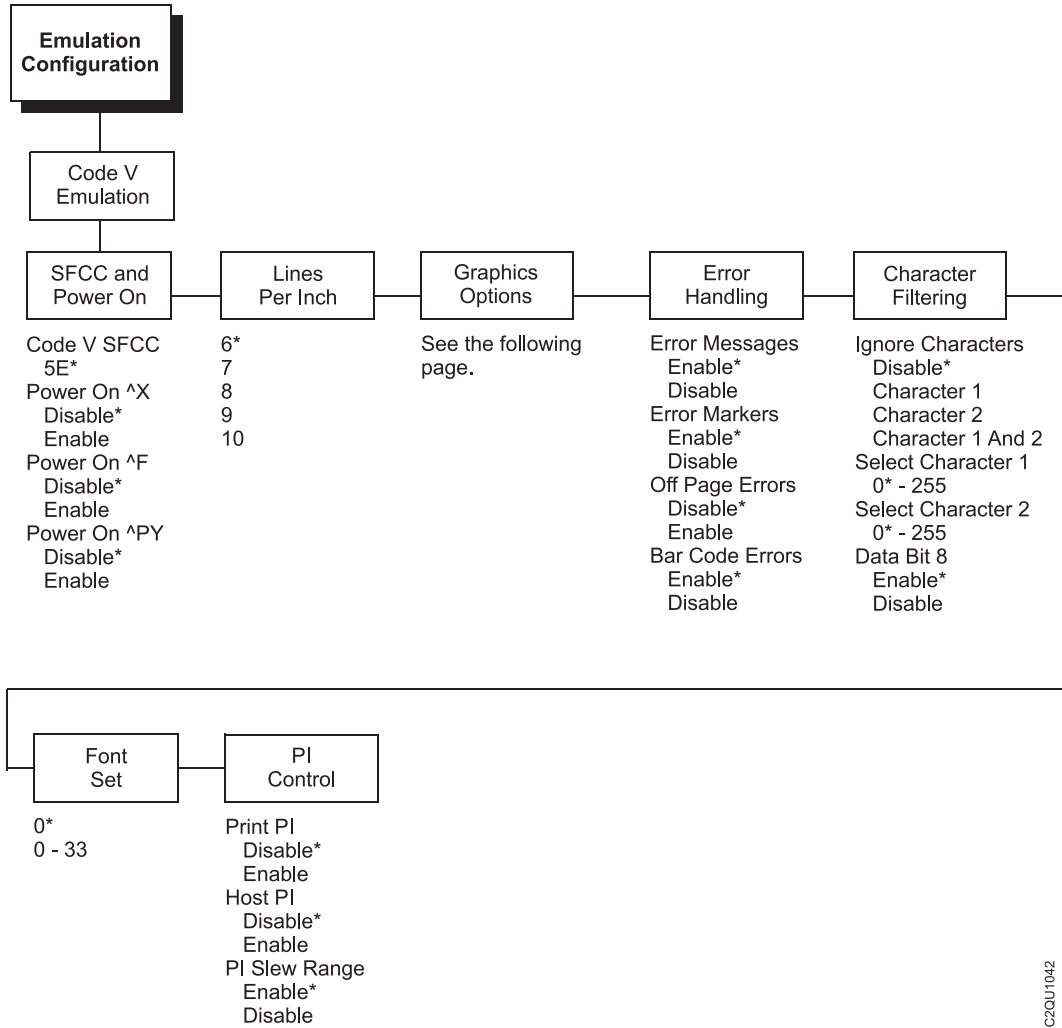

C20U1042

Figure 52. Code V Emulation Menu

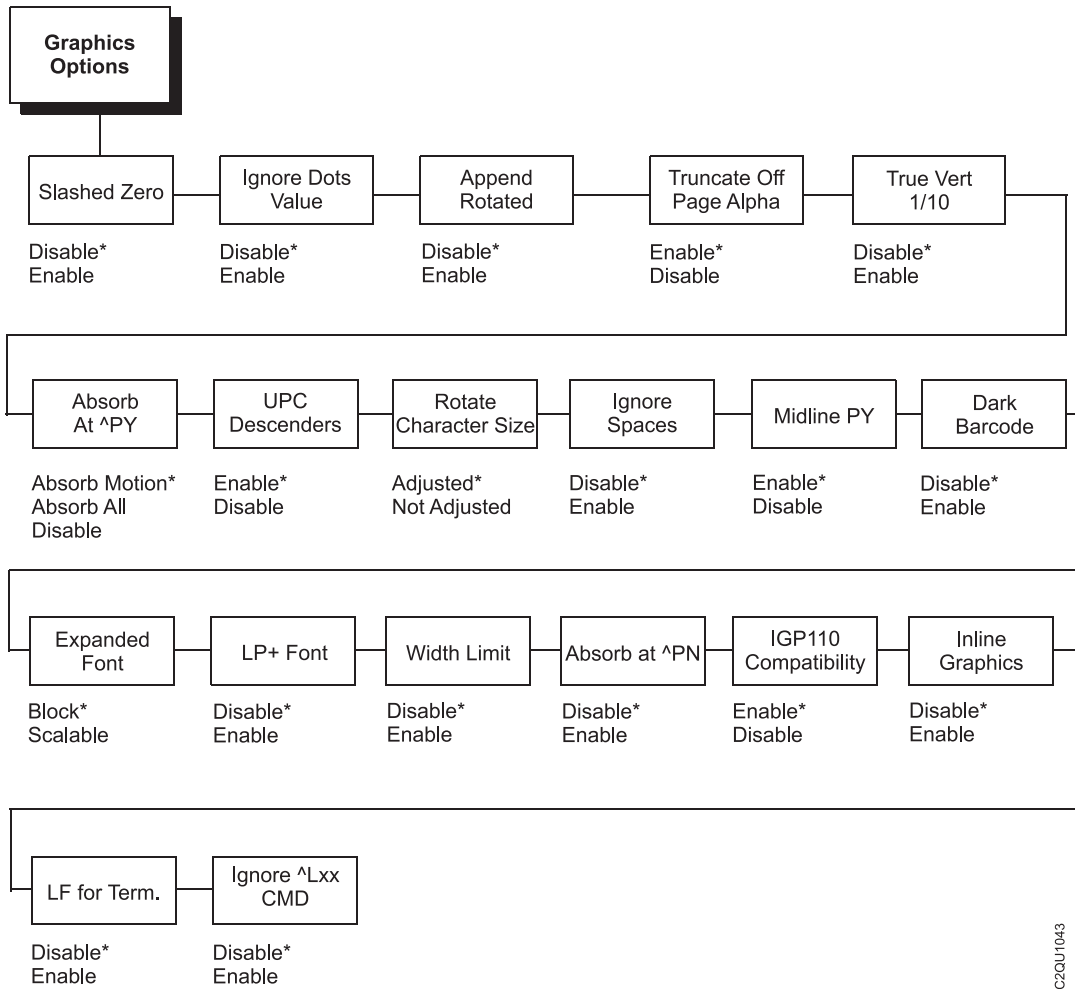

Figure 53. Code V Emulation Menu - Graphic Options

SFCC and Power On

Code V SFCC: Selects the Special Function Control Character. Valid values are X'11' through X'FF'. The default value is X'5E'. Always use the SFCC required for your configuration wherever the circumflex, or (cc) is shown. Obtain a configuration printout to determine the currently selected SFCC.

Power On ^X: Selects the ignore mode power up condition. Refer to the *InfoPrint 6500 Code V Programmer's Reference Manual* for more information.

- **Disable** (the default). Does not select the ignore mode as the power-up default.
- **Enable**. Selects the ignore mode as the power-up default, and selects the graphics mode (cc)PY as the power-up default. All characters are ignored until a (cc)A command is received.

Power On ^F: Enable Free format causes the Code V to ignore carriage returns, line feeds and all characters below X'20' sent from the host. Refer to the *InfoPrint 6500 Code V User's Manual* for more information on Free Format.

- **Disable** (the default). Does not select free format as the power-up default.
- **Enable**. Selects free format as the power-up default, and selects the graphics mode (cc)PY as the power-up default.

Power On ^PY: Selects the graphics mode power up condition. Refer to the *InfoPrint 6500 Code V Programmer's Reference Manual* for more information.

- **Disable** (the default). Does not select the graphics mode (cc)PY as the power-up default.
- **Enable**. Selects the graphics mode (cc)PY as the power-up default.

Lines Per Inch

Defines the number of lines per inch for the Code V to use. Can also be set by using the ^@L command. The following number of lines per inch may be selected:

- 6 (the default.)
- 7
- 8
- 9
- 10

Graphics Option

Slashed Zero:

- **Disable** (the default). Prints zeros without a slash (0).
- **Enable**. Prints zeros with a slash (Ø) to distinguish zeros from the alphabetical capital "O".

Ignore Dots Value:

- **Disable** (the default).
- **Enable**. Causes the Code V to expect position values to be specified in only 1/10 of an inch. If the dot position is also given, it is treated as text.

Append Rotated:

- **Disable** (the default). Appends logos to an alphanumeric string rotated in a clockwise, counterclockwise, or inverted orientation.
- **Enable**. When enabled, the logo is treated as a separate element.

Truncate Off Page Alpha: When enabled, this parameter prevents the printing of Error 48 (Element Off Page Error) if alphanumeric data, including spaces, extends beyond the right side of the form.

- **Enable** (the default).
- **Disable**

True Vertical 1/10: Determines if a vertical 1/10 of an inch parameter is used as 1/10 of an inch (Enabled) or as 7/72 of an inch (Disabled). When used as 1/10 of an inch, rounding will occur to the nearest 1/72 of an inch. This can cause vertical moves that have the same value to differ by $\frac{1}{72}$ of an inch. When used as 7/72 of an inch, the absolute move is slightly smaller than expected. For example, a one inch move would be $\frac{70}{72}$ of an inch. Vertical moves that have the same value will be identical in length.

- **Disable** (the default).
- **Enable**

Absorb at ^PY:

- **Absorb Motion** (the default). Prevents paper motion following a system terminator in a graphics (cc)PY command.
- **Absorb All**. When absorb all is selected, the system ignores all the data and terminator until a host generated terminator is detected.
- **Disable**. When disabled, system terminators following a graphics command are sent to the printer and result in paper motion.

UPC Descenders: This parameter determines if a gap is left for human readable data in UPC/EAN bar codes, even if there is no human readable data. There will be no change if there is human readable data.

- **Enable** (the default). Leaves a gap even if there is no human readable data.
- **Disable**. Does not leave a gap if there is no human readable data.

Rotate Character Size: The Rotated Character Size option determines if rotated (clockwise/counterclockwise), expanded characters have a different size than a non-rotated character with the same size parameters (Adjusted) or the same size (Not Adjusted).

- **Adjusted** (the default).
- **Not Adjusted**

Ignore Spaces:

- **Disable** (the default). Trailing spaces are NOT deleted from alphanumeric elements in a graphics pass.
- **Enable**. Trailing spaces are deleted from alphanumeric elements in a graphics pass.

Midline PY:

- **Enable** (the default). Allows printable characters to precede the ^PY command.
- **Disable**. Requires the ^PY command to be the first characters on a line.

Dark Barcode:

- **Disable** (the default). Bar codes are printed in normal mode.
- **Enable**. When enabled, prints all bar codes in a dark mode.

Expanded Font:

- **Block** (the default). These are block characters compatible with the IGP-X00 printers.
- **Scalable**. These expanded characters have rounded edges.

LP+ Font:

- **Disable** (the default). The IGP/VGL uses its default half-dot font, which is slightly different from the standard bitmap font used by LP+ at 12, 13, 15 and 17 cpi.
- **Enable**. The IGP/VGL uses the same font as used by LP+ at all cpi.

Width Limit:

- **Disable** (the default). This does not limit the width of expanded characters.
- **Enable**. When enabled, limits the width of expanded characters based on a fixed maximum ratio of width over height.

Absorb at ^PN:

- **Disable** (the default). When disabled, system terminators following the (cc)PN command are sent to the printer and result in paper motion.
- **Enable**. Prevents paper motion following the (cc)PN command.

IGP110 Compatibility:

- **Enable** (the default). This menu will process ^IPEXP commands in the same manner the IGP does, and does not expand special font characters if an ^IPEXP command precedes it.
- **Disable**. If disabled, it will allow the special font characters to be expanded.

Inline Graphics:

- **Disable** (the default). Requires the printer move to the beginning of the line to start a graphic.
- **Enable**. Permits Code V graphics to start in the middle of a print line as opposed to moving to the beginning of the line to start a graphic.

LF For Term:

- **Disable** (the default). The LF command (^,) used to terminate a graphic command sequence will not be performed as LF.
- **Enable**. The LF command (^,) used to terminate a graphic command sequence will be performed as LF.

Ignore ^Lxx Cmd.:

- **Disable** (the default). Checks command syntax and prints error messages when command parameters are incorrect.
- **Enable**. Suppresses error checking and error messages.

Error Handling**Error Messages:**

- **Enable** (the default). Checks command syntax and prints error messages when command parameters are incorrect.
- **Disable**. Suppresses error checking and error messages.

Error Markers:

- **Enable** (the default). Prints the following error markers for those elements that print beyond the page boundaries:
 - >> for elements that begin off the right side of the page;
 - << for elements that begin at the indicated position but end off the page
 - for elements where the starting position of the command contains an error other than an off-page error.
- **Disable**. Does not print error markers for those elements that print beyond the page boundaries.

Off Page Errors:

- **Disable** (the default). Does not report errors for elements that start or end beyond the right edge of the page.
- **Enable**. Reports errors for elements that start or end beyond the right edge of the page.

Bar Code Errors:

- **Enable** (the default). Prints an error message when invalid bar code data is encountered.
- **Disable**. Does not print an error for invalid bar code data and the bar code will be printed as is.

Character Filtering

Ignore Characters: Determines if character filtering is enabled, or if one or both characters are ignored.

- **Disable**. (the default.) Does not ignore the characters selected with the select character options.
- **Character 1**. The character selected using the Select Character 1 option will be ignored in the data string.
- **Character 2**. The character selected using the Select Character 2 option will be ignored in the data string.
- **Character 1 and 2**. Both characters selected using the Select Character 1 and Select Character 2 options will be ignored in the data string.

Select Character 1: Selects character 1 for the character filtering option.

- 0 (the default)
- 0 - 255 (decimal)

Select Character 2: Selects character 2 for the character filtering option. Valid values are from 0 through 255 (decimal).

- 0 (the default)
- 0 - 255 (decimal)

Data Bit 8:

- **Enable** (the default). The PI line is not passed directly from host to printer; all 8 bits are used for data bits, and characters in the X'80' - X'FF' range can be accessed.
- **Disable**. When the host PI line is enabled, indicates PI line status. To use the PI line, disable data bit 8, and enable the Host PI configuration option.

Note: Data bit 8 is interpreted as *either* data bit 8 or PI signal, but never both. When enabled as data bit 8, data bit 8 has priority over the PI signal, and all data above X'7F' is used to access character data and not to interpret PI line data.

Conversely, when data bit 8 is disabled and the PI signal is used, data bit 8 of the data is reserved for use as the PI function, and you cannot access characters in the X'80' - X'FF' range. Therefore, to access characters in the X'80' - X'FF' range, data bit 8 *must* be enabled.

Font Set

This parameter allows you to select a font for the Code V feature. Valid selections are 0 to 32. The following predefined values are available:

0	U.S. ASCII (the default)
1	German
2	Swedish
3	Danish
4	Norwegian
5	Finnish
6	English
7	Dutch
8	French
9	Spanish
10	Italian
11	Turkish
12	Japanese
13 — 23	Reserved
24 — 31	User Defined Sets
32	0858 PC Euro Multilingual
33	0923 Latin 9 8859-15

PI Control

Printer PI:

- **Disable** (the default). Does not inform the Code V that the ASCII emulation is configured with the PI line enabled.
- **Enable**. Informs the Code V that the ASCII emulation is configured with the PI line enabled.

Host PI:

- **Disable** (the default). The Data Bit 8 configuration option must be disabled to transmit the PI line to the printer.
- **Enable**. Informs the Code V that the host sends PI signals.

PI Slew Range: You can specify how many lines the paper will feed.

- **Enable** (the default). A paper slew of 0 — 15 will move 1 — 16 lines.
- **Disable**. A paper slew of 1 — 15 will move 1 — 15 lines. A paper slew of 0 will move 1 line.

Printer Emul Config Menu

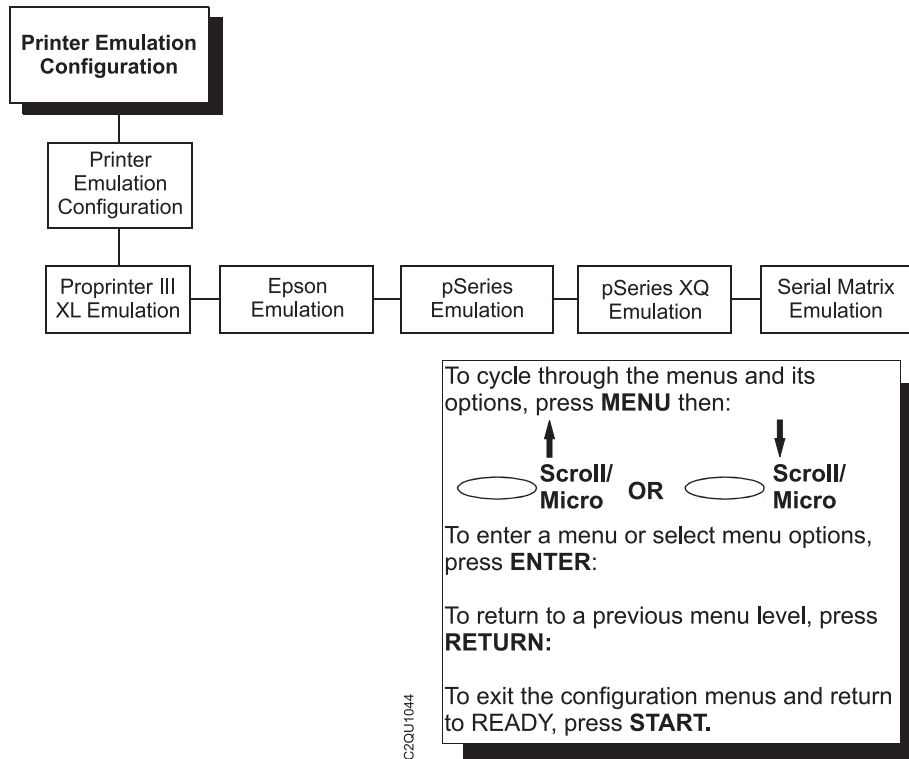

Figure 54. Printer Emulation Configuration Menu

Proprinter III XL Emulation Menu

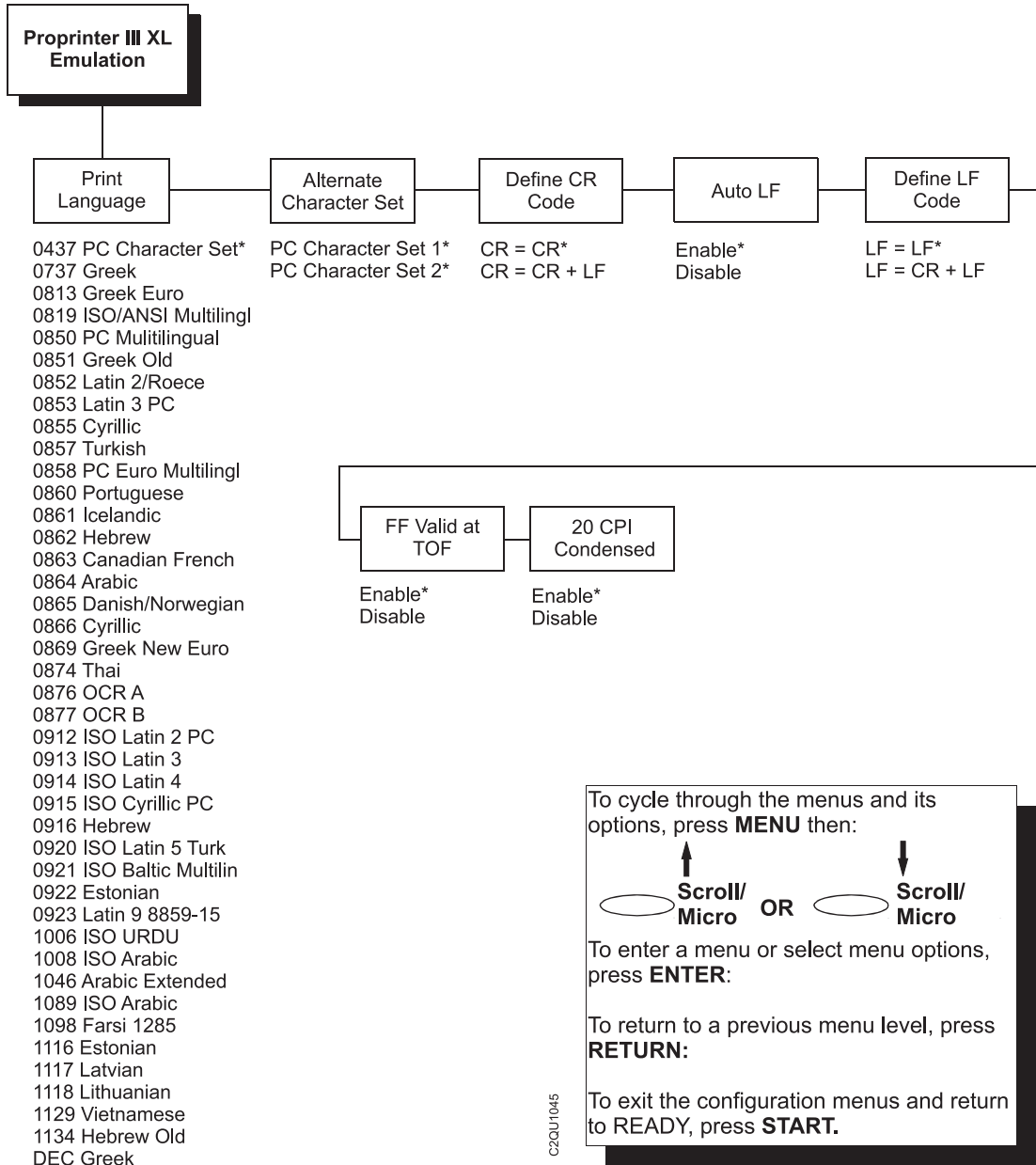

Figure 55. Proprinter III XL Emulation Menu

Print Language

Print language specifies the set of print languages used by the printer. Refer to "Proprinter III XL Emulation Menu" on page 167 for print language menus.

Alternate Character Set

The alternate character set code can be used to mix primary and alternate characters on a single line. The main character set is automatically selected when a line terminator code is received.

- **PC Character Set 1** (the default). Selects X'80' - X'9F' in the character as control codes.
- **PC Character Set 2**. Selects X'80' - X'9F' in the character as printable.

Define CR Code (Carriage Return)

This parameter forces the printer to insert an automatic Line Feed code into the data stream whenever a Carriage Return code occurs. This is to be used only if the host computer does not send Line Feeds to the printer.

- **CR = CR** (the default). Does NOT perform a line feed. The next print position will be print position 1 of the current line.
- **CR = CR + LF**. Performs an automatic line feed. The next print position will be print position 1 of the next line.

Auto LF

This parameter determines if text will wrap to the next line when the line of text exceeds the right margin.

- **Enable** (the default). Automatically inserts a CR + LF after a full print line.
- **Disable**. Truncates the text beyond the right margin until a CR or CR + LF is received.

Define LF Code (Line Feed)

This parameter forces the printer to insert an automatic Carriage Return code into the data stream whenever a Line Feed code occurs. This can be used in most installations, but it is required if the host computer does not send Carriage Returns to the printer.

- **LF = LF** (the default). Does not perform an automatic carriage return. The next print position will be the current print position of the next line.
- **LF = CR + LF**. Performs an automatic carriage return. The next print position will be print position 1 of the next line.

FF Valid At TOF

- **Enable** (the default). Performs a form feed when the host sends a Form Feed command and the printer is at the top of form.
- **Disable**. Will not perform a form feed when the host sends a Form Feed command and the printer is at the top of form.

20 CPI Condensed

Compressed print characters are narrower than the normal character set. This is helpful for applications where you need to print the maximum amount of information on a page.

- **Enable** (the default). Prints characters about 60 percent the width of normal characters when compressed print is chosen by the host computer.
- **Disable**. Does not compress print widths, even if condensed print is chosen by the host.

Epson Emulation Menu

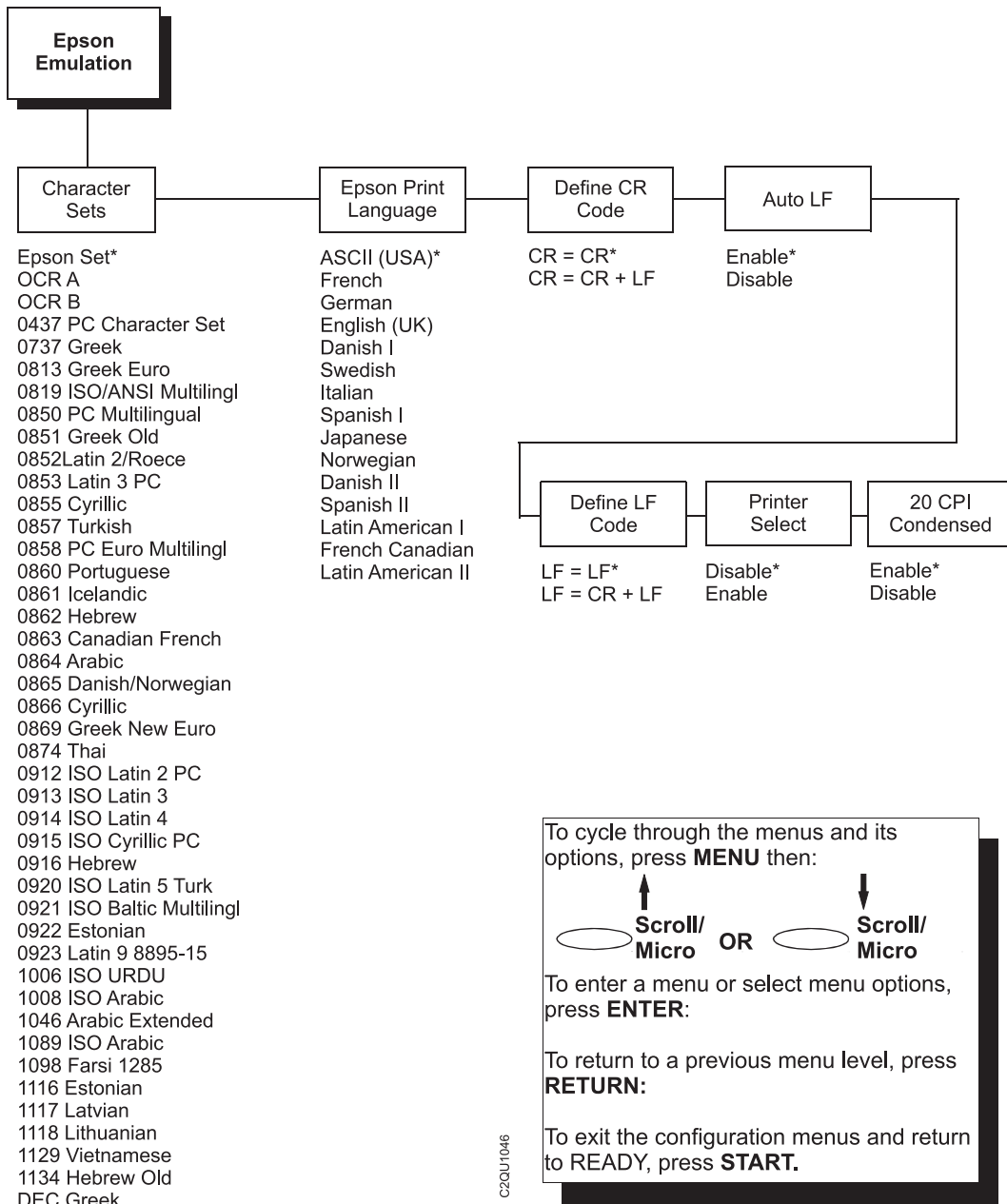

Figure 56. Epson Emulation Menu

Character Sets

This parameter selects a character set for the Epson emulation, as shown in the “Epson Emulation Menu” on page 169. To use one of these sets, choose the desired group heading (such as 0862 Hebrew) and press ENTER. Character sets are shown in detail in the *Character Sets Reference Manual*.

Epson Print Language

Epson print language specifies the set of print languages used by the printer. Refer to “Epson Emulation Menu” on page 169 for print language menus.

Define CR Code (Carriage Return)

The Define CR Code option controls the action of the printer when it receives a Carriage Return code (X'0D') from the host computer. If this feature is enabled, each time the printer receives a carriage return, it inserts an additional Line Feed code (X'0A') into the data stream. Do not use this feature if the host computer sends line feeds to the printer.

- **CR = CR** (the default). Does not insert an extra line feed after each carriage return.
- **CR = CR + LF**. Inserts an extra line feed after each carriage return.

Auto LF

This option defines the printer actions when print data is received past the forms width setting.

- **Enable** (the default). Performs an automatic carriage return and line feed when data is received past the forms width.
- **Disable**. Discards any data past the forms width.

Define LF Code (Line Feed)

The Define LF Code option controls the action of the printer when it receives a Line Feed code (X'0A') from the host computer. If this feature is enabled, each time the printer receives a Line Feed, it inserts an additional Carriage Return code (X'0D') into the data stream. This feature is required if the host computer does not send carriage returns to the printer.

- **LF = LF** (the default). Does not add a carriage return with a line feed.
- **LF = CR + LF**. Adds an extra carriage return with each line feed.

Printer Select

- **Disable** (the default). Ignores the ASCII DC1 and DC3 control codes.
- **Enable**. Disables the printer when a DC1 control code is received, and enables the printer when a DC3 control code is received.

20 CPI Condensed

Compressed print characters are narrower than the normal character set. This is helpful for applications where you need to print the maximum amount of information on a page.

- **Enable** (the default). Prints about 60 percent of the width of normal characters when compressed print is chosen by the host computer. For example, a 12 CPI Draft font will compress to 20 CPI.
- **Disable**. Does not compress print widths, even if condensed print is chosen by the host.

pSeries Emulation Menu

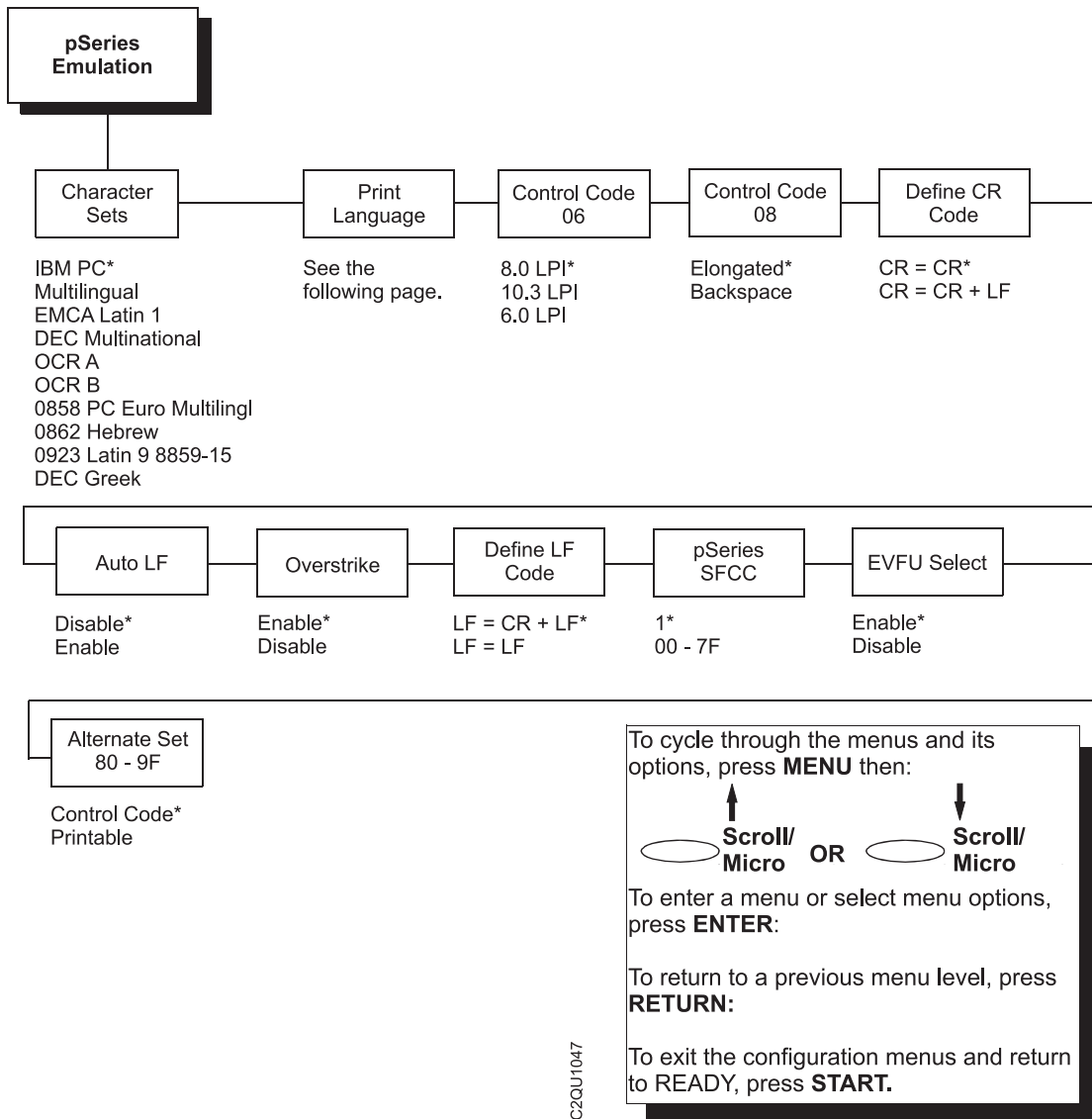

Figure 57. pSeries Emulation Menu

Print Language

IBM PC

- Select Subset Primary
 - ASCII (USA)*
 - French
 - German
 - English (UK)
 - Danish
 - Swedish
 - Italian
 - Spanish
 - Japanese
 - French Canadian
 - Latin American
 - Danish II
 - Spanish II
 - Latin American II
- Select Subset Extended
 - 0437 PC Character Set*
 - 0850 PC Multilingual

Multinational

- ASCII (USA)*
- EBCDIC

EMCA Latin 1

- Select Subset Primary
 - ASCII (USA)*
 - German
 - Swedish
 - Danish
 - Norwegian
 - Finnish
 - English (UK)
 - Dutch
 - French
 - Spanish
 - Italian
 - Turkish
 - Japanese
- Selected Subset Extended
 - Multinational*
 - Barcode 10 CPI
 - Multinational CP 10 CPI
 - Multinational CP 12 CPI
 - Multinatl NLQ 10 CPI
 - Greek DP 10 CPI
 - Greek DP 12 CPI
 - Greek NLQ 10 CPI
 - Graphic DP 10 CPI
 - Graphic NLQ 10 CPI
 - Scientific DP 10 CPI
 - Scientific DP 12 CPI
 - Scientific NLQ 10 CPI

DEC Multinational

- ASCII (USA)*
- French
- German
- English (UK)
- Norwegian/Danish
- Swedish
- Italian
- Spanish
- Japanese
- French Canadian
- Dutch
- Finnish
- Swiss

C10U1048

Figure 58. pSeries Emulation Menu - Print Language

Character Sets

Specifies a character set as shown in the “pSeries Emulation Menu” on page 171. To use one of these sets, choose the desired group heading (such as 0862 Hebrew) and press **ENTER**.

Print Language

Print language specifies the set of print languages used by the printer. Refer to the previous page for print language menus.

Control Code 06

Control Code 06 defines the function of ASCII code X'06' (ACK). You can select an alternate line spacing of:

- **8.0 LPI** (the default)
- **10.3 LPI**
- **6.0 LPI**

Control Code 08

Control Code 08 defines the function of ASCII code X'08' (BS). You can define the code to output the following character:

- **Elongated** (the default)
- **Backspace**

Define CR Code (Carriage Return)

This option controls the action of the printer when it receives a Carriage Return code (X'0D') from the host computer. If this feature is enabled, each time the printer receives a carriage return, it inserts an additional Line Feed code (X'0A') into the data stream. Do not use this feature if the host computer sends Line feeds to the printer.

- **CR = CR** (the default). Does not insert an extra line feed after each carriage return.
- **CR = CR + LF**. Inserts an extra line feed after each carriage return. The next print position will be print position 1 of the next line.

Auto LF

This option defines the printer action when print data is received past the forms width setting.

- **Disable** (the default). Discards any data past the forms width.
- **Enable**. Performs an automatic carriage return and line feed when data is received past the forms width, causing the excess text to print on the next line.

Overstrike

This option enables you to print bold characters.

- **Enable** (the default). Turns on bold print. When enabled, overstrike printing slows down the printer.
- **Disable**. Turns off bold print.

Define LF Code

- **LF = CR + LF** (the default). Forces an automatic carriage return with each line feed command. The next print position is print position 1 of the next line.
- **LF = LF**. Does not perform an automatic carriage return. The next print position will be the current print position of the next line.

pSeries SFCC

This parameter allows you to select which ASCII codes will function as the Special Function Control Code (SFCC) command delimiter. pSeries codes can use X'00' through X'7F'. Options include the following:

- **SOH (X'01')** (the default.)
- **ESC (X'1B')**
- **ETX (X'03')**
- **CIRCUMFLEX (X'5E')** - also called caret (^)
- **TILDE (X'7E')** - (~)

Note: SOH, ETX, and ESC are non-printables. The characters (^) and (~) are printable; however, do not use them as printables in the host data stream if either is chosen as a delimiter because print errors will occur.

EVFU Select

The EVFU SELECT (Electronic Vertical Format Unit Select) option determines if EVFU skips can be defined. An EVFU skip is an instruction to move the paper to a specific location on a form. See the *InfoPrint 6500 ASCII Programmer's Reference Manual* for more information.

- **Enable** (the default). Defines EVFU skips.
- **Disable**. Does not define EVFU skips.

Alternate Set 80-9F

- **Control Code** (the default). Interprets data in the range of X'80' through X'9F' as a control code.
- **Printable**. Prints data in the range of X'80' through X'9F'.

pSeries XQ Emulation Menu

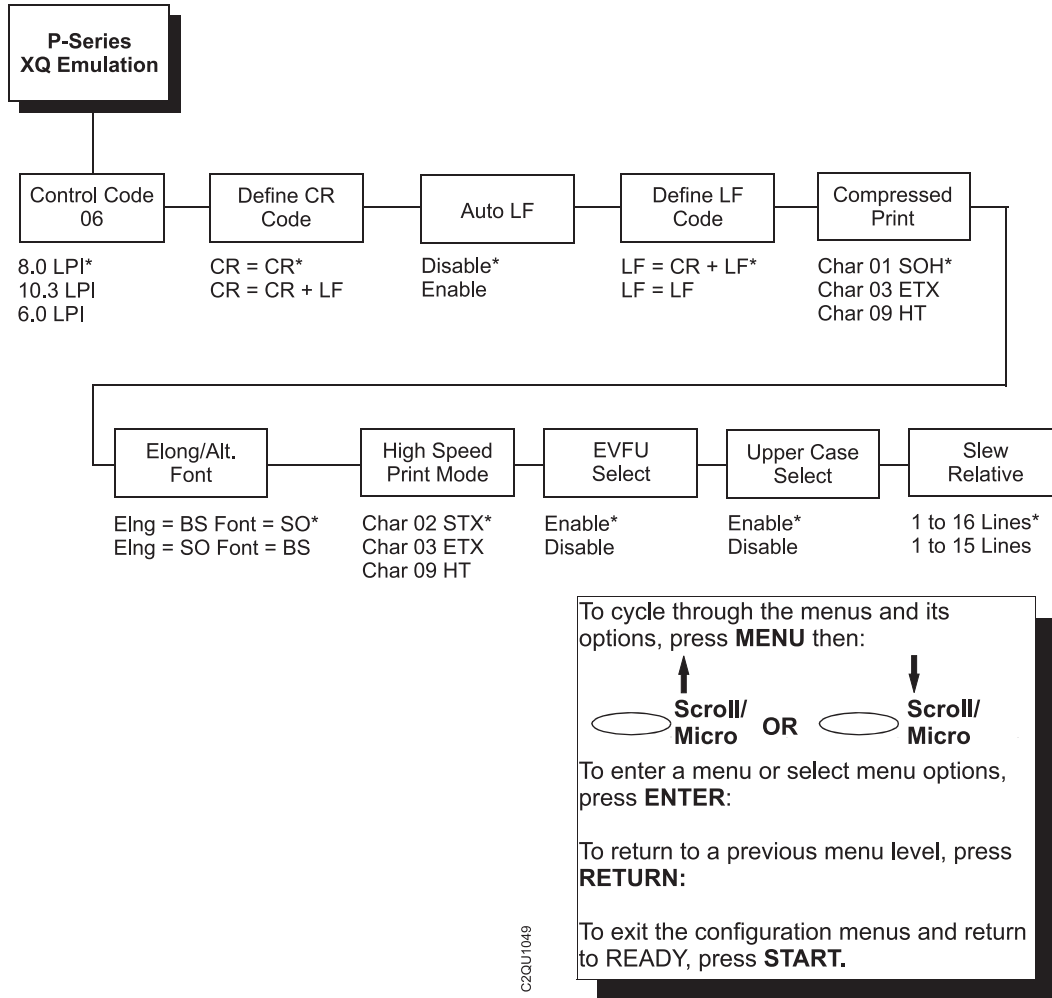

Figure 59. pSeries XQ Emulation Menu

Control Code 06

Control Code 06 defines the function of ASCII code X'06' (ACK). You can select an alternate line spacing of:

- 8.0 LPI (the default).
- 10.3 LPI
- 6.0 LPI

Define CR Code (Carriage Return)

This option controls the action of the printer when it receives a Carriage Return code (X'0D') from the host computer. If this feature is enabled, each time the printer receives a Carriage Return, it inserts an additional Line Feed code (X'0A') into the data stream. Do not use this feature if the host computer sends line feeds to the printer.

- **CR = CR** (the default). Does not insert an extra line feed after each carriage return.
- **CR = CR + LF**. Inserts an extra line feed after each carriage return. The next print position will be print position 1 of the next line.

Auto LF

This option defines the printer action when print data is received past the forms width setting.

- **Disable** (the default). Discards any data past the forms width.
- **Enable**. Performs an automatic carriage return and line feed when data is received past the forms width.

Define LF Code (Line Feed)

- **LF = CR + LF** (the default). Forces an automatic carriage return with each line feed command received. The next print position is print position 1 of the next line.
- **LF = LF**. Does not perform an automatic carriage return when a line feed command is received. The next print position will be the current print position of the next line.

Compressed Print

Controls which host command sets compressed printing.

- **Char 01 SOH** (the default)
- **Char 03 ETX**
- **Char 09 HT**

Elong/Alt. Font

Controls which host command sets elongated (double high) fonts and extended character set.

- **EIng=BS Font=SO** (the default)
- **EIng=SO Font=BS**

High Speed Print Mode

Controls which host command sets high speed printing.

- **Char 02 STX** (the default)
- **Char 03 ETX**
- **Char 09 HT**

EVFU Select

The EVFU SELECT (Electronic Vertical Format Unit Select) option determines if EVFU skips can be defined. An EVFU skip is an instruction to move the paper to a specific location on a form. See the *InfoPrint 6500 ASCII Programmer's Reference Manual* for more information.

- **Enable** (the default). Defines EVFU skips.
- **Disable**. Does not define EVFU skips.

Upper Case Select

Controls how the printer handles lowercase characters it receives from the host computer. When enabled, all characters will be printed in uppercase.

- **Disable** (the default). Prints lowercase characters received from the host computer as lowercase, and prints uppercase characters received from the computer as uppercase.
- **Enable**. Prints lowercase characters received from the host computer as their corresponding uppercase equivalents; uppercase characters received from the computer print as uppercase.

Slew Relative

“Slewing” is rapid vertical paper movement. This parameter determines the number of lines slewed when an EVFU Slew Relative command is received.

- **1-16 Lines** (the default). Slews 1-15 lines.
- **1-16 Lines**. Slews 1-16 lines.

Serial Matrix Emulation Menu

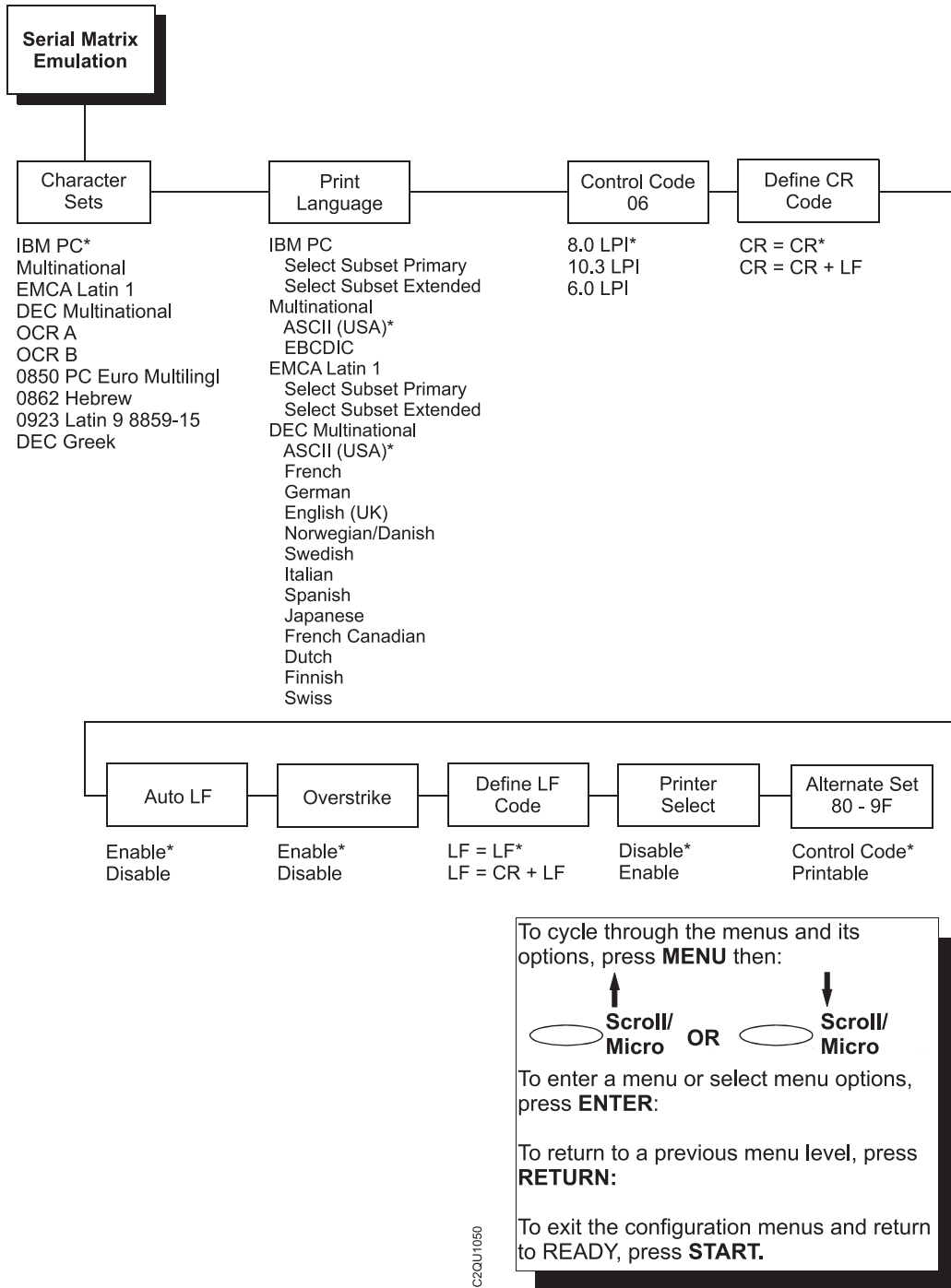

Figure 60. Serial Matrix Emulation Menu

Character Sets

Specifies a character set as shown above. To use one of these sets, choose the desired group heading (such as 0862 Hebrew) and press ENTER.

- **IBM PC** (the default)
- **Multinational**
- **EMCA Latin 1**
- **DEC Multinational**
- **OCR A**
- **OCR B**
- **0858 PC Euro Multilingual**
- **0862 Hebrew**
- **0923 Latin 9 8859-15**
- **DEC Greek**

Print Language

Print language specifies the set of print languages used by the printer.

- **IBM PC** (the default)
- **Multinational**
- **EMCA Latin 1**
- **DEC Multinational**

Control Code 06

Control Code 06 defines the function of ASCII code X'06' (ACK).

- **8.0 LPI** (the default)
- **10.3 LPI**
- **6.0 LPI**

Define CR Code (Carriage Return)

This option controls the action of the printer when it receives a Carriage Return code (X'0D') from the host computer. If this feature is enabled, each time the printer receives a Carriage Return, it inserts an additional Line Feed code (X'0A') into the data stream. Do not use this feature if the host computer sends line feeds to the printer.

- **CR = CR** (the default). Does not insert an extra line feed after each carriage return.
- **CR = CR + LF**. Inserts an extra line feed after each carriage return. The next print position will be print position 1 of the next line.

Auto LF

The Auto LF option defines the printer action when print data is received past the forms width setting.

- **Enable** (the default). Performs an automatic carriage return and line feed when data is received past the forms width.
- **Disable**. Discards any data past the forms width.

Overstrike

This option enables you to print bold characters.

- **Enable** (the default). Turns on bold print. When enabled, overstrike printing slows down the printer.
- **Disable**. Turns off bold print.

Define LF Code (Line Feed)

- **LF = LF** (the default). Does not perform an automatic carriage return when a line feed command is received. The next print position will be the current print position of the next line.
- **LF = CR + LF**. Forces an automatic carriage return with each line feed command received. The next print position is print position 1 of the next line.

Printer Select

- **Disable** (the default). Ignores the ASCII DC1 and DC3 control codes.
- **Enable**. Disables the printer when a DC1 control code is received, and enables the printer when a DC3 control code is received.

Alternate Set 80-9F

- **Control Code** (the default). Interprets data in the range of X'80' through X'9F' as a control code.
- **Printable**. Prints data in the range of X'80' through X'9F'.

Print Format Menu

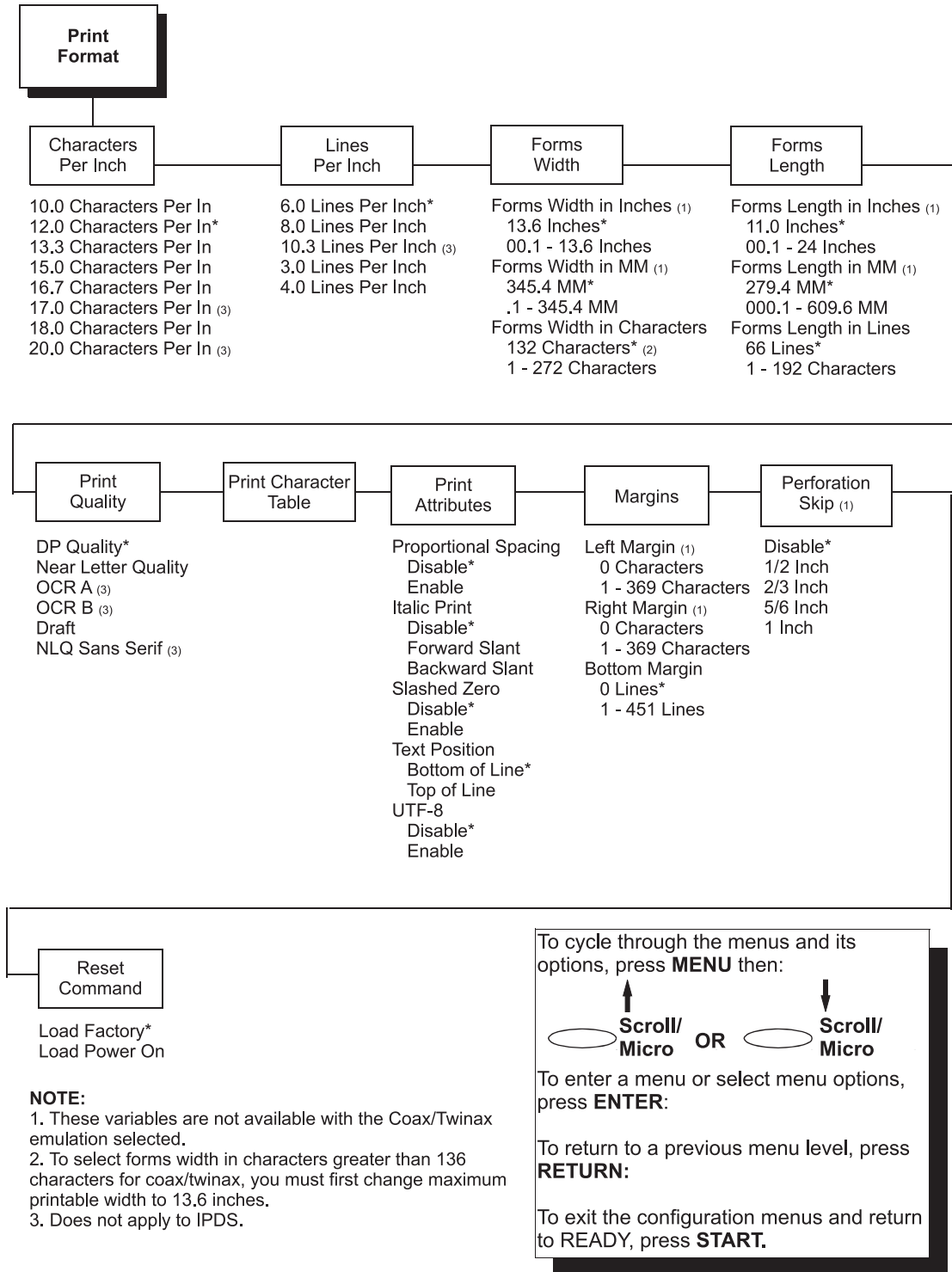

Figure 61. Print Format Menu

Characters Per Inch

CHARACTERS PER INCH (CPI) specifies the number of characters that will print per horizontal inch.

- **10.0 Characters Per In** (the default)
- **12.0 Characters Per In**
- **13.3 Characters Per In**
- **15.0 Characters Per In**
- **16.7 Characters Per In**
- **17.1 Characters Per In**
- **18.0 Characters Per In**
- **20.0 Characters Per In**

It is possible to specify a CPI value that causes the page width to exceed the maximum physical page width. In this case, the printer automatically changes the page width to the highest valid value for the new CPI.

When OCR A or OCR B is selected as the default print language, 10 CPI is the only available value for this parameter. If a different CPI value is desired, the print language must be changed first.

Note: Receipt of a data stream control code that specifies a CPI value overrides any value entered via the operator panel.

Lines Per Inch

LINES PER INCH (LPI) specifies the number of lines that will print per vertical inch.

- **6.0 Lines Per Inch** (the default)
- **8.0 Lines Per Inch**
- **10.3 Lines Per Inch**
- **3.0 Lines Per Inch**
- **4.0 Lines Per Inch**

It is possible to specify an LPI value that causes the page length to exceed the maximum allowed page length. In this case, the printer automatically changes the page length to the highest valid value for the new LPI.

Note: Receipt of a data stream control that specifies the LPI value overrides the value entered via the operator panel.

Forms Width

FORMS WIDTH specifies the forms width in inches, millimeters or characters. All three measurements will update the same configuration parameter. The default values for forms width are 13.6 inches, 345.4 mm and 136 characters.

Note: The default values for forms width are 13.2 inches, 335.5 mm and 132 characters when pSeries, Coax/Twinax, IGP, Code V, or IPDS are installed.

FORMS WIDTH IN INCHES and FORMS WIDTH IN MM selections are not available with the Coax/Twinax or IPDS emulation. The only variable available with the Coax/Twinax and IPDS emulation is FORMS WIDTH IN CHARACTERS.

Descriptions follow for the three ways of specifying the forms width:

Forms Width In Inches: Allows you to input the forms width in inches. Valid values range from 00.1 through 13.6 inches, in increments of 0.1 inch.

Forms Width In MM: Allows you to input the forms width in millimeters. Valid values range from .1 through 345.4, in increments of tenths of a millimeter (0.1 mm).

Forms Width In Characters: Allows you to input the forms width in characters. The maximum forms width in characters depends on the current CPI setting; it is equal to the maximum forms width in inches multiplied by the current CPI setting.

For example, at 10 CPI, the maximum forms width is:

10 CPI x 13.6 inches = 136 characters.

Only valid forms width values will be accepted. If a width is selected that is larger than the maximum width for the current CPI, then the maximum width will be used. If a larger width value is desired, then the CPI value must be changed first.

Note: To select forms width in characters greater than 132 characters for Coax/Twinax, you must first change maximum printable width to 13.6 inches.

Receipt of a data stream control code that changes the page width overrides the page width previously specified via the operator panel.

The following table lists the maximum number of characters that can be printed for a given Characters Per Inch (CPI) setting.

Table 4. CPI Settings

CPI Setting	Maximum Forms Width (in Characters)
10.0	136*
12.0	163
13.3	181
15.0	204
16.7	227
17.1	232
18.0	245
20.0	272
* = Default	

IMPORTANT: If the forms width is set in characters and the CPI is changed, the effective page width is changed to be equal to the forms width in characters divided by the new CPI. For example, if the current forms width is 132 characters and the CPI is changed from 10 CPI to 15 CPI, the effective forms width changes from 13.2 inches to 8.8 inches.

Note: This applies only if the forms width is set in characters. If the forms width is set in inches or millimeters (mm), changing the CPI does not affect the effective forms width.

Forms Length

FORMS LENGTH specifies the forms length in inches, millimeters or lines. All three measurements will update the same configuration parameter. The default values for forms length are 11 inches, 279.4 millimeters, or 66 lines per page.

Descriptions follow for the three ways of specifying the forms length:

Note: The actual value displayed for forms length set in inches and mm can be greater than the maximum values listed on the operator panel because the number of lines can exceed actual inches and mm values.

FORMS LENGTH IN INCHES and FORMS LENGTH IN MM selections are not available with the Coax/Twinax or IPDS emulations. The only variable available with the Coax/Twinax and IPDS emulations is FORMS LENGTH IN LINES.

Forms Length In Inches: Allows you to input the forms length in inches. Valid values range from 00.1 through 24 inches, in increments of 0.1 inch. (This option not available for the Coax interface.)

Forms Length In MM: Allows you to input the forms length in millimeters. Valid values range from 000.1 through 609.6 millimeters, in increments of tenths of a millimeter (0.1 mm). (This option not available for the Coax interface.)

Forms Length In Lines: Allows you to input the forms length in lines. The maximum forms length in lines depends on the current LPI setting; it is equal to the maximum forms length in inches multiplied by the current LPI setting.

For example, at 6 LPI the maximum forms length is:

6 LPI x 24 inches = 144 lines

Only valid forms length values will be accepted. If you select a length that is larger than the maximum length for the current LPI, the maximum length will be used. If you need a longer page length, you must first change the LPI.

IMPORTANT: If the forms length is set in lines and you change the LPI, the effective page length changes to the forms length in characters divided by the new LPI. For example, if the current forms length is 66 lines and you change the LPI from 6 LPI to 8 LPI, then the effective forms length changes from 11 inches to 8.25 inches.

Note: This only applies if the forms length is set in lines. If the forms length is set in inches or millimeters, changing the LPI does not affect the effective forms length.

Receipt of a data stream control code which changes the forms length overrides the forms length previously specified via the operator panel.

Print Quality

Note: When using bold or emphasized printing, the printer prints two dots instead of one to produce the desired effect. This does not affect characters per inch.

This parameter specifies the density (quality) of printing:

- **DP Quality** (the default)
- **Near Letter Quality**
- **OCR A**
- **OCR B**
- **Draft**
- **NLQ Sans Serif**

Note: Receipt of a data stream control sequence that changes the print quality overrides the print quality specified via the operator panel.

Specifying a print *quality* of OCR A or OCR B will change the print language to OCR A or OCR B.

When OCR A or OCR B is selected as the default print language, OCR A/OCR B are the only available values for this parameter. If a different print quality value is desired, the print language must be changed first.

Print Character Table

This parameter prints out a table of the current interface character set.

Print Attributes

The PRINT ATTRIBUTES parameter is used to determine character and page formatting.

Proportional Spacing: Uses proportional spacing for text data when enabled.

- **Disable** (the default)
- **Enable.** Uses proportional spacing for text data.

Note: Proportional spacing is only supported in 10 CPI. Therefore, you must select 10 CPI, or proportional spacing will be ignored.

Italic Print: Prints text in italics, when enabled. Both a forward and backwards slanting italic are available.

Disable (the default)

Forward Slant. Uses italic print that slants forward.

Backward Slant. Uses italic print that slants backward.

Slashed Zero: Prints zeros with a slash, when enabled, to distinguish zeros from the alphabetic capital "O".

- **Disable** (the default)
- **Enable.** Prints zeros with a slash.

Text Position: Specifies where the text will be positioned in the line space. When set to Top of Line, text will be positioned at the top of the line space. When set to Bottom of Line, the text will be positioned as if it were at the bottom of a 6 lpi line space.

Bottom Of Line (the default)

Top of Line

The following example shows both Top of Line and Bottom of Line text positions for a 6 LPI line spacing:

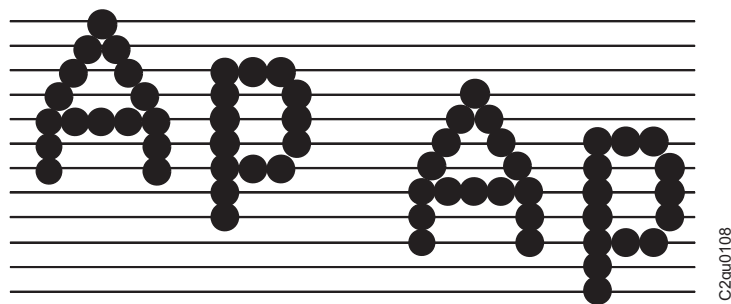

Figure 62. Top of Line and Bottom of Line Text Positions

UTF-8:

- **Disable** (the default).
- **Enable.** Selects the UTF-8 character set (Unicode encoded font).

Margins

Note: LEFT MARGIN and RIGHT MARGIN selections are not available with the Coax/Twinax emulation. The only variable available with the Coax/Twinax emulation is BOTTOM MARGIN.

The MARGINS parameter defines where the bottom, left, and right page margins are located.

Left Margin: Defines where print position 1 is located. The left margin is specified as the number of characters from the left edge of the forms. Valid values range from the following:

- **0 Characters** (the default)
- **0 - 369 Characters**

Right Margin: Defines where the last print position is located. The right margin is specified as the number of characters from the right edge of the forms. Valid values range from the following:

- **0 Characters** (the default)
- **0 - 369 Characters**

Bottom Margin: Defines the location of the last print line on the page. The bottom margin is specified as the number of lines from the bottom of forms position. Valid values range from the following:

- **0 Lines** (the default)
- **0 - 451 Lines**

Perforation Skip

- **Disable.** (The default) Allows printing on page perforation.
- **1/2 inch.** Allows you to set up a skip-over margin of $\frac{1}{2}$ inch. For example, a skip-over margin of $\frac{1}{2}$ inch allows a $\frac{1}{2}$ inch margin at the bottom of the page.
- **2/3 inch.** Allows you to set up a skip-over margin of $\frac{2}{3}$ inch.
- **5/6 inch.** Allows you to set up a skip-over margin of $\frac{5}{6}$ inch.
- **1 inch.** Allow you to set up a skip-over margin of 1 inch.

Reset Command

Reset Command specifies the configuration that will be used by the printer after the reset command is issued.

- **Load Factory** (the default). Loads the factory default configuration for printer use. This is the default selection.
- **Load Power On.** Loads the selected power on configuration for printer use.

Operator Print Tests Menu

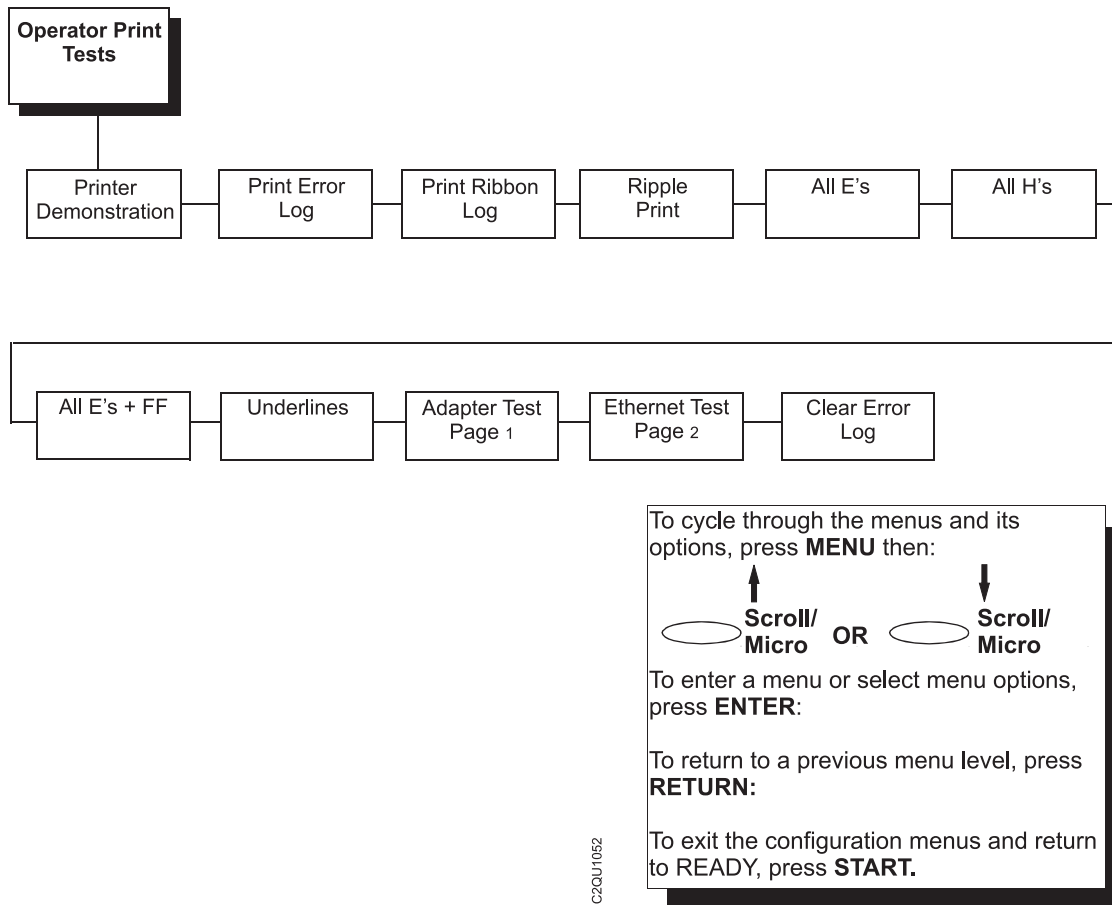

Notes:

1. The Adapter Test Page is only available with the Ethernet Adapter feature installed.
2. The Ethernet Test Page is only available with the Integrated Ethernet feature installed.

Figure 63. Operator Print Tests Menu

The print tests are used to check the print quality and operation of your printer. The procedure to run these tests is shown on page 216. The self-tests include the following:

Printer Demonstration

(The default). Demonstrates some of the functions and features available on the printer.

Print Error Log

Prints a log of errors that have occurred in the printer.

Print Ribbon Log

Prints a log of 100 previously depleted ribbons and identifies them should they be reinstalled on the same printer.

Ripple Print

A “sliding” alphanumeric pattern used to identify missing or malformed characters, improper vertical alignment, or vertical compression.

All E's

A pattern of all uppercase E's that identifies missing characters, misplaced dots, smeared characters, improper phasing problems, or light/dark character variations.

All H's

A pattern of all uppercase H's used to detect missing characters, misplaced dots, smeared characters, or improper phasing.

All E's + FF

A pattern of all E's repeated for ten lines and followed by a form feed to the next page top-of-form, used to identify paper motion or feeding problems, such as paper path obstruction or improper forms.

Underlines

An underline pattern useful for identifying hammer bank misalignment.

Adapter Test Page

Prints an Ethernet Adapter configuration page. If the Ethernet Adapter is not properly installed, this page will not print.

Note: This page contains important system and Ethernet adapter information and should be maintained with your system configuration printout.

Your InfoPrint Solutions Company Customer Service Representative will typically run these tests.

Ethernet Test Page

Prints an Ethernet configuration page. If the Integrated Ethernet is not properly installed, this page will not print.

Note: This page contains important system and Ethernet information and should be maintained with your system configuration printout.

Your InfoPrint Solutions Company Customer Service Representative will typically run these tests.

Clear Error Log

Clears entries in the error log.

Printer Information Menu

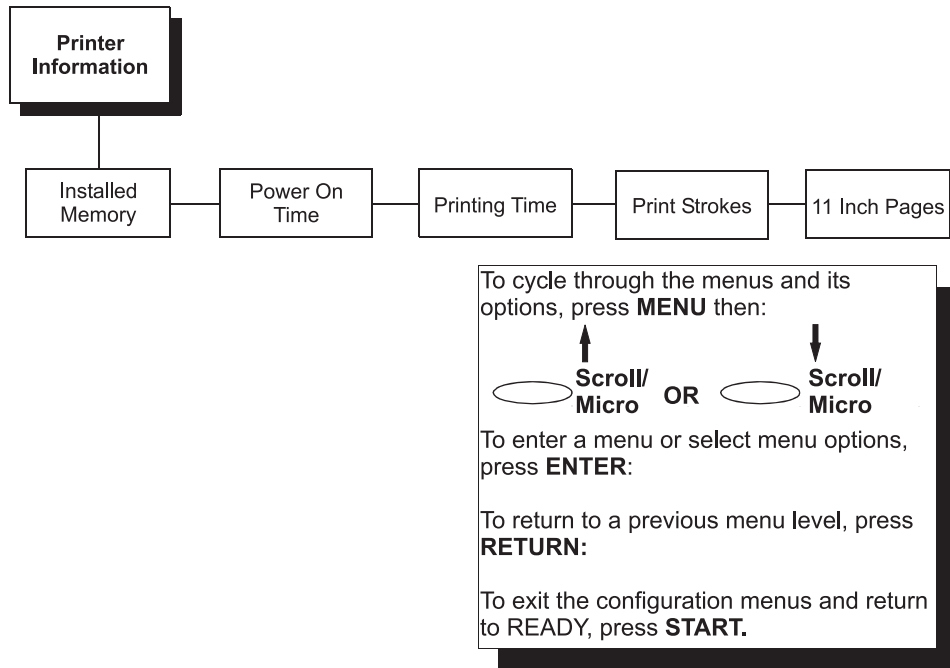

Figure 64. Printer Information Menu

You can view various printer statistics, such as hours of usage, and refer to these figures for preventive maintenance purposes. Printer statistics accumulate continuously; they do not reset when you power off the printer.

All of the printer statistics are set to zero at the factory after burn-in testing.

Installed Memory

Displays the amount of RAM installed in the printer in megabytes.

Power On Time

The cumulative time in hours the printer has been powered on. The range is 0 through 30,000 hours.

Printing Time

The cumulative time in hours the printer has actually been printing. The range is 0 through 30,000 hours.

Print Strokes

The cumulative number of back-and-forth shuttle strokes the printer has printed during normal operation. The range is 0 through 4,000,000,000 shuttle strokes.

11 Inch Pages

The cumulative number of pages the printer has printed. The range is 0 through 363,000,000 pages.

Chapter 5. Printer Interfaces

Overview

This section describes the host interfaces provided with the printer. The printer interface is the point where the data line from the host computer plugs into the printer. The interface processes all communications signals and data to and from the host computer. The printer interface consists of a printed circuit board assembly (PCBA) and a cable connector for the data line. Communication signals and data may be sent over parallel or serial lines.

Each InfoPrint 6500 printer is equipped with three parallel interface protocols and two serial interface protocols. Coax and Twinax interface protocols are available as optional features. Each interface is selected via the operator panel configuration menu. See Chapter 3, "Configuring the Printer," on page 19.

The Ethernet interface is also an optional feature. Refer to the *Ethernet Interface User's Manual* for more information.

This section describes the interfaces provided with the printer. In addition, instructions are provided for configuration of terminating resistors.

- Coax / Twinax
- RS-232 serial
- RS-422 serial (optional for the 6500-v20 models)
- PC Parallel
- Dataproducts parallel
- IEEE1284
- Ethernet 10/100Base-T

RS-232 and RS-422 Serial Interfaces

Note: The RS-232 and RS-422 serial interface circuit characteristics are compatible with the Electronic Industry Association Specifications EIA-232-E and EIA-422-B.

The RS-232 and RS-422 serial interfaces enable the printer to operate with bit serial devices that are compatible with an RS-232 controller. The input serial data transfer rate (in baud) is selectable from the printer's control panel. Baud rates of 600, 1200, 2400, 4800, 9600, 19200, 38400, 57600, and 115200 baud rates are available.

Note: If you select a baud rate that is greater than 19200, you may need to use RS-422 to prevent data loss. You may also need to increase the Buffer Size in K parameter from the default (1 Kbyte) to improve performance.

The input format consists of a single start bit, 7 or 8 data bits, and one or two stop bits. The number of data bits is determined by printer configuration. The data bits are interpreted with the least significant bit first. Parity checking is determined by printer configuration options selected from the operator panel.

The printer interface uses a first-in/first-out buffer. The asynchronous interface accepts data as it is provided by the host. The length of the data cable from the host computer to the printer must not exceed 50 feet (15 meters) for RS-232 interfaces and 4000 feet (1220 meters) for RS-422 interfaces. (A copper conductor, twisted-pair telephone cable with a shunt capacitance of 16 pF/foot [52.5 pF/meter] terminated in a 100 ohm resistive load must be used for the RS-422.)

RS-232

6500-v20 Models

Table 5. 6500-v20 RS-232 Serial Interface Connector Pin Assignments

Input Signals		Output Signals		Miscellaneous	
Signal	Pin	Signal	Pin	Signal	Pin
Receive Data (RXD)	2	Transmit Data (TXD)	3	Chassis/Signal Ground	5
Clear to Send (CTS)	8	Request to Send (RTS)	7		
Data Set Ready (DSR)	6	Data Terminal Ready (DTR)	4		
Data Carrier Detect (DCD)	1				

Receive Data (RXD). Serial data stream to the printer.

Clear To Send (CTS). Status signal to the printer indicating the host is ready to receive data/status signals from the printer.

Data Set Ready (DSR). Status signal to the printer indicating the host is in a ready condition.

Data Carrier Detect (DCD). Status signal to the printer. The ON condition is required for the printer to receive data.

Transmit Data (TXD). Serial data stream from the printer for transmitting status and control information to the host. Subject to protocol selection.

Request To Send (RTS). Control signal from the printer. Subject to configuration.

Data Terminal Ready (DTR). Control signal from the printer. Subject to configuration.

RS-422

6500 Models

Note: The RS-422 is optional.

Table 6. RS-422 Serial Interface Connector Pin Assignments

Input Signals		Output Signals		Miscellaneous	
Signal	Pin	Signal	Pin	Signal	Pin
- Receive Data (-RXD)	1	- Transmit Data (-TXD)	3	Chassis/Signal Ground	5
+ Receive Data (+RXD)	6	+ Transmit Data (+TXD)	8		

+RXD, -RXD. Serial data stream differentially received by printer.

+TXD, -TXD. Differentially driven serial data stream for transmitting status and control information to the host. Subject to protocol selection.

Note: \pm RXD and \pm TXD form signal and return paths of a differential line signal.

RS-232 Serial Interface Protocols

DTR. (DTE Ready). The printer controls the data flow by asserting or de-asserting this hardware signal to the host. If there is enough room in the printer buffer, the printer will send a high signal; if the buffer is full the printer will send a low signal. DTR tells the host if it is safe to send more data (If the host sends data during an unsafe condition, data will be lost.)

RS-232 and RS-422 Serial Interface Protocols

X-ON / X-OFF. Transmit On/Transmit Off. The printer transmits an X-ON character (hex 11) when entering the Ready mode or when the buffer is almost empty. The printer transmits an X-OFF character (hex 13) when entering the Not Ready mode or when the buffer is almost full.

ETX / ACK. End of Text/Acknowledge. This host controls the flow of communication to the printer by sending a block of data and ending the block with an End of Text (ETX) signal. When the printer receives the ETX signal, it will acknowledge it has received the entire block of data.

ACK / NAK. Acknowledge/Negative Acknowledge. ACK means acknowledge; the device acknowledges it has accepted a transmission. NAK means a negative acknowledge; the device did not receive the transmission.

RS-232 and RS-422 Serial Interface Error Handling

Note: All serial errors are treated as faults that require operator intervention.

Parity Error Handling. Parity error checking is a configuration option selected from the operator panel.

With odd or even parity checking selected, a character with a parity error is replaced with a question mark (?) character.

When parity checking is not selected ("NONE" on the operator panel), parity errors are ignored and the characters are printed as received.

Framing Error Handling. Framing error checking is always in effect for the serial interface.

When a framing error occurs, an exclamation point (!) is printed. If 20 successive errors are received, a line feed is added to force printing to occur.

Overrun Error Handling. Overrun error checking is always in effect for the serial interface.

When a data overrun error occurs, an asterisk (*) is printed. If 20 successive errors are received, a line feed is added to force printing to occur.

RS-232 and RS-422 Serial Interface Configuration

Your printer is configured as the factory to match the interface you specified. By using the operator panel, you may verify and change several interface parameters to meet specific application requirements.

Refer to “RS-232 and RS-422 Serial Interfaces” on page 194 for RS-232 and RS-422 parameter descriptions and information for selecting values for the following parameters:

RS-232 and RS-422:

- Baud rate (data rate selected from the operator panel)
- Data Bits (7 or 8 Bits)
- Stop Bits (1 or 2 Bits)
- Parity (None, Odd, Even, Mark, or Sense)

RS-232 only:

- Data Terminal Ready logic
- Request to Send logic

Some application programs require a unique configuration. If the printer is not working properly in the configuration you selected, contact an InfoPrint Solutions Company service representative.

One Char Enquiry

When enabled, and the IGP feature is available, a status byte is sent back to the host when the poll character or the command SFCC enquiry is sent to the printer (serial interface only). The poll character is received and the status byte is sent whether the printer is online or offline. The SFCC enquiry will only be processed when the printer is online.

Poll Character

This option is used when One Char Enquiry is enabled and the IGP feature is available. Whenever the printer receives this character, it sends a response to the host indicating the current state of the printer. It may be configured from 0 through 255. The default value is 0.

PC Parallel Interface

The PC Parallel interface (also referred to as the “Centronics” interface) enables the printer to operate with controllers designed for buffered PC Parallel printers. The length of the data cable from the host computer to the printer must not exceed 15 feet (5 meters).

Note: For a more detailed reliable data transfer, a maximum cable length of six feet is recommended.

Table 7. Printer PC Parallel Interface Connector Pin Assignments

Input Signals		Output Signals		Miscellaneous	
Signal	Pin	Signal	Pin	Signal	Pin
DATA LINE 1	2	ACKNOWLEDGE	10	CHASSIS GROUND	17
Return	20	Return	28		
DATA LINE 2	3	ONLINE/SELECT	13	GROUND (GND)	16, 30
Return	21	FAULT	32		
DATA LINE 3	4	FAULT	32	(NC)	34
Return	22	Return	29		
DATA LINE 4	5	PAPER EMPTY	12		
Return	23	Return	30		
DATA LINE 5	6	BUSY	11		
Return	24	Return	29		
DATA LINE 6	7	NAUTO FEED	14		
Return	25				
DATA LINE 7	8	NINIT (PRIME)	31		
Return	26				
DATA LINE 8	9	NOT	35		
Return	27	DATAPRODUCTS*			
DATA STROBE	1	EXTERNAL 5 VOLTS	18		
Return	19				
PAPER INSTRUCTION	15	N SELECT	36		
Return	33				

PC Parallel Interface Signals

Data Lines 1 through 8. Provides eight standard or inverted levels from the host that specify character data, plot data, or a control code. Data Line 8 allows access to the extended ASCII character set. You may enable or disable this line via the Data Bit 8 parameter on the Centronics submenu.

Data Strobe. Carries a low true, 100 ns minimum pulse from the host that clocks data into the printer.

Paper Instruction (PI). Carries a CVFU signal from the host with the same timing and polarity as the data line.

Acknowledge. A low true pulse from the printer indicating the character or function code has been received and the printer is ready for the next data transfer.

Online/Select. A high true level from the printer to indicate the printer is ready for data transfer and the **START** key on the operator panel has been activated. When the printer is in Ready mode, it may accept data from the host.

Paper Empty (PE). A high true level from the printer to indicate the printer is in a paper empty or paper jam fault.

Busy. A high true level from the printer to indicate the printer cannot receive data.

PC Parallel Interface Configuration

Your printer is configured at the factory to match the interface you specified. By using the operator panel, you may verify and change several interface parameters to meet specific application requirements.

Refer to “PC Parallel Menu” on page 119 for PC Parallel parameter descriptions and information on selecting values for the following parameters:

- Data Bit 8 (enable or disable)
- Data Polarity (standard or inverted)
- Strobe Polarity (standard or inverted)
- Response Polarity (standard or inverted)
- Busy on Strobe (enable or disable)
- Latch Data On Leading or Trailing Edge of Strobe
- Prime Signal (enable or disable)
- TOF Action at Prime Signal (do nothing or form feed)
- Buffer Size in kilobytes (1 to 16)

Some application programs require a unique configuration. If the printer is not working properly in the configuration you have selected, contact an InfoPrint Solutions Company service representative.

Dataproducts Parallel Interface

The Dataproducts parallel interface allows the printer to operate with a 50-pin Amplimite (AMP) HDH-20 data cable connector. This adapter can be obtained as a feature on the InfoPrint 6500. The length of the data cable from the host computer to the printer must not exceed 40 feet (12 meters).

Table 8. Dataproducts Parallel Interface Connector Pin Assignments (with a 50-pin AMP HDH-20 Data Cable Connector)

Input Signals		Output Signals		Miscellaneous	
Signal	Pin	Signal	Pin	Signal	Pin
DATA LINE 1	19	READY	22	CABLE VERIFY	45, 46
Return	3	Return	6		
DATA LINE 2	20	ONLINE	21	GROUND	39
Return	4	Return	5		
DATA LINE 3	1	DEMAND/DATA REQ.	23		
Return	2	Return	7		
DATA LINE 4	41	PARITY ERROR	27		
Return	40		11		
DATA LINE 5	34				
Return	18				
DATA LINE 6	43				
Return	42				
DATA LINE 7	36				
Return	35				
DATA LINE 8	28				
Return	44				
DATA STROBE	38				
Return	37				
PAPER INSTRUCTION	30				
Return	14				
BUFFER CLEAR	31				
Return	15				

Note: Pins not listed are not connected

Dataproducts Parallel Interface Signals

Data Lines 1 through 8. Provides eight standard or inverted levels from the host that specify character data, plot data, or a control code. Data Line 8 allows access to the extended ASCII character set. You can enable or disable this line via the Data Bit 8 parameter on the Dataproducts submenu (see “Dataproducts Menu” on page 122).

Data Strobe. Carries a high true pulse from the host when data is ready. The data strobe remains high until the Data Request line goes false. The active edge of the strobe signal can be configured as leading, middle (default), or trailing.

Paper Instruction (PI). Carries a DVFU signal from the host with the same timing and polarity as the data lines.

Ready. Carries a high true signal from the printer when AC power and DC voltages are present, paper is loaded properly, and the printer is not in a check condition.

Online. Carries a high true signal from the printer when the Ready Line is true and the ON LINE key on the control panel has been pressed. When the printer is in online mode, it may accept data from the host.

Demand/Data Request. Carries a high true signal from the printer when the printer is ready to accept character data from the host. This signal changes to false shortly after the leading edge of the data strobe signal.

Cable Verify. Two pins on the interface connector are jumpered together to allow the user to verify proper installation of the interface connector.

Buffer Clear. A high true level from the host to indicate the printer should perform a reboot.

Parity Error. Always carries a low false signal from the printer indicating there is no parity error.

Dataproducts Parallel Interface Configuration

Your printer is configured at the factory to match the interface you specified. By using the operator panel, you may verify and change several interface parameters to meet specific application requirements.

Refer to “Dataproducts Menu” on page 122 for Dataproducts parameter descriptions and information on selecting values for the following parameters:

- Data Bit 8 (enable or disable)
- PI Ignored (enable or disable)
- Data Polarity (standard or inverted)
- Data Request Polarity (standard or inverted)
- Strobe Polarity (standard or inverted)

Some application programs require a unique configuration. If the printer is not working properly in the configuration you have selected, contact an InfoPrint Solutions Company service representative.

IEEE 1284 Parallel Interface

The IEEE 1284 is a parallel interface with bidirectional capabilities. Features include the following:

Faster data transmission. Timing of the signals has been reduced.

Bidirectional communication. Both the host and the printer can send data.

Versatility. If a device cannot send data along particular lines, the 1284 can work around this and send data via other operating modes, such as Nibble Mode which is discussed later.

Less user interaction. The host can ask the printer about printing status and supported features, such as fonts and internal errors. For example, instead of having to physically check if the printer has run out of paper, you can create a program to query this from the host. The printer will respond and a message will display on the host.

Operating Modes

The 1284 supports three operating modes, which are determined by negotiation between the printer and the host.

Compatibility Mode

This mode provides compatibility with a Centronics or PC Parallel interface (see Table 9 on page 203). Data is transferred from the host to the printer in 8-bit bytes over the data lines.

Compatibility Mode can be combined with Nibble and Byte Modes to provide bidirectional communication.

Nibble Mode

Eight bits equals one byte. When a byte of data is sent to the printer, the eight bits are sent over eight data lines.

Some devices cannot send data over their eight data lines. To bypass this, the 1284 permits data to be sent as half a byte over four status lines. (Half a byte equals one nibble.) Two sequential four-bit nibbles are sent over the lines.

Data is transferred from printer to host in four-bit nibbles over the status lines, and the host controls the transmission.

Byte Mode

The printer and host send data to each other along eight data lines (one bit per line).

If bidirectional communication is supported by the printer and the host, the host will take control of the data transfer.

The Negotiation Phase

The negotiation phase determines which operating mode will be used. At this time, the host and the printer will sense what devices are attached, the supported signals available, and which mode to use. The selected mode, in turn, defines the pins on the 1284 connector.

There are 36 pins on the parallel interface. Each one sends a different signal. Pin 1, for example, can send a Strobe signal or a HostClk signal, depending on the mode selected. See Table 9 for the different connector signals.

Signals

Table 9 lists each of the signals associated with the corresponding pins on the 1284 interface. Descriptions of the signals follow.

Table 9. 1284 Signals

Pin	Source of Data	Type of Mode		
		Compatible	Nibble	Byte
1	Host	nStrobe	HostClk	Host/Clk
2	Host/Printer	Data 1 (LSB)		
3	Host/Printer	Data 2		
4	Host/Printer	Data 3		
5	Host/Printer	Data 4		
6	Host/Printer	Data 5		
7	Host/Printer	Data 6		
8	Host/Printer	Data 7		
9	Host/Printer	Data 8 (MSB)		
10	Printer	nAck	PtrClk	PtrClk
11	Printer	Busy	PtrBusy	PtrBusy
12	Printer	PError	AckDataReq	AckDataReq
13	Printer	Select	Xflag	Xflag
14	Host	nAutoFd	Host Busy	HostAck
15		Not Defined		
16		Logic Grid		
17		Chassis Grid		
18	Printer	Peripheral Logic High		
19		Signal Ground (nStrobe)		
20		Signal Ground (Data 1)		
21		Signal Ground (Data 2)		
22		Signal Ground (Data 3)		

Table 9. 1284 Signals (continued)

Pin	Source of Data	Type of Mode		
		Compatible	Nibble	Byte
23		Signal Ground (Data 4)		
24		Signal Ground (Data 5)		
25		Signal Ground (Data 6)		
26		Signal Ground (Data 7)		
27		Signal Ground (Data 8)		
28		Signal Ground (PError, Select, nAck)		
29		Signal Ground (Busy, nFault)		
30		Signal Ground (nAutoFd, nSelectIn, nInit)		
31	Host	nInit		
32	Printer	NFault	nDataAvail	aDataAvail
33		Not Defined		
34		Not Defined		
35		Not Defined		
36	Host	nSelectIn	1284 Active	1284 Active

Note: The length of the data cable from the host computer to the printer should not exceed 32 feet (10 meters).

Host Clock / nWrite. Driven by host. Data transferred from host to printer. When printer sends data, two types are available. If Nibble mode, signal is set high. If Byte mode, signal is set low.

Data 1 through Data 8. These pins are host-driven in Compatibility mode and bidirectional in Byte mode. They are not used in Nibble mode. Data 1 is the least significant bit; Data 8 is the most significant bit.

Printer Clock / Peripheral Clock / Interrupt. Driven by the printer. A signal from the printer indicating the character or function code has been received and the printer is ready for the next data transfer.

Printer Busy / Peripheral Acknowledge / nWait. Driven by the printer. Indicates the printer cannot receive data. (Data bits 4 and 8 in Nibble mode.)

Acknowledge Data Request / nAcknowledge Reverse. Driven by the printer. Indicates the printer is in a fault condition. (Data bits 3 and 7 in Nibble mode.)

Xflag. Driven by the printer. A high true level indicating the printer is ready for data transfer and the printer is on line. (Data bits 2 and 6 in Nibble mode.)

Host Busy / Host Acknowledge / NDStrobe. Driven by the host. Activates auto-line feed mode.

Peripheral Logic High. Driven by the printer. When the line is high, the printer indicates all of its signals are in a valid state. When the line is low, the printer indicates its power is off or its signals are in an invalid state.

nReverse Request. Driven by the host. Resets the interface and forces a return to Compatibility mode idle phase.

nData Available / nPeripheral Request. Driven by the printer. Indicates the printer has encountered an error. (Data bits 1 and 5 in Nibble mode.)

1284 Active / nAStrobe. Driven by the host. A peripheral device is selected.

Host Logic High. Driven by the host. When set to high, the host indicates all of its signals are in a valid state. When set to low, the host indicates its power is off or its signals are in an invalid state.

nInit. Resets init interface from the host.

Terminating Resistor Configurations

The factory equips the printer with several resistors that are used for parallel interface configurations and are suitable for most applications. These 470 ohm pull-up and 1K ohm pull-down terminating resistors are located at RP1 and RP2, shown in Figure 65.

If the values of these terminating resistors are not compatible with the particular interface driver requirements of your host computer, you may need to install resistors with different pull-up and pull-down values.

Note: Must be installed by an InfoPrint Solutions Company service representative.

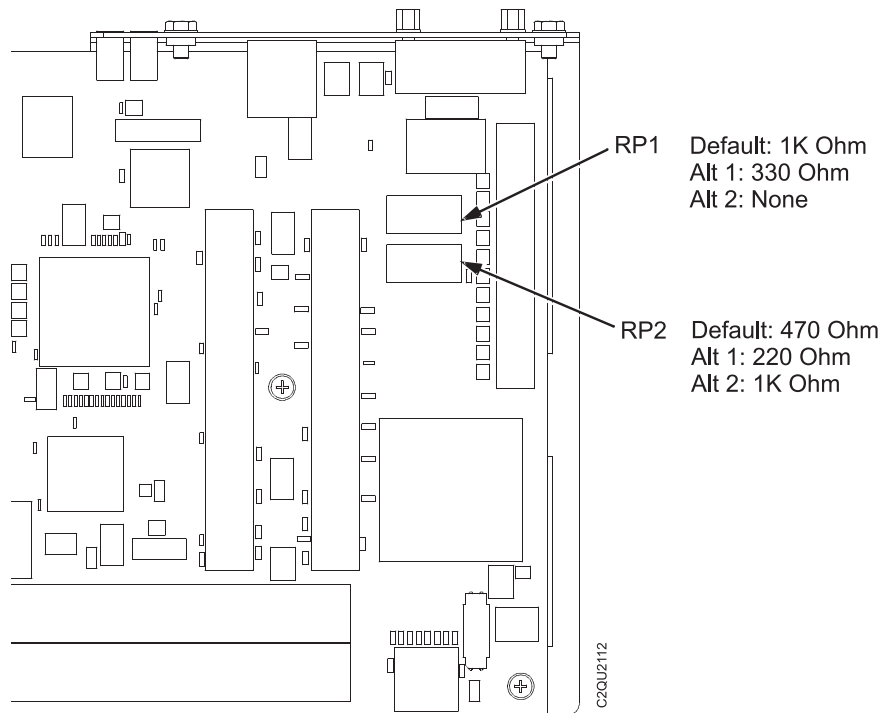

Figure 65. Resistor Locations

The shipping kit for this printer includes 220 ohm pull-up and 330 ohm pull-down alternate terminating resistors. If you install the 220 ohm pull-up resistor, you must also install the 330 ohm pull-down resistor. Table 10 lists the three terminating resistor configurations you can install:

Table 10. Terminating Resistor Configurations

Configuration	Pull-Up (RP1)	Pull-Down (RP2)
Factory Default	1K Ohm	470 Ohm
Alternate 1	330 Ohm	220 ohm
Alternate 2	none	1K Ohm

Removal And Installation

The procedure for removing and installing terminating resistors is provided in the *Maintenance Information Manual*.

IMPORTANT: This is an involved maintenance procedure. To avoid damage to the equipment, only a trained technician should perform this procedure.

Chapter 6. Reprogramming The Security Key

The security key on the PSA3 controller board can be reprogrammed with a Software Program Exchange (SPX) module.

The SPX is an intelligent module that plugs into the debug port on the back of printers equipped with the PSA3 “Hurricane” controller board. The SPX is used only once; it automatically overwrites itself after successfully reprogramming a security key. This allows the end user or a service technician to enable features such as new emulations without having to remove covers and install a new security key on the controller board.

The SPX is used at power-up only and is not left in the printer during normal operation. Because it is a single-use disposable item the user is not required to return it to the vendor or manufacturer.

How To Reprogram The Security Key

1. Power off the printer.
2. On cabinet models, open the rear door. On pedestal models, refer to Figure 66 to locate the debug port at the rear of the printer.
3. Insert the SPX into the debug port as shown.

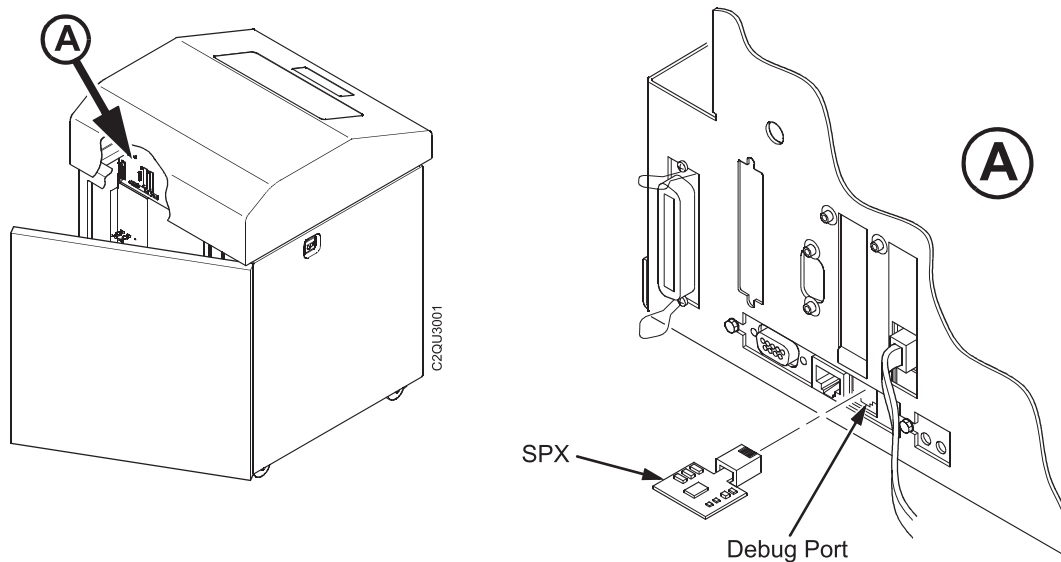

Figure 66. Inserting the SPX into the Debug Port

4. Power on the printer. The printer will begin its boot-up sequence.
5. When the printer detects a valid SPX, the control panel displays:
"NEW SPX DETECTED
PRESS ENTER"

Note: If an error message displays, find the message in the “Fault Messages” on page 221 and follow the troubleshooting instructions.

6. Press the **ENTER** key to activate the reprogramming sequence. The display will read:
"PROGRAMMING. PLEASE WAIT."
7. When the security key is reprogrammed, the display will read:
"REMOVE USED SPX
THEN PRESS ENTER"
8. Remove the SPX from the debug port at the rear of the printer.
9. Press the **ENTER** key. The printer will reboot itself and you may resume normal printing.
10. You may need to download the emulation again.
11. You may need to set additional menu parameters for any new features that have been added or enabled. (Refer to Chapter 4, "The Configuration Menus," on page 39.)

Chapter 7. Routine Service and Diagnostics

Overview

This section discusses general cleaning, running diagnostic tests, and understanding fault messages.

The printer requires no routine maintenance beyond regular cleaning. Periodically remove excess paper chaff and dust from the ribbon and paper paths. If print quality or paper motion deteriorates seriously even after cleaning, contact your InfoPrint Solutions Company service representative for prompt attention.

Cleaning Requirements

Periodic cleaning ensures efficient operation and clear print quality. If the printer is located in a dusty area or is used for heavy duty printing, clean it more often.



DANGER

<2>

Switch off printer power and unplug the printer power cord before cleaning the printer.

Exterior Cleaning

Clean the outside of the cabinet with a soft, lint-free cloth and mild detergent soap. (Dishwashing liquid works well.) Do not use abrasive powders or chemical solvents. Clean the windows with plain water or mild window cleaner.

Attention: Always apply the cleaning solution to the cloth; never pour cleaning solution directly onto the printer.

Interior Cleaning

Over time, particles of paper, ink, and ink transport media accumulate inside impact printers. This is normal. These particles must be removed periodically to avoid degraded print quality. Most paper particles accumulate around the ends of the platen and ink transport media path.

To clean the interior of the printer, refer to Figure 67 on page 213 (cabinet models) or Figure 68 on page 214 (pedestal models) and perform the following steps:

1. Power off the printer and unplug the printer power cord.
2. Open the printer cover.
3. Fully raise the platen lever.
4. Unload the paper.
5. Unlatch the ribbon spools and carefully lift them off the hubs.
6. Raise the ribbon out of the ribbon path.
7. Brush the paper dust and ribbon lint off the tractors, shuttle cover assembly, base casting, and ribbon guides with a soft-bristled, brush, nonmetallic brush (such as a toothbrush). Vacuum up the residue.
8. **Cabinet models:** Brush and vacuum up dust or residue that has accumulated inside the lower cabinet.
9. **Cabinet models:** Wipe the lower cabinet interior with a clean, lint-free cloth dampened with water and mild detergent. Dry the lower cabinet interior by wiping it with a clean, dry, lint-free cloth.
10. **Cabinet and Pedestal models:** Load the ribbon, load the paper, and set the top-of-form. Refer to the *InfoPrint 6500 Line Matrix Printer: Quick Start Guide*.

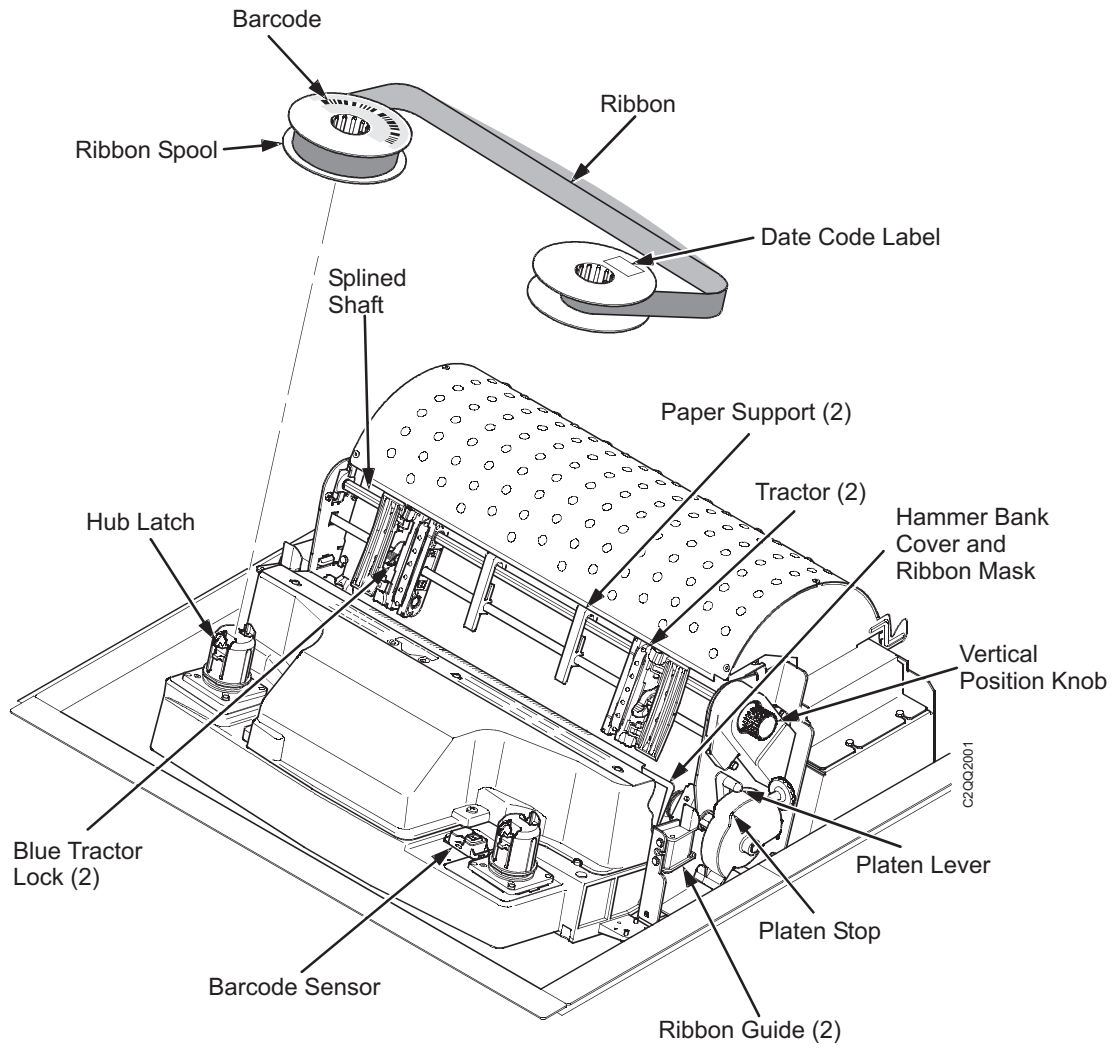

Figure 67. Interior Components of the Cabinet Models

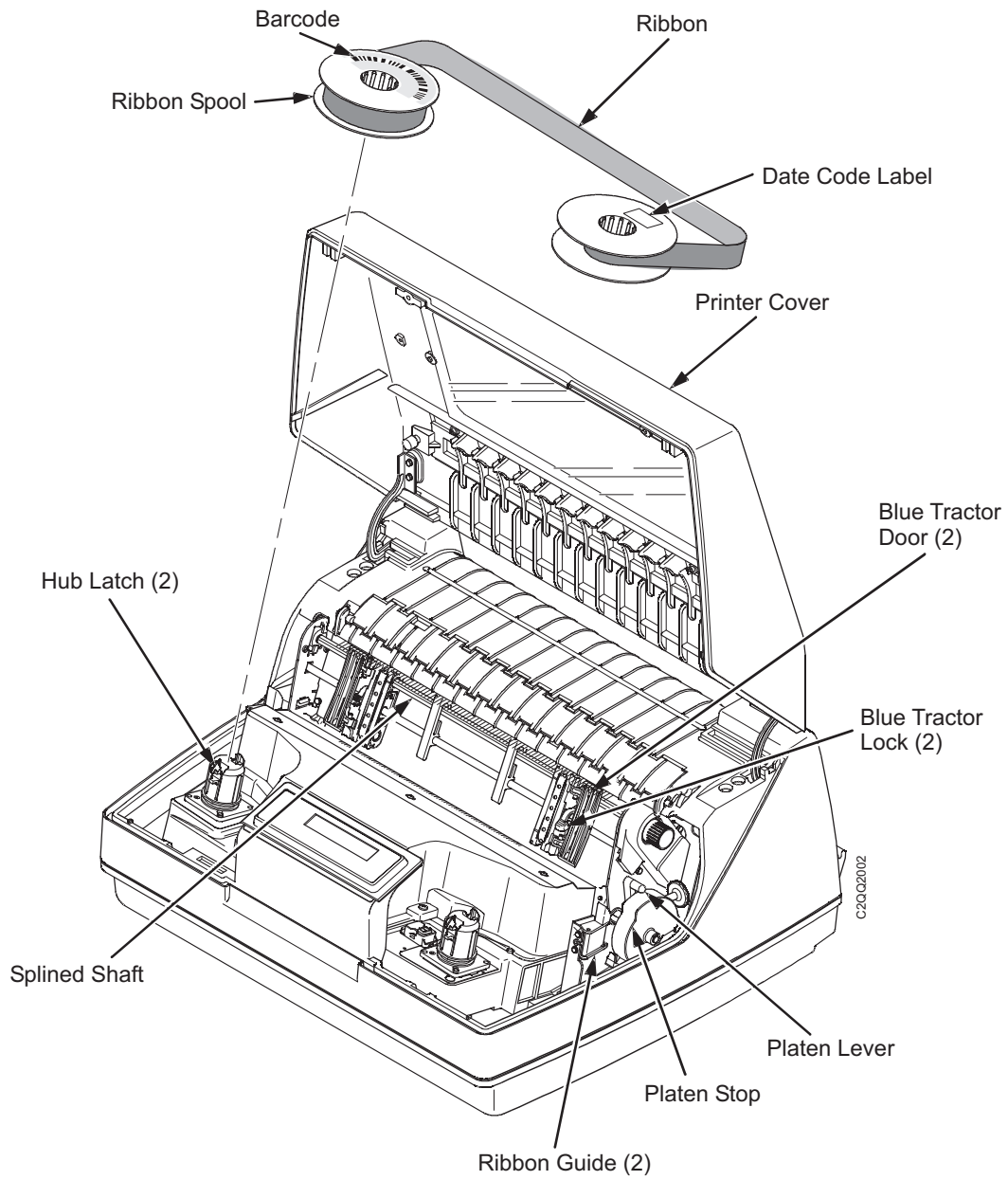

Figure 68. Interior Components of the Pedestal Models with Ribbon Spool Above

Printer Self-Tests

With the exception of testing the interface between the printer and the host computer (and the associated data cable), you do not need to send data from the host computer to the printer to test printer operation. You can use the printer's built-in diagnostic tests to check many of the functions of your printer, including print quality and overall operation. These diagnostic tests include the following:

- **Printer Demonstration**

Demonstrates all the functions and features available on the printer.

- **Print Error Log**

This test prints the contents of the printer's internal error log.

- **Ripple Print**

A "sliding" alphanumeric pattern used to identify missing or malformed characters, improper vertical alignment, or vertical compression.

- **All E's**

A pattern of all uppercase letter E's used to identify missing characters, misplaced dots, smeared characters, improper phasing, or light/dark character variations.

- **All H's**

A pattern of all uppercase letter H's used to detect missing characters or dots, smeared characters, or improper phasing.

- **All E's + FF (Form Feed)**















A pattern of all uppercase E's repeated for ten lines and followed by a form feed to the next page top-of-form, used to identify paper motion or feeding problems, such as paper path obstruction or improper forms.

- **Underlines**

An underline pattern useful for identifying hammer bank misalignment.

Note: The Operator Print Test menu is displayed in Chapter 4, "The Configuration Menus," on page 39.

Running the Printer Self-Tests

Step	Key	Result	Notes
1.			Make that the ribbon is installed and the printer is powered on and loaded with paper.
2.	Press 	NOT READY	Places the printer in NOT READY mode.
3.	 + 	OPERATOR MENU UNLOCKED	Press both keys at the same time. Unlocking the Operator Menu allows you to test your printer.
4.		OPERATOR MENU PRINTER CONTROL	First of the series of configuration menus.
5.	  UNTIL	OPERATOR MENU OPERATOR PRINT TESTS	Advances to the OPERATOR PRINT TESTS menu.
6.		OPERATOR PRINT TESTS PRINTER DEMONSTRATION*	Advances to PRINTER DEMONSTRATION, the first option in OPERATOR PRINT TESTS menu.
7.	  UNTIL	OPERATOR PRINT TESTS [TEST NAME]	Cycles through the list of print tests until you reach the name of the test you wish to run.
8.		OPERATOR PRINT TESTS [TEST NAME]	The print test you have selected starts printing at either 80 or 136 columns, as specified.
9.		OPERATOR PRINT TESTS [TEST NAME]	The print tests stops printing.
10.			Examine the print quality of the characters. They should be fully formed and of uniform density. If the test does not run or if text characters do not appear correctly formed, contact your InfoPrint Solutions Company service representative.
11.		NOT READY	Returns the printer to the NOT READY mode.
12.	 + 	OPERATOR MENU LOCKED	Locks Program mode and the Operator Menu.
13.		READY	Returns the printer to the READY mode.

Hex Code Printout

A hex code printout (or hex dump) lists each ASCII/EBCDIC data character received from the host computer, along with its corresponding two-digit hexadecimal code. Hex dumps can be used to troubleshoot some types of printer data reception problems.











To convert an ASCII/EBCDIC character to its corresponding hex code (or vice-versa), refer to the ASCII code chart in the *InfoPrint 6500 ASCII Programmer's Reference Manual*, or the EBCDIC code chart in the *InfoPrint 6500 Coax/Twinax Programmer's Reference Manual*.

Each printable character prints both as its assigned symbol and as its hex equivalent. Each nonprintable character prints both as a period (.) and as its hex equivalent.

When using a parallel interface, the letter "p" before a hex code indicates an active Paper Instruction (PI) line and a blank space before a hex code indicates an inactive PI line.

To obtain a hex code printout, perform the following steps.

Note: The asterisks (*) indicate steps specific to using the Coax/Twinax interface menus which are only displayed when the Coax/Twinax feature is installed.

Step	Key	Result	Notes
1. Press	STOP 	NOT READY	Places the printer in NOT READY mode.
2.	RETURN + ENTER 	OPERATOR MENU UNLOCKED	Press both keys at the same time. Unlocking the Operator Menu allows you to test your printer.
3.	MENU 	OPERATOR MENU PRINTER CONTROL	First of the series of configuration menus.
*		OPERATOR MENU COAX INTERFACE Or OPERATOR MENU TWINAX INTERFACE	Moves forward to the COAX INTERFACE or TWINAX INTERFACE option.
4.	ENTER 	PRINTER CONTROL INTERFACE SELECTION	Moves forward to the INTERFACE SELECTION option.
*		COAX INTERFACE PRINT LANGUAGE Or TWINAX INTERFACE PRINT LANGUAGE	
5.	 UNTIL	PRINTER CONTROL HEX PRINT MODE	Moves forward to the HEX PRINT MODE option.
*		COAX INTERFACE HEX PRINT MODE Or HEX PRINT MODE	Moves forward to the HEX PRINT MODE option.
6.	ENTER 	HEX PRINT MODE DISABLE*	Moves forward to DISABLE, the active option.
7.		HEX PRINT MODE ENABLE	Moves forward to ENABLE, the alternate option.
8.	ENTER 	HEX PRINT MODE ENABLE*	Asterisk (*) indicates this choice is now active.
9.	STOP 	NOT READY	Returns the printer to the NOT READY mode.
10.	RETURN + ENTER 	OPERATOR MENU LOCKED	Press both keys at the same time to relock the Operator Menu.

Step	Key	Result	Notes
11.	START ○	READY	Returns the printer to the READY mode.
		HEX DUMP ACTIVE	The message HEX DUMP ACTIVE flashes briefly.
12.	A hex code printout results when data is sent to the printer with HEX PRINT MODE enabled. After obtaining the printout, return to normal print mode by disabling HEX PRINT MODE.		
Note: Printing in Hex Mode may alter prior print attributes set by the host computer. A soft reset or power-off may be required after disabling HEX PRINT MODE.			

```

..... 00 01 02 03 04 05 06 07 08 09 0D 0A 0B 0C 0D 0A
..... 0E 0F 10 11 12 13 14 15 16 17 18 19 1A 1B 1C 1D
...ABCDEFGHIJKLM 1E 1F 20 41 42 43 44 45 46 47 48 49 4A 4B 4C 4D
NOPQRSTUVWXYZabc 4E 4F 50 51 52 53 54 55 56 57 58 59 5A 61 62 63
defghijklmnopqrs 64 65 66 67 68 69 6A 6B 6C 6D 6E 6F 70 71 72 73
tuvwxyz~!@#%^&* 74 75 76 77 78 79 7A 7E 21 40 23 24 25 5E 26 2A
()+1234567890-= 28 29 5F 2B 31 32 33 34 35 36 37 38 39 30 2D 3D
[]\;',./{}|:"<>? 5B 5D 5C 3B 27 2C 2E 2F 7B 7D 7C 3A 22 3C 3E 3F
..... 0D 0A 00 01 02 03 04 05 06 07 08 09 0D 0A 0B 0C
..... 0D 0A 0E 0F 10 11 12 13 14 15 16 17 18 19 1A 1B
....ABCDEFGHIJK 1C 1D 1E 1F 20 41 42 43 44 45 46 47 48 49 4A 4B
LMNOPQRSTUVWXYZa 4C 4D 4E 4F 50 51 52 53 54 55 56 57 58 59 5A 61
bcdefghijklmnopq 62 63 64 65 66 67 68 69 6A 6B 6C 6D 6E 6F 70 71
rstuvwxyz~!@#%^ 72 73 74 75 76 77 78 79 7A 7E 21 40 23 24 25 5E
&*()+1234567890 26 2A 28 29 5F 2B 31 32 33 34 35 36 37 38 39 30
-=[]\;',./{}|:"< 2D 3D 5B 5D 5C 3B 27 2C 2E 2F 7B 7D 7C 3A 22 3C
>?.. 3E 3F 0D 0A

```

Figure 69. Sample ASCII Hex Code Printout

PRINTER CONTROL INFORMATION AREA

```

ADDR  0  1  2  3  4  5  6  7  -  8  9  A  B  C  D  E  F
  0 = 20 04 00 00 00 00 00 00 - 00 00 13 70 1D 10 1C 00
 10 = 04 06 00 50 01 00 03 64 - 00 00 00 00 00 00 00 00
 20 = 00 00 00 00 00 00 00 00 - 00 00 00 00 00 00 00 00
 30 = 00 00 00 00 00 00 00 00 - 00 00 00 00 00 00 00 00
 40 = 00 00 00 00 00 00 00 00 - 00 00 00 00 00 00 00 00
    
```

PRINTER BUFFER AREA

```

ADDR  0  1  2  3  4  5  6  7  -  8  9  A  B  C  D  E  F
 50 = 00 01 02 03 04 05 06 07 - 0B 09 0A 0B 0C 0D 0E 0F
 60 = 10 11 12 13 14 15 16 17 - 18 19 1A 1B 1C 1D 1E 1F
 70 = 20 21 22 23 24 25 26 27 - 28 29 2A 2B 2C 2D 2E 2F
 80 = 30 31 32 33 34 35 36 37 - 38 39 4A 4B 4C 4D 4E 4F
 90 = 40 41 42 43 44 45 46 47 - 48 49 4A 4B 4C 4D 4E 4F
 A0 = 50 51 52 53 54 55 56 57 - 58 59 5A 5B 5C 5D 5E 5F
 B0 = 60 61 62 63 64 65 66 67 - 68 69 6A 6B 6C 6D 6E 6F
 C0 = 70 71 72 73 74 75 76 77 - 78 79 7A 7B 7C 7D 7E 7F
    
```

```

  ååååååçñç.<( + |
&èèèèèèìììì!$*);~
- / ÅÅÅÅÅÅÇÑ! , % >
øÉÉÉÉÌÌÌÌ: # @ ' = "
    
```

```

ADDR  0  1  2  3  4  5  6  7  -  8  9  A  B  C  D  E  F
 D0 = 80 81 82 83 84 85 86 87 - 88 89 8A 8B 8C 8D 8E 8F
 E0 = 90 91 92 93 94 95 96 97 - 98 99 9A 9B 9C 9D 9E 9F
 F0 = A0 A1 A2 A3 A4 A5 A6 A7 - A8 A9 AA AB AC AD AE AF
100 = B0 B1 B2 B3 B4 B5 B6 B7 - B8 B9 BA BB BC BD BE BF
110 = C0 C1 C2 C3 C4 C5 C6 C7 - C8 C9 CA CB CC BD CE CF
120 = D0 D1 D2 D3 D4 D5 D6 D7 - D8 D9 DA DB DC DD DE DF
130 = E0 E1 E2 E3 E4 E5 E6 E7 - E8 E9 EA EB EC ED EE EF
140 = F0 F1 F2 F3 F4 F5 F6 F7 - F8 F9 FA FB FC FD FE FF
    
```

```

0abcdefghijklmnopqraoæ Æ³
°jklmnopqraoæ Æ³
µ~stuvwxyzîîîîÿþ®
^£¥•©$¶¸²³[]~" ' x
{ABCDEFGHI-ôôôôô
}JKLMNOPQR¹úúúúÿ
\÷STUVWXYZ²ôôôôô
0123456789³úúúú
    
```

Figure 70. Sample Coax Hex Code Printout

```

0          |          1          |          2          |          3          |          4
000000000000000000001111111111111111112222222222222222333333333333333334
0123456789ABCDEF0123456789ABCDEF0123456789ABCDEF0123456789ABCDEF0

0          |          1          |          2          |          3          |
4444444444444444445555555555555555666666666666666677777777777777778
123456789ABCDEF0123456789ABCDEF0123456789ABCDEF0123456789ABCDEF0
  äääääääçñç.<( + | & é ê ë ì í î ï ð ! $ * ) ; - / Ä Å Æ Ç Ñ | , % _ > ? Ø É Ê Ë Ì Í Î Ï ' : # @ ' = " 0

0          |          1          |          2          |          3          |
88888888888888889999999999999999AAAAAAAAAAAAAAAAABBBBBBBBBBBBBBBBBBC
123456789ABCDEF0123456789ABCDEF0123456789ABCDEF0123456789ABCDEF0
abcdefghijklmnopqrstuvwxyzîÿþ*^£¥•©$¶%&[]" ' < > {

0          |          1          |          2          |          3          |
CCCCCCCCCCCCDDDDDDDDDDDDDDDEEEEEEEEEEEEEEEEEEEEEEEEEEEEEEEEEEEEE
123456789ABCDEF0123456789ABCDEF0123456789ABCDEF0123456789ABCDEF
ABCDEFGHI-ööööö}JKLMNOPQR¹úüüÿ\÷STUVWXYZ²öööööö0123456789³úüüü

```

Figure 71. Sample Twinax Hex Code Printout

Fault Messages

If a fault condition occurs in the printer, the Attention indicator on the operator panel lights, and the first line of the operator panel message display indicates the fault. The second line of the display indicates how to clear the fault.

Table 11 on page 222 explains each fault message and describes how to correct the fault condition. Displayed faults fall into one of two categories:

- Operator correctable.
- InfoPrint Solutions Company service representative required to correct.

Fault Correction Procedure

Before correcting a fault, read the fault explanation, then proceed to fix the problem, taking the following steps:

1. Write down the number of the error message(s) being displayed.
2. Read the fault explanation, then proceed to fix the problem, if possible.
3. Press **STOP** to clear the fault message. Press **START** to return to Ready mode, and resume printing.
4. If the fault message reappears, power off the printer, wait 15 seconds, then power on the printer.

5. Run your print job again. If the fault message reappears, turn off power to the printer, then call your InfoPrint Solutions Company service representative. Otherwise, no further attention is required.

The following table explains each fault message and offers suggestions for correcting the fault condition.

Table 11. Fault Messages

Fault Message	Operator Correctable?	Explanation	Solution
001 END OF FORMS LOAD FORMS	Yes	Printer is out of paper.	Load paper. Refer to the <i>Quick Start Guide</i> .
002 FORMS JAMMED CLEAR AND RELOAD FORMS	Yes	No paper motion.	Clear paper jam and reload paper. See the <i>User's Manual</i> . Reset platen lever.
003 FORMS EJECTED PRESS EJECT	Yes	Non-error status message.	Press Eject key to return paper to print position.
004 VIEW FORMS PRESS VIEW KEY	Yes	Non-error status message.	Press View key to return paper to print position.
006 HOST SYSTEM REQUESTS ATTN	Yes	Host attention message.	The host computer or printer controller requires attention.
007 FM HEADER ERROR	No	Frame Header Error. Application software has violated header parameters.	Contact your system administrator.
008 HOLD PRINT TIMEOUT PRESS START	Yes	Printer was off-line more than 10 minutes and the "Intervention Required" parameter is set to "Send to Host".	Press Start to put printer in READY state.
009 INVALID KEY PRESS	Yes	Appears briefly if an inactive key is pressed in current print mode.	Re-enter the value, or press the correct key.
010 PARAMETER ERROR	No	Illegal parameter value received in command code over a CT interface.	Contact your system administrator.
011 SCS COMMAND ERROR	No	In CT emulation, the printer received undefined control character (hex X'40').	Contact your system administrator.
012 STRUCTURED FLD ERROR	No	Applications software has violated structured data field parameters.	Contact your system administrator.
013 ACTIVATE LOST	No	The printer detects a Twinax protocol communication error and reports the error.	Power off the printer.
014 INVALID ACTIVATE	No	Printer detects a Twinax protocol communications error and reports the error.	The printer reports the error.

Table 11. Fault Messages (continued)

Fault Message	Operator Correctable?	Explanation	Solution
015 COMMUNICATION CHECK CHECK CABLE	Yes	Communication check: a message that appears in the CT emulation indicating that the line is not active on a Twinax interface.	Check cable connection.
016 INVALID COMMAND	No	Printer detects Twinax protocol communications error and reports the error.	The printer reports the error; host action is required.
017 STACKER JAM	Yes	Paper is jammed in the power stacker area.	<ol style="list-style-type: none"> 1. Open the cabinet rear door and check for obstructions preventing elevator movement. Remove any obstructions. 2. Run the print job again. If the message reappears, contact your InfoPrint Solutions Company service representative.
018 STACKER FULL CHECK STACKER	Yes	Status message: power stacker is full of paper.	Remove paper.
019 STACKER FAULT CHECK STACKER	Yes	Stacker is not functioning correctly	Check for obstructions in the stacker area. If fault persists, contact your InfoPrint Solutions Company service representative.
021 PRINT BUFFER OVERRUN	Yes	The print buffer has overflowed in the CT Twinax emulation. The printed output may contain random asterisk (*) characters. Make a configuration printout.	Check printer serial port configuration setup. Ensure that baud rate matches both host and printer settings.
022 UNIT ADDRESS INVALID	Yes	Poll timeout on the Twinax interface indicating the unit address is not recognized by the printer.	Ensure that printer address matches host setting.
024 SERIAL LINE PARITY ERROR	Yes	Parity error.	Check printer serial port configuration setup. Ensure that parity setting matches both host and printer settings.
025 FRAMING ERROR VERIFY CONFIGURATION	Yes	Framing error. (Serial interface)	Check printer serial port configuration setup. Ensure that it matches host setting.
026 HEX DUMP MODE	N/A	Printer attach status message.	No action necessary.
027 COMMUNICATIONS CHECK CALL SYSTEM OPERATOR	Yes	Enable poll timeout. The printer was not enabled for one minute. (Coax interface)	Check cable connection and host system.
028 COMMUNICATIONS CHECK CALL SYSTEM OPERATOR	Yes	Controller unit not enabled. Poll timeout error. The printer was not polled for one minute. (Coax interface)	Check cable connection and host system.

Table 11. Fault Messages (continued)

Fault Message	Operator Correctable?	Explanation	Solution
029 8344 DIAGNOSTIC FAILED	No	Link-level code test detects hardware failure on the CT board.	Contact your InfoPrint Solutions Company service representative.
031 END OF FORMS TIMEOUT LOAD FORMS	Yes	In the CT emulation with a Coax interface, a timeout message is sent to the host if paper is not loaded within 10 minutes after CLEAR was pressed to clear a paper out fault.	Load paper. Refer to the <i>User's Manual</i> for procedures.
032 FORMS JAMMED TIMEOUT CLEAR AND RELOAD FORMS	Yes	In the CT emulation with a Coax interface, a time-out message is sent to the host if paper motion has not occurred for 10 minutes after CLEAR was pressed to clear a paper jam fault.	Clear paper jam and reload paper. Refer to the <i>User's Manual</i> for procedures..
034 TRNSPT STALL TIMEOUT CHECK TRANSPORT	Yes	In the CT emulation with a Coax interface, the transport has not moved for 10 minutes after CLEAR was pressed to clear the transport drive fault.	Make sure the ribbon is not twisted and the platen lever is set to match thickness of media being used. If fault reoccurs, contact your InfoPrint Solutions Company service representative.
035 RIBBON OUT OF INK INSTALL NEW RIBBON	Yes	Ribbon out of ink set by RibbonMinder.	Install new ribbon.
037 STACKER JAM TIMEOUT CHECK STACKER	Yes	A timeout message is sent to the host if paper is not loaded 10 minutes after Stop was pressed to clear the stacker jam fault.	Clear stacker jam and reload paper. See <i>User's Guide</i> for procedure.
038 STACKER FULL TIMEOUT CHECK STACKER	Yes	A timeout message is sent to the host if paper is not loaded 10 minutes after Stop was pressed to clear the stacker full fault.	Remove paper from the stacker.
039 STACKER FAULT CHECK STACKER	Yes	A timeout message is sent to the host if paper is not loaded 10 minutes after Stop was pressed to clear the stacker fault.	Check for obstructions in the stacker area. If fault persists, contact your InfoPrint Solutions Company service representative.
041 BUFFER OVERFLOW VERIFY CONFIGURATION	Yes	Host sends data after the printer buffer is full. (Serial interface.)	Check printer serial port configuration setup. Ensure that the Data Terminal Ready setting matches both host and printer settings.
042 NO CUSTOM SET AVAIL SAVE FIRST	Yes	This custom configuration set does not exist.	Save the custom set. Refer to "Saving Your Configuration in a Custom Set" on page 32.

Table 11. Fault Messages (continued)

Fault Message	Operator Correctable?	Explanation	Solution
043 CUSTOM SET EXISTS DELETE FIRST	Yes	Custom set is write-protected.	Delete existing set, then save new set.
044 EC FIRMWARE/ HARDWARE ERROR	No	Fatal firmware error on the controller board.	Contact your InfoPrint Solutions Company service representative.
045 FIRMWARE ERROR* SEE USER'S MANUAL	No	Application software tried to perform an illegal printer function or damaged memory is detected on the controller board.	Contact your InfoPrint Solutions Company service representative.
046 EC STOPPED AT STATE <state>	No	Controller self-test and initialization sequence was halted at <state>, where <state> is one of 10 numerically coded messages.	Contact your InfoPrint Solutions Company service representative.
051 HAMMER SHORT* SEE USER'S MANUAL	No	Hammer driver circuits on the controller board shorted to ground.	Contact your InfoPrint Solutions Company service representative.
052 MECH DRIVER HOT SEE USER'S MANUAL	No	Mechanism driver temperature is elevated beyond normal threshold.	Contact your InfoPrint Solutions Company service representative.
053 48 VOLTS FAILED* RECYCLE POWER	No	The power supply is not generating a proper 48 volts or the CMX board is not properly detecting a 48 volt output.	Contact your InfoPrint Solutions Company service representative.
054 HAMMER COIL SHORT* SEE USER'S MANUAL	No	Hammer coil shorted to ground.	Contact your InfoPrint Solutions Company service representative.
055 MECH. DRIVER LINK FAILURE SEE USER'S MANUAL	No	Link failure before the controller board and mechanism driver board.	Contact your InfoPrint Solutions Company service representative.
056 HAMMER COIL CHECK SEE USER'S MANUAL	No	Hammer coil is open.	Contact your InfoPrint Solutions Company service representative.
057 CLOSE PLATEN	Yes	Platen lever is raised to the open position.	Lower the platen lever.
058 SHUTTLE JAM SEE USER'S MANUAL	No	No shuttle movement or the shuttle is moving at the wrong speed.	Make sure the ribbon is not twisted and the platen lever is set correctly. If the fault reoccurs, contact your InfoPrint Solutions Company service representative.
059 CANCEL PRINT ACTIVE	N/A	Non-error status message.	No action required.
060 PRINTER HOT SEE USER'S MANUAL	No	Printer temperature is elevated beyond normal threshold.	Contact your InfoPrint Solutions Company service representative.

Table 11. Fault Messages (continued)

Fault Message	Operator Correctable?	Explanation	Solution
062 EXHAUST FAN CHECK SEE USER'S MANUAL	Yes	Sensors cannot detect current in fan circuit.	Power off the printer. Check for obstruction of vents and fan airway; remove any obstructions. Check for items beneath the printer blocking cabinet vents. Power back on the printer. If this message reoccurs, contact your InfoPrint Solutions Company service representative. Note: This message should not appear on a Pedestal model. If this message does appear, contact your InfoPrint Solutions Company Service Representative.
065 HAMMER FAN CHECK* SEE USER'S MANUAL	Yes	Sensors cannot detect current in fan circuit.	Power off the printer. Check for obstruction of vents and fan airway; remove any obstructions. Check for items beneath the printer blocking cabinet vents. Power back on the printer. If this message reoccurs, contact your InfoPrint Solutions Company service representative.
069 DATA CLEARED	N/A	Appears when data is cleared out of printer after Cancel key has been pressed.	No action necessary.
080 POWER SUPPLY HOT	No	Power supply temperature is elevated beyond normal threshold.	Contact your InfoPrint Solutions Company service representative.
081 POWER VOLT CHECK* SEE USER'S MANUAL	No	Power supply voltage failure.	Contact your InfoPrint Solutions Company service representative.
082 POWER 8.5V CHECK* SEE USER'S MANUAL	No	Internal power failure.	Contact your InfoPrint Solutions Company service representative.
083 INTAKE FAN CHECK* SEE USER'S MANUAL	Yes	Sensors cannot detect current in fan circuit.	Power off the printer. Check for obstruction of vents and fan airway; remove any obstructions. Check for items beneath the printer blocking cabinet vents. Power back on the printer. If this message reoccurs, contact your InfoPrint Solutions Company service representative.
084 POWER 48V CHECK* SEE USER'S MANUAL	No	Controller voltage failure. 15 V failure on the controller board.	Contact your InfoPrint Solutions Company service representative.

Table 11. Fault Messages (continued)

Fault Message	Operator Correctable?	Explanation	Solution
085 CONTROL VOLT CHECK SEE USER'S MANUAL	No	Controller voltage failure.	Contact your InfoPrint Solutions Company service representative.
086 CONTROL 15V CHECK* SEE USER'S MANUAL	No	Controller voltage failure.	Contact your InfoPrint Solutions Company service representative.
087 PLATEN OPEN TIMEOUT CLOSE PLATEN	Yes	In the CT emulation with a Coax interface, the platen lever has been open for at least one minute.	Lower (close) the platen lever.
088 CONTROL 23.5V CHECK* SEE USER'S MANUAL	No	Controller voltage failure.	Contact your InfoPrint Solutions Company service representative.
089 RIBBON STALL CHECK TRANSPORT	Yes	The controller board does not detect ribbon movement.	Make sure the ribbon is not twisted and the platen lever is set to match thickness of media being used. If fault reoccurs, contact your InfoPrint Solutions Company service representative.
090 SHUTTLE COVER OPEN CLOSE SHUTTLE COVER	No	Shuttle cover is missing, damaged, or not correctly installed.	Contact your InfoPrint Solutions Company service representative.
092 TRNSPRT DRVR CIRCUIT SEE USER'S MANUAL	No	The controller board does not detect transport drive motor.	Contact your InfoPrint Solutions Company service representative.
101 UPPER DRIVER SHORT* SEE USER'S MANUAL	No	Upper driver short. Hammer driver circuits on the controller board shorted to ground.	Contact your InfoPrint Solutions Company service representative.
102 LOWER DRIVER SHORT* SEE USER'S MANUAL	No	Circuit(s) on the hammer bank or in the hammer bank power cable shorted to ground.	Contact your InfoPrint Solutions Company service representative.
104 ERROR:DP FIFO BUSY	No	There is a timing problem in the Engine Controller (EC) firmware.	Cycle power. If problem does not clear, contact your InfoPrint Solutions Company service representative.
105 HAMMER <#> CHECK	No	Hammer coil is open.	(You can continue to print with degraded print quality.) Contact your InfoPrint Solutions Company service representative.
110 STACK OVERFLOW* SEE USER'S MANUAL	No	Fatal firmware error on the controller board.	Contact your InfoPrint Solutions Company service representative.
111 STACK UNDERFLOW*	No	Fatal firmware error on the controller board.	Contact your InfoPrint Solutions Company service representative.

Table 11. Fault Messages (continued)

Fault Message	Operator Correctable?	Explanation	Solution
112 UNDEFINED OPCODE* SEE USER'S MANUAL	No	Undefined Opcode. Fatal firmware error on the controller board.	Contact your InfoPrint Solutions Company service representative.
113 INSTRUCTION SET SEE USER'S MANUAL	No	Protected Instruction. Fatal firmware error on the controller board.	Contact your InfoPrint Solutions Company service representative.
114 ILLGL OPR ACCESS SEE USER'S MANUAL	No	Illegal Operand Accessed. Fatal firmware error on the controller board.	Contact your InfoPrint Solutions Company service representative.
115 ILLGL INSTR ACCESS* SEE USER'S MANUAL	No	Fatal firmware error on the controller board.	Contact your InfoPrint Solutions Company service representative.
116 ILLEGAL BUS ACCESS SEE USER'S MANUAL	No	Illegal External Bus Access. Fatal firmware error on the controller board.	Contact your InfoPrint Solutions Company service representative.
117 A TO D OVERUN* SEE USER'S MANUAL	No	Analog to Digital Overrun. The analog-to-digital converter overflowed.	Contact your InfoPrint Solutions Company service representative.
118 UNDEFINED INTERRUPT	No	Undefined interrupt. Fatal firmware error on the controller board.	Contact your InfoPrint Solutions Company service representative.
119 TCB CORRUPTED* SEE USER'S MANUAL	No	Task control block corrupted. Fatal firmware error on the controller board.	Contact your InfoPrint Solutions Company service representative.
120 MACHINE CHECK* SEE USER'S MANUAL	No	The processor tried to access a pointer that contains nothing (null).	Contact your InfoPrint Solutions Company service representative.
121 PAPER NOT AT SPEED SEE USER'S MANUAL	No	Paper not at speed. Fatal firmware error on the controller board.	Contact your InfoPrint Solutions Company service representative.
122 PAPER NOT SCHEDULED SEE USER'S MANUAL	No	Paper not scheduled. Fatal firmware error on the controller board.	Contact your InfoPrint Solutions Company service representative.
123 PAPER BUSY TOO LONG SEE USER'S MANUAL	No	Paper busy too long. Fatal firmware error on the controller board.	Contact your InfoPrint Solutions Company service representative.
124 PAPER FIFO OVERFLOW SEE USER'S MANUAL	No	Paper first in first out overflow. Fatal firmware error on the controller board.	Contact your InfoPrint Solutions Company service representative.
125 PAPER FIFO UNDERFLOW SEE USER'S MANUAL	No	Paper first in first out underflow. Fatal firmware error on the controller board.	Contact your InfoPrint Solutions Company service representative.
126 PAP FEED BAD TABLE* SEE USER'S MANUAL	No	Paper bad table. Fatal firmware error on the controller board.	Contact your InfoPrint Solutions Company service representative.
127 ILLEGAL STATE SEE USER'S MANUAL	No	Paper illegal state. Fatal firmware error on the controller board.	Contact your InfoPrint Solutions Company service representative.

Table 11. Fault Messages (continued)

Fault Message	Operator Correctable?	Explanation	Solution
128 INVALID COMMAND SEE USER'S MANUAL	No	Paper invalid command. Fatal firmware error on the controller board.	Contact your InfoPrint Solutions Company service representative.
129 INVALID PARAMETER SEE USER'S MANUAL	No	Paper invalid parameter. Fatal firmware error on the controller board.	Contact your InfoPrint Solutions Company service representative.
130 PAP FEED INCOMPLETE SEE USER'S MANUAL	No	Paper incompletely energized. Fatal firmware error on the controller board.	Contact your InfoPrint Solutions Company service representative.
131 UNEXPECTED INTERRUPT SEE USER'S MANUAL	No	Paper unexpected interrupt. Fatal firmware error on the controller board.	Contact your InfoPrint Solutions Company service representative.
132 RIBBON INVALID COMMAND SEE USER'S MANUAL	No	Ribbon invalid command. Fatal firmware error on the controller board.	Contact your InfoPrint Solutions Company service representative.
133 RIBBON INVALID STATE SEE USER'S MANUAL	No	Ribbon invalid state. Fatal firmware error on the controller board.	Contact your InfoPrint Solutions Company service representative.
134 INVALID COMMAND SEE USER'S MANUAL	No	Platen invalid command. Fatal firmware error on the controller board.	Contact your InfoPrint Solutions Company service representative.
135 INVALID STATE* SEE USER'S MANUAL	No	Platen invalid state. Fatal firmware error on the controller board.	Contact your InfoPrint Solutions Company service representative.
136 INVALID PARAMETER SEE USER'S MANUAL	No	Platen invalid parameter. Fatal firmware error on the controller board.	Contact your InfoPrint Solutions Company service representative.
137 SHUTL INVALID COMMAND* SEE USER'S MANUAL	No	Shuttle invalid command. Fatal firmware error on the controller board.	Contact your InfoPrint Solutions Company service representative.
138 SHUTTLE INVALID PARAMETER	No	Shuttle invalid parameter. Fatal firmware error on the controller board.	Contact your InfoPrint Solutions Company service representative.
139 OVER SPEED CHECK* SEE USER'S MANUAL	No	The shuttle is running over speed. Fatal firmware error on the controller board.	Contact your InfoPrint Solutions Company service representative.
140 48 VOLTS FAILED* SEE USER'S MANUAL	No	The power supply is not generating a proper 48 Volts, or the controller board is not detecting a 48 Volt output from the power supply board.	Contact your InfoPrint Solutions Company service representative.
142 PAP FEED DRIVE FAIL* SEE USER'S MANUAL	No	Paper feed drive failed. The paper feed driver circuit on the controller board is drawing too much current.	Contact your InfoPrint Solutions Company service representative.

Table 11. Fault Messages (continued)

Fault Message	Operator Correctable?	Explanation	Solution
143 SHUTL DRIVER FAILED* SEE USER'S MANUAL	No	Shuttle driver failed. The shuttle driver circuit on the controller board is drawing too much current.	Contact your InfoPrint Solutions Company service representative.
144 SHUTTLE FAN FAILURE* SEE USER'S MANUAL	No	The shuttle fan fails to blow correctly.	Contact your InfoPrint Solutions Company service representative.
146 RIBBON INK OUT INSTALL NEW INFOPRINT RIBBON	Yes	RibbonMinder software has determined that the ribbon is out of ink.	Change the ribbon or reset the RibbonMinder to a lighter setting. See "Ribbon End Point" on page 53.
147 H/B CONTROL MODE SEE USER'S MANUAL	No	One or more hammer coils is overheating.	Contact your InfoPrint Solutions Company service representative.
148 DRIVER CIRCUIT BAD SEE USER'S MANUAL	No	Driver circuit is faulty. The hammer coil count test failed.	Contact your InfoPrint Solutions Company service representative.
149 HMR BANK NOT INSTALLED SEE USER'S MANUAL	No	Hammer bank not installed.	Contact your InfoPrint Solutions Company service representative.
150 ERROR: EC STOPPED AT STATE XXXX	No	XXXX is a number from 0000 to 0010. The Entire Controller has stopped and is in the state identified by the number displayed.	Contact your InfoPrint Solutions Company service representative.
159 HAMMERBANK HOT	No	The hammerbank is overheating.	Contact your InfoPrint Solutions Company service representative.
160 ERROR: DC PROGRAM NOT VALID	No	The printer cannot find the data controller program or the validation checksum is corrupt.	Contact your InfoPrint Solutions Company service representative.
161 ERROR: DRAM AT ADDRESS XXXXXXXX	No	The printer found a defective memory location.	Contact your InfoPrint Solutions Company service representative.
162 ERROR: EC PROGRAM NOT VALID	Yes	The printer cannot find the engine controller program or the validation checksum is corrupt.	Download the program again. If the fault message appears again, contact your InfoPrint Solutions Company service representative.
163 ERROR: FLASH DID NOT PROGRAM	Yes	The printer encountered an error trying to program flash memory.	Download the program again. If the fault message appears again, contact your InfoPrint Solutions Company service representative.
164 ERROR: SDRAM JEDEC MISSING	No	The printer could not find JEDEC table for SDRAM using default values.	Contact your InfoPrint Solutions Company service representative.

Table 11. Fault Messages (continued)

Fault Message	Operator Correctable?	Explanation	Solution
165 ERROR: NO DRAM DETECTED	No	The printer could not find any DRAM.	Contact your InfoPrint Solutions Company service representative.
166 ERROR: NVRAM FAILURE	No	The nonvolatile SRAM on the controller board has failed.	Contact your InfoPrint Solutions Company service representative.
167 ERROR: PROGRAM NEEDS MORE DRAM	No	The printer requires more DRAM to run the downloaded program.	Contact your InfoPrint Solutions Company service representative.
168 ERROR: PROGRAM NEEDS MORE FLASH	No	The printer requires more flash memory to run the downloaded program.	Contact your InfoPrint Solutions Company service representative.
169 ERROR: PROGRAM NOT COMPATIBLE	No	The printer is not compatible with the downloaded program.	Contact your InfoPrint Solutions Company service representative.
170 ERROR: PROGRAM NOT VALID	No	The printer does not see a program in flash memory.	Contact your InfoPrint Solutions Company service representative.
171 ERROR: SHORT AT ADDRESS XXXX	No	Hardware failure in DRAM or controller circuitry.	Contact your InfoPrint Solutions Company service representative.
172 ERROR: WRITING TO FLASH	No	Hardware or software fault in flash memory.	Contact your InfoPrint Solutions Company service representative.
173 ERROR: WRONG CHECKSUM	No	The printer received the complete program but the checksum did not match.	Contact your InfoPrint Solutions Company service representative.
174 ERROR OCCURRED FLUSHING QUEUES*	No	An interim message that displays while the printer discards host data it cannot use because a fault condition exists.	Contact your InfoPrint Solutions Company service representative.
175 ACCESS NULL POINTER* SEE USER'S MANUAL	No	Application software tried to perform an illegal printer function or damaged logic circuits were detected on the controller board.	Contact your InfoPrint Solutions Company service representative.
180 ETHERNET ADDRESS ADAPTER NOT INSTALLED	Yes	The Ethernet PCBA is not enabled or did not initialize correctly.	Install the Ethernet Address Adapter.
181 ETHERNET ADAPTER BEING INITIALIZED	N/A	Status message indicating that the Ethernet Interface is processing the boot procedure.	No action required.
182 ETHERNET DETECTED	N/A	Status message indicating that the Ethernet Interface has established communication.	No action required.

Table 11. Fault Messages (continued)

Fault Message	Operator Correctable?	Explanation	Solution
190 SECURITY ERROR SEE USER'S MANUAL	No	Security Key intended for ribbon use installed on CDB machine.	Contact your InfoPrint Solutions Company service representative.
191 SECURITY CODE VIOLATION	No	Security Key does not match emulation.	Contact your InfoPrint Solutions Company service representative.
192 SECURITY KEY NOT DETECTED	No	The Security Key is not present or has failed.	Contact your InfoPrint Solutions Company service representative.
194 INCOMPAT. E-NET NIC REPLACE NIC	No	The Ethernet installed in the printer is not the correct part number for the 6500 printer.	Contact your InfoPrint Solutions Company service representative.
195 INCOMPAT. WLAN NIC REPLACE NIC	No	The wireless Ethernet installed in the printer is not the correct part number for a 6500 printer.	Contact your InfoPrint Solutions Company service representative.
200 SOFTWARE ERROR* RECYCLE POWER	No	Application software tried to perform an illegal printer function or damaged logic circuits were detected on the controller board.	Contact your InfoPrint Solutions Company service representative.
301 RIBBON INK LOW INSTALL NEW INFOPRINT RIBBON	Yes	Message is displayed when RibbonMinder feature is installed and ribbon ink reaches 2% level.	Install a new InfoPrint ribbon.
302 EXCESSIVE RIBBON WEAR INSTALL NEW INFOPRINT RIBBON	Yes	Displayed when ribbon reaches end of life, whether RibbonMinder is enabled or not.	Install a new InfoPrint ribbon.
303 BARCODE NOT DETECTED INSTALL NEW INFOPRINT RIBBON	Yes	No barcode seen on the ribbon spool. Indicates missing label or damaged sensor.	Install a new InfoPrint ribbon.
304 BARCODE DAMAGED REVERSE RIBBON SPOOLS	Yes	Barcode detected, but not complete.	Reverse the ribbon spools.
305 OLD RIBBON DETECTED INSTALL NEW INFOPRINT RIBBON	Yes	Ribbon was previously declared end-of-life on the installed machine.	Install a new InfoPrint ribbon.
306 UNKNOWN RIBBON INSTALL NEW INFOPRINT RIBBON	Yes	Ribbon was not an InfoPrint coded barcode.	Install a new InfoPrint ribbon.
307 UNKNOWN RIBBON INSTALL NEW INFOPRINT RIBBON	Yes	Ribbon not authorized.	Install a new InfoPrint ribbon.

Table 11. Fault Messages (continued)

Fault Message	Operator Correctable?	Explanation	Solution
308 BARCODE SENSOR ERR SEE USER'S MANUAL	Yes	Bar code read error: The printer does not detect the presence of the ribbon bar code sensor.	<ol style="list-style-type: none"> 1. Power down the printer. Remove the ribbon and wipe the two lenses of the ribbon bar code sensor with a lint-free cloth or cotton swab. 2. Install the ribbon and power on the printer. If the message appears again, replace the ribbon. 3. Power on the printer. If the message appears again, InfoPrint service representative.
733 DP FIFO BUSY*	No	There is a timing problem in the Engine Controller firmware.	Contact your InfoPrint Solutions Company service representative.
990 MACHINE CHECK	N/A	Host status message.	No action required.
998 NV-RAM CHECK	No	The flash memory is defective.	Contact your InfoPrint Solutions Company service representative. Note: You can still print, but you cannot save configuration changes as the NVRAM is defective.
48V CIRCUIT*	No	The power supply is not generating a proper 48 Volt, or the controller board is not detecting a 48 Volt output from the power supply board.	Contact your InfoPrint Solutions Company service representative.
A97 GRAPHIC CHECK ERROR PRESS STOP THEN START	Yes	Graphic Check Error: CT emulation.	Press Stop then Start .
B10 ERROR: NO DRAM DETECTED*	No	Boot-up routines did not detect the presence of SDRAM DIMM.	Contact your InfoPrint Solutions Company service representative.
B11 ERROR: RAM TEST FAILED*	No	SDRAM failed the boot initialization test.	Contact your InfoPrint Solutions Company service representative.
B12 ERROR: PROGRAM MISSING*	Yes	The printer does not see a program in flash memory.	There is no program in printer memory. Download the emulation.
B13 ERROR: NOT COMPATIBLE*	Yes	The printer is not compatible with the downloaded program.	Use the correct emulation software option(s) for this printer model.
B19 ERROR: DC RETURNED*	No	This message indicates an incorrectly assembled and tested machine.	Contact your InfoPrint Solutions Company service representative.

Table 11. Fault Messages (continued)

Fault Message	Operator Correctable?	Explanation	Solution
B20 STATUS: 00% DOWNLOAD MODE	N/A	Status message informing the operator that software is being downloaded.	No action required.
B21 STATUS: PRINTER RESET	N/A	Status message informing the operator that the printer is undergoing a system reset.	No action required.
B22 ERROR: DECOMPRESS SIZE*	No	Flash memory has not passed boot initialization tests.	Contact your InfoPrint Solutions Company service representative.
B23 ERROR: DECOMPRESS CKSUM*	No	Flash memory has not passed boot initialization tests.	Contact your InfoPrint Solutions Company service representative.
B30 - STATUS:INITIALIZING	N/A	Status message informing the operator that software is being downloaded through one of the printer's I/O ports using the two-key download activation.	No action required.
B35 STATUS: WAITING FOR EC STATUS	Yes	Status message: the DC on the controller board is waiting for communication with the EC. If this message does not clear within a few seconds there is an electrical or electronic problem on the controller board.	Cycle power. If the message still appears contact your InfoPrint Solutions Company service representative.
B40 ERROR: SDRAM EEPROM CKSUM BAD*	No	Flash memory has not passed boot initialization tests.	Contact your InfoPrint Solutions Company service representative.
B41 ERROR: DIMM MEMORY NOT SDRAM*	No	The DRAM DIMM installed on the controller board is not Synchronous DRAM (SDRAM).	Contact your InfoPrint Solutions Company service representative.
B42 ERROR: SDRAM ROWS NOT ALLOWED*	No	Printer boot initialization tests detect incorrect SDRAM.	Contact your InfoPrint Solutions Company service representative.
B43 ERROR: SDRAM TOO MANY BANKS*	No	Printer boot initialization tests detect incorrect SDRAM.	Contact your InfoPrint Solutions Company service representative.
B44 ERROR: SDRAM NOT 64 BITS WIDE*	No	Printer boot initialization tests detect incorrect SDRAM.	Contact your InfoPrint Solutions Company service representative.
B45 ERROR: SDRAM IS WRONG VOLTAGE*	No	Printer boot initialization tests detect incorrect SDRAM.	Contact your InfoPrint Solutions Company service representative.
B46 ERROR: SDRAM HAS MIXED SIZES*	No	Printer boot initialization tests detect incorrect SDRAM.	Contact your InfoPrint Solutions Company service representative.
B47 ERROR: SDRAM LARGER THAN 256M*	No	Printer boot initialization tests detect incorrect SDRAM.	Contact your InfoPrint Solutions Company service representative.

Table 11. Fault Messages (continued)

Fault Message	Operator Correctable?	Explanation	Solution
B49 ERROR: SDRAM # LOGICAL BANKS*	No	Printer boot initialization tests detect incorrect SDRAM.	Contact your InfoPrint Solutions Company service representative.
B50 ERROR: SDRAM LOGIC COMB BANKS*	No	Printer boot initialization tests detect incorrect SDRAM.	Contact your InfoPrint Solutions Company service representative.
CALIBRATE TRANSPORT PRESS ENTER KEY*	N/A	If the CDP system detects the installation of a new transporter, an autocalibration cycle initializes.	No action required.
CALIBRATING TRANSPORT PLEASE WAIT...	N/A	Status message: displays when the Transport calibration starts.	No action required.
CALIBRATION ERROR SEE USER'S MANUAL	No	This fault appears if the calibration values stored in the printer are no longer valid.	Contact your InfoPrint Solutions Company service representative.
CLEARING PROGRAM FROM FLASH	N/A	Status message: emulation software successfully loaded into printer RAM and the checksum matched. The old program is now being deleted from flash memory.	No action required.
DIAGNOSTIC PASSED	N/A	Status message: the printer passed its memory and hardware initialization tests.	No action required.
DO NOT POWER OFF DOWNLOADING %%	N/A	Status message: the new emulation program is loading into printer RAM. XX% indicates how much of the program has loaded.	No action required.
DP FIFO BUSY*	No	There is a timing problem in the Engine Controller firmware.	Contact your InfoPrint Solutions Company service representative.
DRIVER CIRCUIT BAD SEE USER'S MANUAL	No	The hammer coil count test failed.	Contact your InfoPrint Solutions Company service representative.
E00 EXE @ ADDR0 SEE USER'S MANUAL	Yes	An illegal or unsupported instruction was attempted in the application program.	<ol style="list-style-type: none"> 1. Cycle Power. Run the print job again. If the message appears, load the latest emulation software. 2. Cycle power. Run the print job again. If the message appears, record the display message and send it to your next higher support facility.

Table 11. Fault Messages (continued)

Fault Message	Operator Correctable?	Explanation	Solution
E01A TYPE 0x40 SEE USER'S MANUAL	Yes	An illegal or unsupported instruction was attempted in the application program.	<ol style="list-style-type: none"> 1. Cycle Power. Run the print job again. If the message appears, load the latest emulation software. 2. Cycle power. Run the print job again. If the message appears, record the display message and send it to your next higher support facility.
E01B TYPE 0x60 SEE USER'S MANUAL	Yes	An illegal or unsupported instruction was attempted in the application program.	<ol style="list-style-type: none"> 1. Cycle Power. Run the print job again. If the message appears, load the latest emulation software. 2. Cycle power. Run the print job again. If the message appears, record the display message and send it to your next higher support facility.
E02 MACHINE CHK SEE USER'S MANUAL	Yes	An illegal or unsupported instruction was attempted in the application program.	<ol style="list-style-type: none"> 1. Cycle Power. Run the print job again. If the message appears, load the latest emulation software. 2. Cycle power. Run the print job again. If the message appears, record the display message and send it to your next higher support facility.
E03A DSI HASH L SEE USER'S MANUAL	Yes	An illegal or unsupported instruction was attempted in the application program.	<ol style="list-style-type: none"> 1. Cycle Power. Run the print job again. If the message appears, load the latest emulation software. 2. Cycle power. Run the print job again. If the message appears, record the display message and send it to your next higher support facility.
E03B DSI HASH S SEE USER'S MANUAL	Yes	An illegal or unsupported instruction was attempted in the application program.	<ol style="list-style-type: none"> 1. Cycle Power. Run the print job again. If the message appears, load the latest emulation software. 2. Cycle power. Run the print job again. If the message appears, record the display message and send it to your next higher support facility.

Table 11. Fault Messages (continued)

Fault Message	Operator Correctable?	Explanation	Solution
E03C DSI BAT PL SEE USER'S MANUAL	Yes	An illegal or unsupported instruction was attempted in the application program.	<ol style="list-style-type: none"> 1. Cycle Power. Run the print job again. If the message appears, load the latest emulation software. 2. Cycle power. Run the print job again. If the message appears, record the display message and send it to your next higher support facility.
E03D DSI BAT PS SEE USER'S MANUAL	Yes	An illegal or unsupported instruction was attempted in the application program.	<ol style="list-style-type: none"> 1. Cycle Power. Run the print job again. If the message appears, load the latest emulation software. 2. Cycle power. Run the print job again. If the message appears, record the display message and send it to your next higher support facility.
E03E DSI CXIWX SEE USER'S MANUAL	Yes	An illegal or unsupported instruction was attempted in the application program.	<ol style="list-style-type: none"> 1. Cycle Power. Run the print job again. If the message appears, load the latest emulation software. 2. Cycle power. Run the print job again. If the message appears, record the display message and send it to your next higher support facility.
E03F DSI CXOWX SEE USER'S MANUAL	Yes	An illegal or unsupported instruction was attempted in the application program.	<ol style="list-style-type: none"> 1. Cycle Power. Run the print job again. If the message appears, load the latest emulation software. 2. Cycle power. Run the print job again. If the message appears, record the display message and send it to your next higher support facility.
E03G DSI ECXIWX SEE USER'S MANUAL	Yes	An illegal or unsupported instruction was attempted in the application program.	<ol style="list-style-type: none"> 1. Cycle Power. Run the print job again. If the message appears, load the latest emulation software. 2. Cycle power. Run the print job again. If the message appears, record the display message and send it to your next higher support facility.

Table 11. Fault Messages (continued)

Fault Message	Operator Correctable?	Explanation	Solution
E03H DSI ECXOWX SEE USER'S MANUAL	Yes	An illegal or unsupported instruction was attempted in the application program.	<ol style="list-style-type: none"> 1. Cycle Power. Run the print job again. If the message appears, load the latest emulation software. 2. Cycle power. Run the print job again. If the message appears, record the display message and send it to your next higher support facility.
E04A ISI NO TRA SEE USER'S MANUAL	Yes	An illegal or unsupported instruction was attempted in the application program.	<ol style="list-style-type: none"> 1. Cycle Power. Run the print job again. If the message appears, load the latest emulation software. 2. Cycle power. Run the print job again. If the message appears, record the display message and send it to your next higher support facility.
E04B ISI DIRECT SEE USER'S MANUAL	Yes	An illegal or unsupported instruction was attempted in the application program.	<ol style="list-style-type: none"> 1. Cycle Power. Run the print job again. If the message appears, load the latest emulation software. 2. Cycle power. Run the print job again. If the message appears, record the display message and send it to your next higher support facility.
E04C ISI PROTEC SEE USER'S MANUAL	Yes	An illegal or unsupported instruction was attempted in the application program.	<ol style="list-style-type: none"> 1. Cycle Power. Run the print job again. If the message appears, load the latest emulation software. 2. Cycle power. Run the print job again. If the message appears, record the display message and send it to your next higher support facility.
E06 NOT ALIGNED SEE USER'S MANUAL	Yes	An illegal or unsupported instruction was attempted in the application program.	<ol style="list-style-type: none"> 1. Cycle Power. Run the print job again. If the message appears, load the latest emulation software. 2. Cycle power. Run the print job again. If the message appears, record the display message and send it to your next higher support facility.

Table 11. Fault Messages (continued)

Fault Message	Operator Correctable?	Explanation	Solution
E07 ILLEGAL INS SEE USER'S MANUAL	Yes	An illegal or unsupported instruction was attempted in the application program.	<ol style="list-style-type: none"> 1. Cycle Power. Run the print job again. If the message appears, load the latest emulation software. 2. Cycle power. Run the print job again. If the message appears, record the display message and send it to your next higher support facility.
E08 FLOATINGPNT SEE USER'S MANUAL	Yes	An illegal or unsupported instruction was attempted in the application program.	<ol style="list-style-type: none"> 1. Cycle Power. Run the print job again. If the message appears, load the latest emulation software. 2. Cycle power. Run the print job again. If the message appears, record the display message and send it to your next higher support facility.
E12 SYSTEM CALL SEE USER'S MANUAL	Yes	An illegal or unsupported instruction was attempted in the application program.	<ol style="list-style-type: none"> 1. Cycle Power. Run the print job again. If the message appears, load the latest emulation software. 2. Cycle power. Run the print job again. If the message appears, record the display message and send it to your next higher support facility.
E13 TRACE INT SEE USER'S MANUAL	Yes	An illegal or unsupported instruction was attempted in the application program.	<ol style="list-style-type: none"> 1. Cycle Power. Run the print job again. If the message appears, load the latest emulation software. 2. Cycle power. Run the print job again. If the message appears, record the display message and send it to your next higher support facility.
E16 ITRANS MISS SEE USER'S MANUAL	Yes	An illegal or unsupported instruction was attempted in the application program.	<ol style="list-style-type: none"> 1. Cycle Power. Run the print job again. If the message appears, load the latest emulation software. 2. Cycle power. Run the print job again. If the message appears, record the display message and send it to your next higher support facility.

Table 11. Fault Messages (continued)

Fault Message	Operator Correctable?	Explanation	Solution
E17 DLOAD MISS SEE USER'S MANUAL	Yes	An illegal or unsupported instruction was attempted in the application program.	<ol style="list-style-type: none"> 1. Cycle Power. Run the print job again. If the message appears, load the latest emulation software. 2. Cycle power. Run the print job again. If the message appears, record the display message and send it to your next higher support facility.
E18 DSTORE MISS SEE USER'S MANUAL	Yes	An illegal or unsupported instruction was attempted in the application program.	<ol style="list-style-type: none"> 1. Cycle Power. Run the print job again. If the message appears, load the latest emulation software. 2. Cycle power. Run the print job again. If the message appears, record the display message and send it to your next higher support facility.
E19 BREAKPOINT SEE USER'S MANUAL	Yes	An illegal or unsupported instruction was attempted in the application program.	<ol style="list-style-type: none"> 1. Cycle Power. Run the print job again. If the message appears, load the latest emulation software. 2. Cycle power. Run the print job again. If the message appears, record the display message and send it to your next higher support facility.
E20 SYS MANAGE SEE USER'S MANUAL	Yes	An illegal or unsupported instruction was attempted in the application program.	<ol style="list-style-type: none"> 1. Cycle Power. Run the print job again. If the message appears, load the latest emulation software. 2. Cycle power. Run the print job again. If the message appears, record the display message and send it to your next higher support facility.
E30 DEBUGGER SEE USER'S MANUAL	Yes	An illegal or unsupported instruction was attempted in the application program.	<ol style="list-style-type: none"> 1. Cycle Power. Run the print job again. If the message appears, load the latest emulation software. 2. Cycle power. Run the print job again. If the message appears, record the display message and send it to your next higher support facility.

Table 11. Fault Messages (continued)

Fault Message	Operator Correctable?	Explanation	Solution
E31A EVENT O BP SEE USER'S MANUAL	Yes	An illegal or unsupported instruction was attempted in the application program.	<ol style="list-style-type: none"> 1. Cycle Power. Run the print job again. If the message appears, load the latest emulation software. 2. Cycle power. Run the print job again. If the message appears, record the display message and send it to your next higher support facility.
E31B EVENT 1 BP SEE USER'S MANUAL	Yes	An illegal or unsupported instruction was attempted in the application program.	<ol style="list-style-type: none"> 1. Cycle Power. Run the print job again. If the message appears, load the latest emulation software. 2. Cycle power. Run the print job again. If the message appears, record the display message and send it to your next higher support facility.
E31C EVENT 2 BP SEE USER'S MANUAL	Yes	An illegal or unsupported instruction was attempted in the application program.	<ol style="list-style-type: none"> 1. Cycle Power. Run the print job again. If the message appears, load the latest emulation software. 2. Cycle power. Run the print job again. If the message appears, record the display message and send it to your next higher support facility.
E31D EVENT 3 BP SEE USER'S MANUAL	Yes	An illegal or unsupported instruction was attempted in the application program.	<ol style="list-style-type: none"> 1. Cycle Power. Run the print job again. If the message appears, load the latest emulation software. 2. Cycle power. Run the print job again. If the message appears, record the display message and send it to your next higher support facility.
E31E EVENT 4 BP SEE USER'S MANUAL	Yes	An illegal or unsupported instruction was attempted in the application program.	<ol style="list-style-type: none"> 1. Cycle Power. Run the print job again. If the message appears, load the latest emulation software. 2. Cycle power. Run the print job again. If the message appears, record the display message and send it to your next higher support facility.

Table 11. Fault Messages (continued)

Fault Message	Operator Correctable?	Explanation	Solution
E31F EVENT 5 BP SEE USER'S MANUAL	Yes	An illegal or unsupported instruction was attempted in the application program.	<ol style="list-style-type: none"> 1. Cycle Power. Run the print job again. If the message appears, load the latest emulation software. 2. Cycle power. Run the print job again. If the message appears, record the display message and send it to your next higher support facility.
E31G EVENT 6 BP SEE USER'S MANUAL	Yes	An illegal or unsupported instruction was attempted in the application program.	<ol style="list-style-type: none"> 1. Cycle Power. Run the print job again. If the message appears, load the latest emulation software. 2. Cycle power. Run the print job again. If the message appears, record the display message and send it to your next higher support facility.
E31H EVENT 7 BP SEE USER'S MANUAL	Yes	An illegal or unsupported instruction was attempted in the application program.	<ol style="list-style-type: none"> 1. Cycle Power. Run the print job again. If the message appears, load the latest emulation software. 2. Cycle power. Run the print job again. If the message appears, record the display message and send it to your next higher support facility.
E32A CND 0 BP SEE USER'S MANUAL	Yes	An illegal or unsupported instruction was attempted in the application program.	<ol style="list-style-type: none"> 1. Cycle Power. Run the print job again. If the message appears, load the latest emulation software. 2. Cycle power. Run the print job again. If the message appears, record the display message and send it to your next higher support facility.
E32B CND 1 BP SEE USER'S MANUAL	Yes	An illegal or unsupported instruction was attempted in the application program.	<ol style="list-style-type: none"> 1. Cycle Power. Run the print job again. If the message appears, load the latest emulation software. 2. Cycle power. Run the print job again. If the message appears, record the display message and send it to your next higher support facility.

Table 11. Fault Messages (continued)

Fault Message	Operator Correctable?	Explanation	Solution
E32C CND 2 BP SEE USER'S MANUAL	Yes	An illegal or unsupported instruction was attempted in the application program.	<ol style="list-style-type: none"> 1. Cycle Power. Run the print job again. If the message appears, load the latest emulation software. 2. Cycle power. Run the print job again. If the message appears, record the display message and send it to your next higher support facility.
E32D CND 3 BP SEE USER'S MANUAL	Yes	An illegal or unsupported instruction was attempted in the application program.	<ol style="list-style-type: none"> 1. Cycle Power. Run the print job again. If the message appears, load the latest emulation software. 2. Cycle power. Run the print job again. If the message appears, record the display message and send it to your next higher support facility.
E32E CND 4 BP SEE USER'S MANUAL	Yes	An illegal or unsupported instruction was attempted in the application program.	<ol style="list-style-type: none"> 1. Cycle Power. Run the print job again. If the message appears, load the latest emulation software. 2. Cycle power. Run the print job again. If the message appears, record the display message and send it to your next higher support facility.
E32F CND 5 BP SEE USER'S MANUAL	Yes	An illegal or unsupported instruction was attempted in the application program.	<ol style="list-style-type: none"> 1. Cycle Power. Run the print job again. If the message appears, load the latest emulation software. 2. Cycle power. Run the print job again. If the message appears, record the display message and send it to your next higher support facility.
E32G CND 6 BP SEE USER'S MANUAL	Yes	An illegal or unsupported instruction was attempted in the application program.	<ol style="list-style-type: none"> 1. Cycle Power. Run the print job again. If the message appears, load the latest emulation software. 2. Cycle power. Run the print job again. If the message appears, record the display message and send it to your next higher support facility.

Table 11. Fault Messages (continued)

Fault Message	Operator Correctable?	Explanation	Solution
E32H CND 7 BP SEE USER'S MANUAL	Yes	An illegal or unsupported instruction was attempted in the application program.	<ol style="list-style-type: none"> 1. Cycle Power. Run the print job again. If the message appears, load the latest emulation software. 2. Cycle power. Run the print job again. If the message appears, record the display message and send it to your next higher support facility.
E33 WRITE BP SEE USER'S MANUAL	Yes	An illegal or unsupported instruction was attempted in the application program.	<ol style="list-style-type: none"> 1. Cycle Power. Run the print job again. If the message appears, load the latest emulation software. 2. Cycle power. Run the print job again. If the message appears, record the display message and send it to your next higher support facility.
E34 TRACE CMLPT SEE USER'S MANUAL	Yes	An illegal or unsupported instruction was attempted in the application program.	<ol style="list-style-type: none"> 1. Cycle Power. Run the print job again. If the message appears, load the latest emulation software. 2. Cycle power. Run the print job again. If the message appears, record the display message and send it to your next higher support facility.
E99 UNKNOWN INT SEE USER'S MANUAL	Yes	An illegal or unsupported instruction was attempted in the application program.	<ol style="list-style-type: none"> 1. Cycle Power. Run the print job again. If the message appears, load the latest emulation software. 2. Cycle power. Run the print job again. If the message appears, record the display message and send it to your next higher support facility.
E NET TEST UNAVAILABLE	Yes	The Ethernet PCBA is not enabled or did not initialize correctly.	Cycle power. Wait for "E Net Ready" to display, then retry operation. If the fault message appears again, contact your InfoPrint Solutions Company service representative.
ENERGY SAVER MODE ACTIVE	N/A	Status message: printer is in low-energy idle state, all fans and higher voltages are off, only +5Vdc logic circuits are active.	No action required. Note: If the printer was in NOT READY state when the energy saver mode was activated, it will remain in the NOT READY state until the START key is pressed.

Table 11. Fault Messages (continued)

Fault Message	Operator Correctable?	Explanation	Solution
ERROR: DC PROGRAM NOT VALID	Yes	The printer cannot find the data controller program or the validation checksum is corrupt.	Download the program again. If the fault message appears again, contact your InfoPrint Solutions Company service representative.
ERROR: EC STOPPED AT STATE XXXX	No	XXXX is the number from 0000 to 0010. The Engine Controller has stopped and is in the state identified by the number displayed.	Contact your InfoPrint Solutions Company service representative.
FREEFORM OFF	Yes	A control panel key is stuck in the down position.	<ol style="list-style-type: none"> 1. Release stuck keys. Determined and correct what made the key(s) stick. 2. Cycle power: power off the printer, wait 15 seconds, power on the printer. If the message appears, replace the control panel.
FREEFORM ON:OFF HOLD KEY @ PWRUP	Yes	This message appears if the FREEFORM feature is enabled. This feature is for manufacturing use only and is never used by the customer or field maintenance personnel.	<ol style="list-style-type: none"> 1. Power off the printer. Hold any control panel key down and power on the printer. Hold the key down until the printer powers up and the message FREEFORM OFF appears on the LCD. If the message reappears, contact your InfoPrint Solutions Company service representative.
H00: PCI SLOT ? SEE USER'S MANUAL	No	The controller board is not communicating with a PCI card. This could indicate a bad PCI card, poor connection, or problem in the PCI bus.	Contact your InfoPrint Solutions Company service representative.
H01: PCI J12 SEE USER'S MANUAL	No	The controller board is not communicating with the PCI card in PCI slot J12. This could indicate a bad PCI card, poor connection, or problem in the PCI bus.	Contact your InfoPrint Solutions Company service representative.
H02: PCI J13 SEE USER'S MANUAL	No	The controller board is not communicating with the PCI card in PCI slot J13. This could indicate a bad PCI card, poor connection, or problem in the PCI bus.	Contact your InfoPrint Solutions Company service representative.

Table 11. Fault Messages (continued)

Fault Message	Operator Correctable?	Explanation	Solution
H/B CONTROL MODE SEE USER'S MANUAL	N/A	A status message indicating that one or more hammer coils are hotter than normal and the printer will run in half-speed mode until they cool down. This can occur during especially dense print jobs.	None required. The printer automatically corrects the condition by running at half-speed mode until the hammers cool down, at which point it resumes full speed printing.
HMR BANK NOT INSTALLED SEE USER'S MANUAL	No	Hammer bank is not installed.	Contact your InfoPrint Solutions Company service representative.
HAMMER COIL BAD #, #, #, #,...etc.	No	Hammer coils(s) number #, #, etc. failed the current test at power-up.	(You can continue to print with degraded print quality.) Contact your InfoPrint Solutions Company service representative.
ILL INST ACCSS*	Yes	Illegal Instruction Access: a firmware error on the controller board.	Cycle power. Run the print job again. If the message appears, download the emulation software again. If the message appears, contact your InfoPrint Solutions Company service representative.
INCOMPAT E-NET	Yes	Incompatible Ethernet interface card is installed.	Install a compatible Ethernet interface card to the printer then reboot. If this message still appears, contact your InfoPrint Solutions Company service representative.
INTAKE FAN FAULT	Yes	Sensors cannot detect current in fan circuit.	See description for HMR BANK FAN FLT.
INTERRUPT UNUSED VECTOR 00	No	The controller board receives an interrupt it does not understand.	Cycle power. If this message occurred once and never again, you can ignore it. If the message reappears or appears consistently, contact your InfoPrint Solutions Company service representative.
LOADING PROGRAM FROM PORT XX%	N/A	The new emulation program is loading into printer RAM. XX% indicates how much of the program has loaded.	No action required.
LOADING PROGRAM INTO FLASH	N/A	The printer has deleted the previous program from flash memory and is loading the new program into flash memory.	No action required.
NOT READY	N/A	Printer state message: printer is offline, not in communication with host.	No action necessary.

Table 11. Fault Messages (continued)

Fault Message	Operator Correctable?	Explanation	Solution
ONLINE CU TIMED OUT	No	Controller unit timed out.	Contact your InfoPrint Solutions Company service representative.
OPERATOR MENU <first menu item>	N/A	Non-error status message.	No action necessary.
OPERATOR MENU LOCKED	N/A	Non-error status message.	No action necessary.
OPERATOR MENU UNLOCKED	N/A	Non-error status message.	No action necessary.
P00 ERROR:SYSTEM FAULT	Yes	Firmware error on the controller board.	Cycle power. Run the print job again. If the message appears, download the emulation software again. If the message appears again, contact your InfoPrint Solutions Company service representative.
P05 DIAGNOSTIC TEST PASSED	N/A	Non-error status message.	No action required.
P17 SECURITY VIOLATION	No	Security code of PAL™ on controller board does not match code of firmware on the controller board.	Contact your InfoPrint Solutions Company service representative.
PA1 SELECTED	N/A	Attach status message.	No action necessary.
PA2 SELECTED	N/A	Attach status message.	No action necessary.
PAP FD DRVR CIR* SEE USER'S MANUAL	No	Paper Feed Driver Circuit. The paper feed driver circuit on the controller board is drawing too much current.	Contact your InfoPrint Solutions Company service representative.
PRINTER UNDER REMOTE CONTROL	Yes	Indicates that remote management software has control of the printer.	No action necessary
QUEUE OVERRUN	No	In CT Twinax emulation, the print buffer has overflowed.	Contact your InfoPrint Solutions Company service representative.
READY	N/A	Printer state message: printer is online and in communication with host.	No action necessary.
RESETTING...PLEASE WAIT	N/A	Status message: the printer finished loading the program into flash memory and is automatically resetting itself.	No action required.
RESTORING BOOT CODE	N/A	Normal download initialization message.	No action required.
RIBBON INK OUT CHANGE RIBBON	Yes	RibbonMinder has determined that the ribbon is out of ink. Message appears only when the CDP feature has been disabled.	Replace the ribbon and verify ribbon life is reset to 100%.

Table 11. Fault Messages (continued)

Fault Message	Operator Correctable?	Explanation	Solution
SECURITY CODE VIOLATION	No	Security Key does not match emulation.	Contact your InfoPrint Solutions Company service representative.
SECURITY KEY NOT DETECTED	No	The security key is not present or has failed.	Contact your InfoPrint Solutions Company service representative.
SENSOR CALIBRATION PASSED	N/A	Status message: displays when the Transport calibration is successful.	No action required.
SERVICE MENU <first service test>	N/A	Non-error status message.	No action necessary.
SF ERROR	Yes	Structured Field Error. Application software has violated structured data field parameters.	Not a printer problem. Have the system administrator correct applications data or configuration.
SHUT DRVR CIR* SEE USER'S MANUAL	No	The shuttle driver circuit on the controller board is drawing too much current.	Power down and contact your InfoPrint Solutions Company service representative.
SHUTL OVR SPEED*	No	The shuttle is running over speed.	Contact your InfoPrint Solutions Company service representative.
SHUTTLE STALL	Yes	The shuttle is not moving.	Set the platen lever to match the thickness of paper, but not too tightly. Check and adjust the platen gap. Inspect the ink transport media mask for deformation that snags and interferes with shuttle movement. If fault source is not apparent, contact your InfoPrint Solutions Company service representative.
SHUTTLE TYPE NOT SUPPORTED*	No	The shuttle type was not detected at power-up.	Contact your InfoPrint Solutions Company service representative.
STACK UNDERFLOW*	No	Firmware error on the controller board.	Contact your InfoPrint Solutions Company service representative.
TABLE MISMATCH DOWNLOAD AGAIN	Yes	Indicates that the software update has failed and should be reloaded.	Power off the printer. Download the program again from the beginning. If the message appears again, contact your InfoPrint Solutions Company service representative.

Table 11. Fault Messages (continued)

Fault Message	Operator Correctable?	Explanation	Solution
TCP PORT BUSY	No	Error message reported by the Printer Manager when the Ethernet card is installed. The network address given in the printer properties was reached, but the printer port was "busy". When the port setting is "Serial", the printer manager software cannot interact with the Ethernet card, although the card will respond to other TCP/IP utilities.	Refer to the <i>6500 Maintenance Information Manual</i> .
TESTING HARDWARE PLEASE WAIT	N/A	Status message when printer runs self-tests and initialization routines.	No action necessary.
TOP OF FORM SET	N/A	Non-error status message.	No action necessary.
TRANSPORT CALIBRATION COMPLETE	N/A	Status message: displays when Transport calibration is complete.	No action required.
WAITING FOR ETHERNET ADAPTER	N/A	Status message: appears when the printer is first powered on if the Ethernet port is enabled or Ethernet PCI card is installed.	No action required.

Appendix A. Printer Specifications

Ribbon Specifications

Note: The ribbon life is based on InfoPrint Solutions Company tests conducted in accordance with ANSI Standard X3A.182. Actual ribbon life may vary depending upon the user quality criteria, printer condition, machine settings, paper quality, and bar code requirements. Label yield depends on label format, bar code symbology, and other parameters. Label yield with high-performance scanning equipment may exceed these yields. Use only the ribbons listed below.

P/N	Description	Length (Yards)
41U1680	Ribbon, 6pk, InfoPrint Solutions Company, 6500	100

Ordering Ribbons

6500-vxx Models

InfoPrint Solutions Company Printing Supplies are distributed through Priority Fulfillment Services (PSFweb) and a worldwide network of dealers. Please contact one of the following numbers to place an order for InfoPrint Solutions Company 6500 ribbons or to locate an InfoPrint Solutions Company Printing Supplies Dealer in your area:

United States and Canada

888-IBM-PRINT (888-426-7746)

Asia Pacific

Australia	132 426
Bangladesh	65-320 1631
Brunei	65-320 1631
Cambodia	65-320 1631
China	63-614-874
Hong Kong	852-2825-7878
India	91-22-8200-456
Indonesia	62-21-523-8153
Korea	82-2-3781-7761
Laos	65-320 1631
Malaysia	6-03-7785-115
Myanmar	65-320 1631
New Zealand	0800 810800
Philippines	63-2-819-2307
Singapore	65-6418-1558
Sri Lanka	65-320 1631
Taiwan	866-2-27258888-9517
Thailand	66-2-273-4631
Vietnam	65-320 1631

Latin America

888-426-7746

Europe, Middle East, and Africa

32-4364-4111

Call Toll Free

Belgium	0800 71950
Denmark	800 15534
Finland	08001-13112
France	0800-905871
Germany	0800 18 18 005
Ireland	900-983131
Italy	800 878349
Norway	800-11389
Sweden	0207 94270
UK	0800 968679

Priority Fulfillment Service (PFS)

500 North Central Expressway
Plano, TX 75074
Fax: (972) 881-9201

Warranty Information

The approximate average yields are not a warranty or guarantee of minimum life and are provided to assist in initial supplies planning. Actual usage should be used to establish the supply's life in the end user's application. Many factors such as print coverage per page, machine settings, paper type and size, and environmental conditions can affect supply life.

Supply warranties are only for defects in materials and workmanship at the time of shipment and installation. They are not for print count life or normal wear and tear, nor for any print count minimum. Contact your place of purchase for warranty return instructions.

Paper Specifications

The following paper specifications are general guidelines. Paper stock should be tested with applications to determine print quality.

Paper

Type	<ul style="list-style-type: none"> • Edge-perforated, fan-fold, 3 to 17 inches (7.62 to 43.18 cm) wide*, 3 to 16 inches with stacker, 2 to 24 inches (5.08 to 60.96 cm) long**, 5 to 12 inches with stacker. • Single-part: 15 pound (57 g/m²) to 100 pound (377 g/m²) stock. • Multi-part carbon: 1 to 6 part forms, maximum 12 pound (45 g/m²) ply of upper plies. • Multi-part carbonless, maximum of 6-part forms. Test readability of greater than 4-part forms. • Recycled paper not recommended with stacker. 	
Sheet Thickness	0.025 inches (0.064 cm) maximum	
Drive	Adjustable tractors (6-pin engagement)	
Slew Rate	Fast	Slow
6500-v05	12 ips	10.4 ips
6500-v5P	12 ips	10.4 ips
6500-v10	20 ips	10.4 ips
6500-v10 w/Stacker	20 ips	10.4 ips
6500-v1P	16 ips	10.4 ips
6500-v15	25 ips	10.4 ips
6500-v15 w/Stacker	25 ips	10.4 ips
6500-v20 w/Stacker	36 ips	18 ips
6500-v20	36 ips	18 ips

Labels

- On Backing:** One-part continuous perforated fan-fold back form. Labels must be placed at least 1/6 inch (0.42 cm) from the fan-fold perforation. Backing adhesive must not be squeezed out during printing.
- Sheet Size:** 3 to 17 inches (7.62 to 43.18 cm) wide*, including the two standard perforated tractor feed strips. A maximum sheet length of 16 inches (40.64 cm) between top and bottom perforations.**
- Thickness:** Not to exceed 0.025-inch (0.064 cm), including backing sheet.

*On pedestal models, when using the rear paper exit, the maximum form width is 16 inches (40.64 cm).

**On cabinet models, forms longer than 12 inches can be used by opening the front and rear printer doors.

Printer Dimensions and Weight

Cabinet Models

- Height:** 41 inches (103.3 cm)
- Width:** 27 inches (68.6 cm)
- Depth:** 29 inches (73.7 cm)
- Weight:**
- 225 lbs. (102.1 kg) unpackaged
 - 237 lbs. (112. kg) unpackaged with power stacker
 - 285 lbs. (129.3 kg) packaged
 - 297 lbs. (139 kg) packaged with power stacker

Pedestal Models

- Height:** 35.5 inches (90.2 cm)
- Width:** 24.6 inches (62.5 cm)
- Depth:** 30 inches (76.2 cm)
- Weight:**
- 120 pounds. (54.4 kg) unpackaged
 - 160 pounds. (72.6 kg) packaged

Environmental Characteristics

Temperature

Operating: 50° to 104° F (10° to 40°C) up to 5000 feet (1524 meters), 50° to 90° F (10° to 32°C) up to 8000 feet (2438 meters)

Storage: -40° to 158° F (- 40° to 70°C)

Relative Humidity

Operating: 15% to 80% (noncondensing)

Storage: 15% to 90% (noncondensing)

Acoustic Noise Level

	Cabinet Models			Pedestal Models	
Acoustic Noise Levels per ISO 9296	-v05 -v10	-v15	-v20	-v5P	-v1P
Printing	50 dB	52 dB	55 dB	62 dB	66 dB
	6.7 Bel	7.0 Bel	7.1 Bel	7.8 Bel	8.2 Bel
Standby	46 dB	46 dB	42 dB	46 dB	46 dB
	6.3 Bel	6.3 Bel	5.8 Bel	6.3 Bel	6.3 Bel
Note: Cabinet model noise levels listed are with the cabinet doors closed. Levels will be higher if the doors are open.					
Pedestal model noise levels listed are for rear paper exit. Levels will be higher for top paper exit.					

Electrical Characteristics

Input Voltage

Line Voltage Design Range	Line Frequency	RMS Current			
		500 LPM	1000 LPM	1500 LPM	2000 LPM
88-140 V RMS	47-63 Hz	6A @ 100 V	6A @ 100 V	8A @ 100 V	9A @ 100V
178-270 V RMS	47-63 Hz	3A @ 200 V	3A @ 200 V	5A @ 200 V	9A @ 100V

Power Consumption

6500-v05

6500-v5P

120 VAC 60 Hz	Operating DP Mode		Standby	
	All H's	ECMA132*	Not Energy Star	Energy Star
Watts	210	167	80	21
BTU/Hour	717	570	273	75
VA	300	291	120	36

220 VAC 60 Hz	Operating DP Mode		Standby	
	All H's	ECMA132*	Not Energy Star	Energy Star
Watts	210	176	80	22
BTU/Hour	717	601	273	75
VA	340	194	130	41

*ECMA132 Standard Spread Sheet Pattern (ISO 10561)

6500-v10
6500-v1P

120 VAC 60 Hz	Operating DP Mode		Standby	
	All H's	ECMA132*1	Not Energy Star	Energy Star
Watts	300	197	80	25
BTU/Hour	1025	673	273	85
VA	530	342	140	48

220 VAC 60 Hz	Operating DP Mode		Standby	
	All H's	ECMA132*	Not Energy Star	Energy Star
Watts	290	198	80	25
BTU/Hour	990	676	273	85
VA	600	227	150	55

6500-v15

120 VAC 60 Hz	Operating DP Mode		Standby	
	All H's	ECMA132*	Not Energy Star	Energy Star
Watts	440	231	90	27
BTU/Hour	1502	788	307	92
VA	740	388	160	50

*ECMA132 Standard Spread Sheet Pattern (ISO 10561)

220 VAC 60 Hz	Operating DP Mode		Standby	
	All H's	ECMA132*	Not Energy Star	Energy Star
Watts	420	243	90	27
BTU/Hour	1434	829	307	92
VA	830	277	170	58

6500-v20

120 VAC 60 Hz	Operating DP Mode		Standby	
	All H's	ECMA132*	Not Energy Star	Energy Star
Watts	637	251	119	28
BTU/Hour	2175	857	406	95.6
VA	690	291	120	30.7

220 VAC 60 Hz	Operating DP Mode		Standby	
	All H's	ECMA132*	Not Energy Star	Energy Star
Watts	604	268	111	28
BTU/Hour	2062	915	379	95.6
VA	686	280	122	30.7

*ECMA132 Standard Spread Sheet Pattern (ISO 10561)

Interfaces

Type	Standard	IEEE 1284 Parallel, Centronics Parallel, RS-232/RS-422 Serial (optional), Dataproducts Parallel.
	Optional	Coax, Twinax, Dataproducts Long Line, Ethernet 10/100Base-T
Logic Levels	TTL/EIA-232-E, EIA-422-B	
Data Format:	ASCII	
Compatibility	EIA-232-E, EIA-422-B, PC Parallel, Dataproducts, IEEE 1284, Twinax, Coax, Ethernet	
Transfer Rates	Up to 200K bytes/sec on parallel interfaces Up to 19.2 K baud on RS-232 serial interface Up to 115.2K baud on RS-422 serial interface	
Buffer	16 kilobytes on serial interfaces 16 kilobytes on parallel interfaces	

Cables

A power line cord is provided with the printer, but no data cables. The following provides data cable requirements and ordering information.

ASCII Serial/Parallel: The 6500 printer is connected to personal computers and controllers via industry standard EIA-232-E and PC-parallel printer cables. For Dataproducts interfaces, you will need to obtain a Dataproducts cable. Contact your InfoPrint Solutions Company service representative to order the following:

- EIA-232-E Cable
- PC-Parallel Cable
- Dataproducts Adapter Feature

System i: The 6500 is connected to the System i ASCII Workstation Controller via the following InfoPrint Solutions Company cables, available through your InfoPrint Solutions Company service representative:

- 20 ft. RS-232
- 40 ft. RS-232

RISC System/6000®: For RS-232 attachment to the IBM RISC System/6000, the following are required:

- Async cable EIA-232/V.24
- Printer/terminal interposer EIA-232
- Serial Cable Kit (PN 12H1204)

Coax/Twinax Interface Feature: Contact your InfoPrint Solutions Company service representative for attachment requirements.

Printing Rates

The printing speed of text is measured in lines per minute (lpm), and is a function of the selected font and the vertical dot density. Printing speed is independent of the number of characters configured in the character set repertoire. Print rates for lines containing attributes such as bold or emphasized printing, superscripts, subscripts, or elongated attributes will decrease to not less than half the rates of the font without such attributes. The exact print rate of lines containing these attributes depends on the specific print job, but software maximizes the throughput by dynamically determining which dot rows contain adjacent dots and must be printed in two strokes. Table 12 lists typical printing rates.

The reverse paper feed capability allows the printing of multiple densities on a single line. This is useful in printing forms and text together or in mixing different fonts on a print line. Use of multiple densities and reverse paper feed also affects throughput.

Table 12. 6500 Nominal Print Rates (1 of 2)

PRINT QUALITY DOT DENSITY (DPI) Note 1	CHARACTERS PER INCH	DOT MATRIX Note 2	PERFORMANCE							
			Uppercase Only LPM				Descenders & Underline LPM			
			500	1000	1500	2000s	500	1000	1500	2000s
CORRESPONDENCE 90 (180) x 96	10	7(13) x 9+3	200	400	600	842	500	306	459	648
	12	6(11) x 9+3								
	15	(9) x 9+3								
DATA PROCESSING 60(120) x 72	10	5(9) x 7+2	375	750	1125	1500	300	600	900	1200
	12	4(7) x 7+2								
	13.3	4(7) x 7+2								
	15	3(5) x 7+2								
HIGH SPEED 60(120) x 48	10	5(9) x 5+1	500	1000	1500	2000	428	865	1284	1714
	12	4(7) x 5+1								
	13.3	4(7) x 5+1								
Note 1	A (B) x C, where:		A is maximum horizontal dot density B is horizontal dot placement density C is vertical dot density							
Note 2	D (E) x F + G, where:		D is maximum number of dots that may be placed on E horizontal positions F is number of vertical dots for uppercase symbols G is number of dots available for descenders							

Table 13. 6500 Nominal Print Rates (2 of 2)

PRINT QUALITY DOT DENSITY (DPI) Note 1	CHARACTERS PER INCH	DOT MATRIX Note 2	PERFORMANCE			
			Plot Mode IPM			
			500	1000	1500	2000
CORRESPONDENCE 90 (180) x 96	10	7(13) x 9+3	21	42	61	87
	12	6(11) x 9+3				
	15	(9) x 9+3				

Table 13. 6500 Nominal Print Rates (2 of 2) (continued)

PRINT QUALITY DOT DENSITY (DPI) Note 1	CHARACTERS PER INCH	DOT MATRIX Note 2	PERFORMANCE			
			Plot Mode IPM			
			500	1000	1500	2000
DATA PROCESSING 60(120) x 72	10 12 13.3 15 17.1	5(9) x 7+2 4(8) x 7+2 4(8) x 7+2 3(5) x 7+2 3(5) x 7+2	42	83	127	167
HIGH SPEED 60(120) x 48	10 12 13.3	5(9) x 5+1 4(7) x 5+1 4(7) x 5+1	62	124	186	250
Note 1	A (B) x C, where:		A is maximum horizontal dot density B is horizontal dot placement density C is vertical dot density			
Note 2	D (E) x F + G, where:		D is maximum number of dots that may be placed on E horizontal positions F is number of vertical dots for uppercase symbols G is number of dots available for descenders			

Appendix B. A Quick Look at Line Matrix Printing

Character Formation

The InfoPrint 6500 is an impact printer: it creates characters by printing ink dots on paper. Dots overlap to produce a solid-appearing character of uniform density. The dots are made by an assembly of steel hammers mounted on a rapidly oscillating shuttle. The hammers strike the paper through a moving ink ribbon. The dot patterns of characters are mapped in printer memory on invisible matrices, as shown in Figure 72.

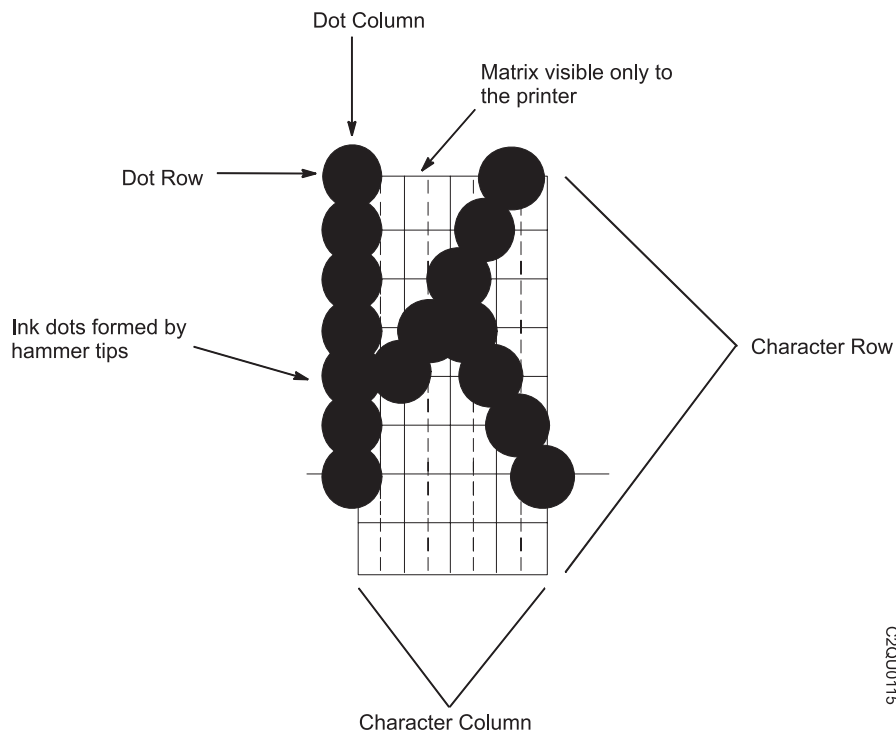

C29U0115

Figure 72. Typical Character Formation

Serial matrix printers use a moving printhead with pins to form single characters sequentially along the printed line. Unlike serial matrix printers, line matrix printers divide every printable line into horizontal dot rows, then print a dot row of the entire line at every lateral sweep of the shuttle.

During each sweep of the shuttle, hammers are activated to print dots at the required positions in the dot row. When the shuttle reaches the end of a sweep, it reverses direction, and the paper advances one dot row. The hammers print the next row of dots as the shuttle sweeps in the opposite direction, as shown in Figure 73, unless unidirectional printing is chosen.

After a line of characters is printed, the paper advances to the first dot row of the next print line. This creates a number of blank rows between lines of characters, depending on the print mode and line spacing you selected.

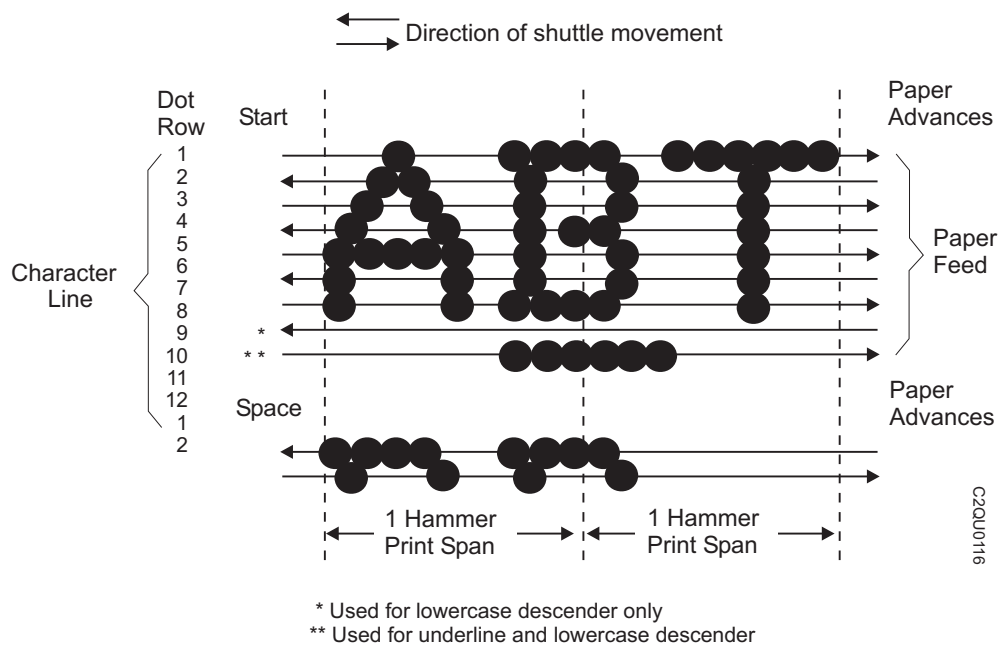

Figure 73. Line Matrix Printing

Printing Speed

The speed of text printing is measured in lines per minute (lpm). This speed is dependent upon the number of dot rows required to produce a line of characters, regardless of the number of characters in the line. Because more dot rows are required to print lowercase characters with descenders, those character lines will print at a fractionally lower rate.

In addition to character printing, the printer can plot dot-addressable graphic images. The speed of graphics plotting is measured in inches per minute (ipm). Unidirectional plotting can produce better print quality and takes about twice as long as bidirectional plotting. You can select either plotting mode from the operator panel or from the host computer.

Printing rates also vary according to the print quality you select. For example, if you select the Near Letter Quality (NLQ) option, the printer uses more dot rows and slower print strokes to form characters than if you choose the Draft Quality option. Character formation and print speed are faster in Draft Quality because the printer uses fewer dot rows to form characters.

Printing rates are listed in Appendix A, "Printer Specifications," on page 251.

Appendix C. Host Attachment

The following paragraphs provide information that will help you plan your attachment of this printer to your system. Refer to Table 14 for special system requirements.

This printer attaches to the following host devices and workstations:

- IBM System i™ Host Systems (formerly iSeries) — Parallel Port and Twinax Interface
- zSeries Host Systems (formerly VM, MVS™, VSE) — Coax Interface
- 3174 Controller — Asynchronous Emulation Adapter
- IBM Personal Computer Systems-ASCII Serial or Parallel port
- pSeries® (formerly RS/6000®) — ASCII Serial or Parallel port
- Systems that support ASCII attachments through the following interfaces:
EIA-232-E Serial, EIA-422-B Serial, PC Parallel, Dataproducts Parallel, and IEEE 1284 Parallel
- Ethernet and Token Ring LANs via the Network Print Server features
- Ethernet LANs via the 6500 Ethernet feature

Note: When a Coax/Twinax feature is installed, it attaches to host devices and workstations that support Coax/Twinax.

Table 14. Operating System Report

Operating Systems Supported	Special Notes/Requirements
pSeries (AIX)	<ul style="list-style-type: none"> Supported by Version 3.1.5 or later.
System i	<ul style="list-style-type: none"> Supported by OSV5R1 or later
Windows®	<ul style="list-style-type: none"> Supported by Microsoft® Windows NT® 4.0, 2000, and XP.
zSeries (z/OS®, x/VM, VSE/ESA™)	<ul style="list-style-type: none"> Existing non-graphics printing applications for the IBM 4234 (Model 001) and IBM 3287 are supported and can be used with this printer. Supported by 3174 with AEA release A5.4 or later, Release B4.0 or later, and Release C1.1 or later.
Other Operating Systems	<ul style="list-style-type: none"> Supported by other operating systems through attaching this printer to the following interfaces: EIA-232-E Serial, EIA-422-B Serial, PC Parallel, Dataproducts Parallel, and IEEE 1284 Parallel. When attaching this printer to a Digital Equipment Corporation** VAX** machine, the preferred attachment is through EIA-232-E serial interface.

Note: For more specific information, refer to either the *InfoPrint 6500 ASCII Programmer's Reference Manual* or the *InfoPrint 6500 Coax/Twinax Programmer's Reference Manual*.

Compatibility and Limitations

The following are some compatibility and limitation considerations you should be familiar with before attaching this printer with your system.

Compatibility

- The Proprinter III XL emulation is very similar to the datastream used by the IBM 4202-003 Proprinter but contains more features. This protocol enables this line matrix printer to closely emulate a moving-head serial matrix printer but does not support downloaded fonts. In addition, NLQ compresses to 17.1 CPI, not 20 CPI.
- The Epson-LQ emulation does not support downloaded characters or print justification. In addition, near letter quality (NLQ) compresses to 17.1 CPI not 20 CPI.

- For pSeries emulation, differences in supported fonts and control codes may exist between the InfoPrint 6500 and Printronix printers. Downloaded character overlays and downloaded character sets are not supported. Detailed information on supported fonts and control codes can be found in the *InfoPrint 6500 ASCII Programmer's Reference Manual*.
- For pSeries XQ Variant, the InfoPrint 6500 only prints condensed print at 15 CPI like the Printronix P600, but unlike the P300, which printed condensed print at either 13.3 or 16.7 CPI.
- Emulation differences may exist between the InfoPrint 6500 with Epson FX 1050 emulation and the Printronix MVP 150B, which used the Epson MX emulation.
- Application differences may exist between the InfoPrint 6500 and the Printronix MVP-150C printers due to additional print quality modes which the 6500 does not support.
- Printronix printers with an "L" in the model design indicate the printer has the capability to print smaller dots. The InfoPrint 6500 will print text-only applications that were printed by L-Series printers. Applications requiring the printing of anything other than text will not be supported.
- DAVFU, DVFU, NVFU, and CVFU Vertical Format Units, along with the optional uses of the Serial Data Bit 8, are not supported.
- Printronix P6XX0 models using older C1 controllers, which are primarily installed in Europe, are not supported.
- The following printers, which are similar to Printronix printers, are not supported by the InfoPrint 6500 printer: KPG Panda, TRILAx (Trilog Inc.), and Gentry REVerse Paper Feed.
- The InfoPrint 6500 does not support compatibility with the Printronix P1013 or the P4160.
- InfoPrint printers with the following interfaces are not supported: S/370™ Channel Attachment, QMS** 2780 or 3780 Bisync-to-ASCII attachment, RS-232 as Current® Loop, and Dataproducts Long Lines.

Limitations

- Forms length maximum of 24 inches. In the cabinet models, forms longer than 12 inches can be accommodated by opening the front and rear doors.
- Maximum forms width of 17 inches (including tear strips) or 16 inches (without tear strips).
- Use 15 to 100 pound (6.8 to 45.36 kg) stock with a maximum thickness of 0.025 inches (0.0635 cm).
- Maximum print line of 13.6 inches.
- Friction feed paper handling is not supported.
- Use of high speed (Draft mode) fonts using greater than 15 CPI for critical applications should be tested, prior to production use, using your application to determine if the output is satisfactory.
- Processing of forms with black or dark colored backing, or forms with see-through plastic or cellophane covered openings or windows may give false End-of-Forms (EOF) signals. Request For Price Quote (RPQ) S02392 (factory-installed) or S02394 (field-installed) may be ordered to provide a modified EOF switch to handle these types of forms. Contact your InfoPrint Solutions Company Sales Representative or InfoPrint Solutions Company Authorized Remarketer.
- Downloaded characters are not supported in Proprinter, Epson, pSeries, pSeries XQ Variant, or Serial Matrix emulations.
- Due to the variation in carbonless forms, you should test forms with four or more parts for readability prior to production use. Carbonless forms can be affected by storage and other environmental conditions and should be tested periodically from your application to make sure the output meets your requirements.
- Compatibility differences may exist when replacing or coexisting with older printers, due to technology differences, product and application customization, and emulations.
- The Coaxial portion of the Coax/Twinax feature of this printer is subject to the following limitations:
 - Minimum dot matrix of 9 wide by 8 high
 - Minimum dot matrix of 4 or 7 wide by 8 high

Note: The following features are not supported:

IBM 3287 Models 1C and 2C

Programmed symbols 2 and 4, 190 character downloadable fonts

Data analysis = APL feature

Graphic escape

- The Twinaxial portion of the Coax/Twinax feature of this printer is subject to the following limitations:
 - Minimum dot matrix of 9 wide by 8 high
 - Minimum dot matrix of 4 or 7 wide by 8 high
 - Print lines greater than 198 characters
- TN5250 as opposed to Twinax (Non-IPDS) on the InfoPrint 6500:
 - There are a few features that may have been available through Twinax (Non-IPDS) that are not supported under TN5250. Some of the unsupported features are superscript, subscript, and word underscore. Some of the limitations are line density, character selection, and page presentation. This is a partial listing, so it is suggested that you review your jobs to determine which adjustments should be made to accommodate these limitations.
- InfoPrint 6500 as opposed to 4234 IPDS Comparisons - 4234 Emulation Differences
 - The 4234 emulation will not support Load Symbol Sets (LSS)
 - The 4234 emulation will use Courier for all Near Letter Quality (NLQ) mode printing, whereas 4234-NLQ mode was Gothic for 13.3, 16.7, and 18 CPI. The dot sizes are different.
 - Also, the 6500 has a single dot size vs. three with 4234. For bar code applications, some combinations of unit module width, wide-to-narrow ratio, and element height may affect read rates.
 - The 4234 emulation will support image and font resolution of 120 x 144 pel, compared to 144 x 144 pel in the 4234. This will cause images to change size vertically.
- Proportional Space Mode (PSM) is not the same in your new printer. Some differences will occur.
- InfoPrint 6500 as opposed to 4234 IPDS Comparisons - Differences:
 - The 6500 will report Loaded Font command set (LF2) in the Sense Type and Model (STM), but will not support Load Symbol Set (LSS).
 - The 6500 will support Page Continuation Actions (PCA) without highlighting.
 - The 6500 cannot detect Human Readable Information (HRI) outside of the Bar Code Presentation space under all circumstances.
- For InfoPrint 6500 printers running IPDS, the host and printer can encounter communication problems when the host session is ended while the printer is offline due to being in a **NOT READY** state (for example, the **STOP** key is pressed) or an error condition (for example, a paper jam). Use one of the following procedures:
 - If the session has already ended, follow the steps for using the **CANCEL** key in “Using the Operator Panel” on page 23. This clears out the printer buffers and allows it to resynchronize with the host.
 - If the session needs to be ended, leave the printer online (in **READY** state) and cancel the job from the host or end the host’s session with the printer. Do not take the printer offline (that is, put it in the **NOT READY** state) until the session has ended.

Note: For information on differences between this printer’s data stream emulations and other printer data streams, such as the IBM Proprinter III XL, please refer to the *InfoPrint 6500 ASCII Programmer’s Reference Manual*.

Appendix D. Attaching Host Systems to a Coax/Twinax Printer

Attaching Printer to an IBM System i or zSeries Host System

The following information describes how to attach this printer to a zSeries or IBM System i^{TM1} System.

If you are installing this printer with the IPDS feature, review the *InfoPrint 6500 IPDS Programmer's Reference Manual* for information on attaching a printer to host systems using IPDS.

Attaching Printer to an IBM System i Host System

This chapter provides specific instructions on attaching the printer to your computer.

Supported host workstations include:

- IBM System i
- 5294, 5394, and 5494 Remote Control Units

Attaching Printer to an IBM System i with Twinax Interface



DANGER:

- | |
|--|
| <p><4> Do not connect or disconnect any communication port, teleport, attachment connector, or power cord during an electrical storm.</p> <p><5> Power off the printer and disconnect the power cord before connecting or disconnecting communication port, teleport, or attachment cable connector.</p> |
|--|

1. Formerly known as iSeries.

Follow these steps:

1. Select a printer address from 0 through 6.
2. From the printer operator panel Twinax Interface menu, make sure the printer address matches the printer address you selected from the table above. You can select addresses ranging from 0 through 6; the default address is 1.
3. If the IPDS feature is not installed, you must choose to emulate either a 5225 or 4234-2 printer from the Twinax Interface menu, under Printer Emulation. The default is 4234-2 printer emulation.
4. If the IPDS feature is installed, you must choose to emulate a 4234-12, from the IPDS menu, under IPDS Emulation Mode. The default is 4234-12 printer emulation. See the *IPDS Programmer's Reference Manual* for information on the IPDS Emulation Mode values.
5. Turn printer off.
6. Attach the Twinax cable from your printer to your host workstation.
7. Turn the printer back on. The IBM System i's auto configuration program will query the printer and configure the host system software to recognize the printer.
8. You may want to execute the IBM System i Workstation Printer (VFYPRT) Verification Test to make sure the IBM System i host system recognizes the printer.

Note: If you do not want to use the system printer configuration that is created by the auto configuration program, you can change the printer configuration values as described in the following section.

Changing Your IBM System i Printer Configuration

For more information on configuring a printer, see *iSeries Device Configuration Guide* or the online configuration information on the system.

Changing Configuration with Auto Configuration

Auto Configuration can be utilized when either locally or remotely attaching to the system. The printer is configured as DEVTYPE (4234). Other parameters are automatically assigned by the system. See the *iSeries Device Configuration Guide* for more information.

Changing Printer Configuration Settings on IBM System i

If you want to change the settings created by IBM System i auto configuration, you will need to use the following parameters:

Parameter Description	Parameter	Parameter Setting
Device description	DEVVD	Workstation printer name
Device class	DEVCLS	*LCL
Device type	TYPE	*IPDS (When printer is set to 4234-12 mode.)
Device type	TYPE	4234 (When printer is set to 4234-2 mode.)
Device model	MODEL	0000 (00 if IPDS (4234-12) and 02 if SCS (4234-2)) Type can be set to 6408 or 6412. CTA for 6408 or 6412 model.
Advance Function	AFP™	*NO (See Note)
Port number Printing	PORT	x
Switch setting	SWTSET	y (Printer station address)
Online at IPL	ONLINE	*YES
Attached controller	CTL	Twinaxial workstation controller name
Font identifier	FONT	zzz (Default font identifier)
Form feed	FORMFEED	* Cont

Note: AFP *Yes can be specified if the level of IBM System i OS supports the printer as an AFP printer and PSF is installed.

Attaching Printer to Remote Control Unit with Twinax Interface

IBM System i auto configuration program does not support remote attached printers. You must manually configure this printer as a remote printer attached to a 5294, 5394, or 5494 Remote Control Unit. Use the following parameters when configuring this printer as a remote printer on IBM System i:

Parameter Description	Parameter	Parameter Setting
Device description	DEVVD	Workstation printer name
Device class	DEVCLS	*RMT
Device type	TYPE	*IPDS (When printer is set to 4234-12 mode.)
Device type	TYPE	4234 (When printer is set to 4234-2 mode.)
Device model	MODEL	0000 (00 if IPDS (4234-12) and 02 if SCS (4234-2)) Type can be set to 6408 or 6412. CTA for 6408 or 6412 model.
Advanced Function	AFP	*NO (See Note)
Location Address	LOCADR	xx
Online at IPL	ONLINE	*YES
Attached controller	CTL	Remote controller name
Font identifier	FONT	yyy (Default font identifier)
Form feed	FORMFEED	* Cont

Note: AFP *Yes can be specified if the level of iSeries supports the printer as an AFP printer and PSF is installed.

Attaching Printer to zSeries Systems

It is necessary to define a printer in the zSeries environment to VTAM*, JES2, POWER, PSF, VPS, JES328X Print Facility, NCP, VM, VSE, MVS, and/or other software depending upon your operating environment and printing requirements.

If you are attaching a printer with the IPDS feature installed, review the *InfoPrint 6500 IPDS Programmer's Reference Manual* for information on configuring IPDS.

Types of Installation covered for MVS/JES2

Below is a list of configurations covered in this section:

- LU1-SCS-Local SNA 3174 Control Unit
- LU1-SCS-Remote SNA 3174 Control Unit
- LU3-DSE-Local SNA 3174 Control Unit
- LU3-DSE Remote SNA 3174 Control Unit
- LU0-DSC-Local Non-SNA 3174 Control Unit

6500-LU1-SCS-Local SNA 3174 Control Unit

LU1-SCS mode is utilized when *neither PSF support nor IPDS is required* to accomplish the print function desired. An existing local 3174 SNA-connected control unit is assumed. The steps required to install a local LU1-SCS printer for host definitions are as follows:

1. Define to VTAM® by adding logmode entry to VTAM Logmode Table
2. Define to JES2 (Not required but recommended. See the following details.
3. Define to CICS®* or another Application Program such as VPS or JES328X products.
4. Select the options on the printer that are appropriate for the environment.

Step 1 - VTAM Definition

The following should be added to the Local Major Node VTAM definition. The printer will be attached as an LU1-IPDS capable printer.

```
LOC3174V    BUILD TYPE=LOCAL
LOCPU74    PU      CUADDR=nnn...
LOC6500    LU
LOCADDR=n,MODETAB=MYMODETB,DLOGMODE=6500SCSL,ISTATUS=ACTIVE
```

The following entry should be placed in the VTAM MODE TABLE specified above or another of your choice.

```
6500SCSL MODEENT LOGMODE=6500SCSL,  
  
    FMPROF=X'03',TSPROF=X'03',PRIPROT=X'B1',  
    ECPROT=X'90',COMPROT=X'3080',RUSIZES=X'8787',  
    PSERVIC=X'01000000E100000000000000',  
    PSNDPAC=X'02',SRCVPAC=X'02',SSNDPAC=X'00'
```

Step 2 - JES2 Definition (SYS1.PARMLIB)

```
RMT1 LUTYPE1,BUFSIZE=3840,LINE=1,NUMRD=0,NUMPR=1,NOCOMP,NOCMPCT,  
    SETUPHDR,CONSOLE  
R1.PR1 CLASS=A,NOSEP,PRWIDTH=132,NOFCBLOD,WS=(W,R,Q,PMD,LIM,F,T/C,P),  
    CKTPAGE=30  
DESTID NAME=LOC6500,DEST=R1
```

Step 3 - Define to CICS or another application program

An application program must provide the SCS commands to control the printer. CICS, VPS, and other applications support SCS as well as numerous application programs, both customer written and vendor supplied. Refer to the vendor documentation for defining an SCS printer to the program for its use. If there is no specific information on the InfoPrint 6500 you may use the IBM 4234 for reference.

Step 4 - Printer Settings

It is recommended that the following printer settings be changed from factory default settings:

- Printer Control => Interface Selection => Coax
- Coax Interface => Format Control => Enable

6500-LU1-SCS-Remote SNA 3174 Control Unit

LU1-SCS mode is utilized when *neither IPDS nor PSF* is needed to accomplish the print function desired. An existing remote 3174 SNA-connected control unit is assumed. The steps required to install a remote LU1-SCS printer for host definitions are as follows:

1. Define to NCP, point to LU1 logmode entry defined below
2. Define to VTAM by adding logmode entry to VTAM Logmode Table
3. Define to JES2 (May not required if VPS. See details below)
4. Define to JES328X Print Facility, VPS, or equivalent product.
5. Select the options on the printer that are appropriate for the environment.

Step 1 - NCP Definition

```
XYZ      GROUP      TYPE=NCP,...

LINK     ADRESS=(032),...

REMPU74  PU          ADDR=C1,...

REM6500  LU          LOCADDR=#,(# replaced by port on control unit)

          DLOGMOD=6500SCSR,(Default LOGMODE ENTRY NAME)

          MODETAB=MYTABLE (Table name containing MODEENT)*
```

Step 2 - VTAM Definition

* The following entry should be placed in the VTAM MODE TABLE specified above or another of your choice.

```
6500SCSR MODEENT LOGMODE=6500SCSR,

          FMPROF=X'03',TSPROF=X'03',PRIPROT=X'B1',

          SECPROT=X'90',COMPROT=X'3080',RUSIZES=X'87C6',

          PSERVIC=X'01000000E100000000000000',

          PSNDPAC=X'01',SRCVPAC=X'01'
```

Step 3 - JES2 Definition

This definition is not required if you are using VPS and using U1 - U9999 as the printer ID.

```
RMT1 LUTYPE1,BUFSIZE=3840,LINE=1,NUMRD=0,NUMPR=1,NOCOMP,NOCMPCT,  
      SETUPHDR,CONSOLE (SETUPHDR=PDIR JES2 V3)  
  
R1.PR1 CLASS=A,NOSEP,PRWIDTH=132,NOFCBLOD,WS=(W,R,Q,PMD,LIM,F,T/C,P),  
      CKPTPAGE=30  
  
DESTID NAME=P6500,DEST=R1
```

Step 4 - Define to CICS or another application program

An application program must provide the SCS commands to control the printer. CICS, VPS, and other applications support SCS as well as numerous application programs, both customer written and vendor supplied. Refer to the vendor documentation for defining an SCS printer to the program for its use. If there is no specific information on the InfoPrint 6500 you may use the IBM 4234 for reference.

Step 5 - Printer Settings

It is recommended that the following printer settings be changed from factory default settings:

- Printer Control => Interface Selection => Coax
- Coax Interface => Format Control => Enable

6500-LU3-DSE-Local SNA 3174 Control Unit

LU3-DSE mode is utilized when no host printing controls are required to accomplish the print function desired. The printer settings will be used and cannot be overridden by the host system. An existing local 3174 SNA-connected control unit is assumed. The steps required to install an LU1-DSE printer for host definitions are as follows:

1. Define to VTAM by adding logmode entry to VTAM Logmode Table
2. Define to JES2 (Not required but recommended. See details below)
3. Define to CICS or another Application Program such as VPS or JES328X products.
4. Select the options on the printer that are appropriate for the environment.

Step 1 - VTAM Definition

The following should be added to the Local Major Node VTAM definition. The printer will be attached as an LU1-IPDS capable printer.

```
LOC3174  VBUILD  TYPE=LOCAL

LOCPU74  PU      CUADDR=nnn...

LOC6500  LU

LOCADDR=n,MODETAB=MYMODETB,DLOGMODE=printer,ISTATUS=ACTIVE
```

The following entry should be placed in the VTAM MODE TABLE specified above or another of your choice.

```
6500DSEL  MODEENT  LOGMODE=6500DSEL,

          FMPROF=X'03',TSPROF=X'03',PRIPROT=X'B1',

          SECPROT=X'20',COMPROT=X'3080',RUSIZES=X'C7C7',

          PSERVIC=X'038000000000185018507F00'

          PSNDPAC=X'00',SRCVPAC=X'00',SSNDPAC=X'00'
```

Step 2 - JES2 Definition (SYS1.PARMLIB)

```
RMT1  LUTYPE3,BUFSIZE=3840,LINE=1,NUMRD=0,NUMPR=1,NOCOMP,NOCMPCT,

      SETUPHDR,CONSOLE

R1.PR1  CLASS=A,NOSEP,PRWIDTH=132,NOFCBLOD,WS=(W,R,Q,PMD,LIM,F,T/C,P),

      CKTPAGE=30

DESTID  NAME=LOC6500,DEST=R1
```

Step 3 - Define to CICS or another application program

Refer to the vendor documentation for defining a DSE printer to the program for its use. Host system commands to change printer settings are not supported in DSE mode.

Step 4 - Printer Settings

It is recommended that the following printer settings be changed from factory default settings:

- Printer Control => Interface Selection => Coax
- Coax Interface => Format Control => Enable
- Coax Interface => Early Print Complete => Enable

In LU3 mode the printer settings control the orientation, CPI, LPI and all other aspects of the printed output. Therefore, you must set the printer settings to match the characteristics of the job you are printing. Host controls are not supported in this mode.

6500-LU3-DSE-Remote SNA 3174 Control Unit

- LU1-DSE mode is utilized when host controls are not needed to accomplish the print function desired. An existing remote 3174 SNA-connected control unit is assumed. The steps required to install an LU1-DSE printer for host definitions are as follows:
- Define to (NCP point to LU1 default logmode entry defined below)
- Define to VTAM by adding logmode entry to VTAM Logmode Table
- Define to JES2 (May not required if VPS. See details below)
- Define to JES328X Print Facility, VPS, or equivalent product.
- Select the options on the printer that are appropriate for the environment.

Step 1 - NCP Definition

```
XYZ    GROUP    TYPE=NCP,...

        LINK    ADRESS=(032),...

        PU      ADDR=C1,...

&1uname LU    LOCADDR=#, (# replaced by port on control unit)

                DLOGMOD=6500DSEL,(Default LOGMODE ENTRY NAME)

                MODETAB=MYTABLE (Table name containing MODEENT)*
```

Step 2 - VTAM Definition

* The following entry should be placed in the VTAM MODE TABLE specified above or another of your choice.

```
6500DSER MODEENT LOGMODE=6500DSER

      FMPROF=X'03',TSPROF=X'03',PRIPROT=X'B1',
      SECPROT=X'90',COMPROT=X'3080',RUSIZES=X'87C6',
      PSERVIC=X'038000000000185018507F00'.
      PSNDPAC=X'01',SRCVPAC=X'01'
```

Step 3 - JES2 Definition

This definition is not required if you are using VPS and using U1 - U9999 as the printer ID.

```
RMT1 LUTYPE3,BUFSIZE=3840,LINE=1,NUMRD=0,NUMPR=1,NOCOMP,NOCMPC ,
      SETUPHDR,CONSOLE (SETUPHDR=PDIR JES2 V3)

R1.PR1 CLASS=A,NOSEP,PRWIDTH=132,NOFCBLOD,WS=(W,R,Q,PMD,LIM,F,T/C,P),
      CKPTPAGE=30

DESTID NAME=P6500,DEST=R1
```

Step 4 - Define to CICS or another application program

Refer to the vendor documentation for defining a DSE printer to the program for its use. Host system commands to change printer settings are not supported in DSE mode.

Step 5 - Printer Settings

It is recommended that the following printer settings be changed from factory default settings:

- Printer Control => Interface Selection => Coax
- Coax Interface => Format Control => Enable
- Coax Interface => Early Print Complete => Enable

Since the host controls are not supported, the printer settings for CPI, LPI, and others should be set at the printer.

6500-LU0-DSC-Local Non-SNA 3174 Control Unit

LU0-DSC mode is utilized when no host printing controls are required to accomplish the print function desired and the control unit is attached by a VTAM-Controlled NON-SNA Control Unit. An existing local 3174 NON-SNA-connected control unit is assumed. The steps required to install an LU0-DSC printer for host definitions are as follows:

1. Define to VTAM by adding logmode entry to VTAM Logmode Table
2. Define to JES2 (Not required but recommended. See details below)
3. Define to CICS or another Application Program such as VPS or JES328X products.
4. Select the options on the printer that are appropriate for the environment.

Step 1 - VTAM Definition

The following should be added to the Local Major Node VTAM definition. The printer will be attached as an LU1-IPDS capable printer.

```
LOC3174      VBUILD      TYPE=LOCAL
LOCPU74      PU          CUADDR=nnn...
LOC6500      LU
LOCADDR=n,MODETAB=MYMODETB,DLOGMODE=printer,ISTATUS=ACTIVE
```

The following entry should be placed in the VTAM MODE TABLE specified above or another of your choice.

```
6500DSCSCL MODEENT LOGMODE=6500DSCSCL,
          FMPROF=X'02',TSPROF=X'02',PRIPROT=X'60',
          SECPROT=X'40',COMPROT=X'0000',RUSIZES=X'C7C7',
          PSERVIC=X'000000000000185018507F00'
          PSNDPAC=X'80',SRCVPAC=X'00',SSNDPAC=X'00'
```

Step 2 - JES2 Definition (SYS1.PARMLIB)

```
RMT1 LUTYPE0,BUFSIZE=3840,LINE=1,NUMRD=0,NUMPR=1,NOCOMP,NOCMPCT,
      SETUPHDR,CONSOLE
R1.PR1 CLASS=A,NOSEP,PRWIDTH=132,NOFCBLOD,WS=(W,R,Q,PMD,LIM,F,T/C,P),
      CKTPAGE=30
DESTID NAME=LOC6500,DEST=R1
```

Step 3 - Define to CICS or another application program

Host commands for changing printer settings are not supported in this mode. Refer to the vendor documentation for defining an DSC printer to the program for its use.

Step 4 - Printer Settings

It is recommended that the following printer settings be changed from factory default setting:

- Printer Control => Interface Selection => Coax
- Coax Interface => Format Control => Enable
- Coax Interface => Early Print Complete => Enable

In LU0 mode the printer settings control the orientation, CPI, LPI and all other aspects of the printed output. Therefore, you must set the printer settings to match the characteristics of the job you are printing. Host controls are not supported in this mode.

Attaching Printer to VM Host System

Below are sample execs you can read in order to help you to understand how to attach this printer to a VM host system:

SNA Attachment

Sample exec file for attaching with SNA protocols:

```
/* Signal JUST_VM */
'CP SMSG VTAMOPX F NET,DEFAULTS,ID=LS6C004,DLOGMOD=LU1PRT'
/* 'CP SMSG VTAMOPX F NET,DEFAULTS,ID=LS6C004,DLOGMOD=LU3PRT' */
pull upper pause
'SMSG RSCSCOAX STOP SNA6C004'
'SMSG RSCSCOAX DELET SNA6C004'
'SMSG RSCSCOAX DEFINE SNA6C004 LUNAME LS6C004 TYPE SNA3270P'
/* 'SMSG RSCSCOAX DEFINE SNA6C004 PARM VFC=YES SEP=YES TR=ASISCC' */
'SMSG RSCSCOAX DEFINE SNA6C004 PARM VFC=YES SEP=NO TR=ASISCC'
/* 'SMSG RSCSCOAX DEFINE SNA6C004 PARM VFC=YES SEP=NO' */
'SMSG RSCSCOAX START SNA6C004 CLASS * QUEUE FIFO FORM *'
JUST_VM:
'CP SPOOL PRINT TO RSCSCOAX'
'CP TAG DEV PRT TO SNA6C004 SYSTEM 1'
'CP TA DE PRT SNA6C004 SYSTEM 1'
```

Non-SNA Attachment

Sample exec file for attaching to a LOCAL 3174 NON SNA port

```
/* Signal JUST_VM to avoid redefining printer */
'DISABLE XXXX'
'ATT 1601 TO RSCSCOAX AS XXXX'
'SMSG RSCSCOAX STOP PRTXXXX'
'SMSG RSCSCOAX DELET PRTXXXX'
'SMSG RSCSCOAX DEFINE PRTXXXX LINE XXXX TYPE 3270P PARM BUF=2560'
Use as appropriate:
/* 'SMSG RSCSCOAX DEFINE PRTXXXX LINE 1601 TYPE 3270P PARM COMP=NO' */
/* 'SMSG RSCSCOAX DEFINE PRTXXXX PARM VFC=YES SEP=YES' */
/* 'SMSG RSCSCOAX DEFINE PRTXXXX PARM VFC=YES SEP=NO' */
/* 'SMSG RSCSCOAX DEFINE PRTXXXX PARM VFC=NO SEP=NO TR=ASISCC' */
/* 'SMSG RSCSCOAX DEFINE PRTXXXX PARM VFC=NO SEP=NO TR=TEXT FEAT=AT' */
/* 'SMSG RSCSCOAX DEFINE PRTXXXX PARM VFC=NO SEP=NO ' */
'SMSG RSCSCOAX DEFINE PRTXXXX PARM VFC=NO SEP=NO'
'SMSG RSCSCOAX START PRTXXXX CLASS * QUEUE FIFO FORM *'
JUST_VM:
'CP SPOOL PRINT TO RSCSCOAX'
'CP TAG DEV PRT TO PRTXXXX SYSTEM 1'
'CP TA DE PRT PRTXXXX SYSTEM 1'
```

Physical and Logical Unit Types

This section describes some of the Physical Unit (PU) types and Logical Unit (LU) types that you are likely to use when configuring this printer on your host system. Generally, the PU defines the type of communications relationship that the HOST VTAM has with a communications controller such as a 3174 control unit or a controller inside a printer such as a 3820 or 3935. Alternatively, it can describe the relationship that one host VTAM has to another host VTAM or equivalent, such as a System i.

Physical Unit (PU) types and examples

Physical Units, as implied, are part of the physical hardware such as a control unit (3174). VTAM and NCP use various PU types in conjunction with the Logical Unit (LU) types to define the device and logical session to be established with an SNA network.

PU type 2

The PU type 2 is the physical unit type that is required for an LU type 0, type 1, or type 3 (see LU type description following). Examples of PU type 2 are 3174 control units.

PU type 2.1

The PU type 2.1 is the physical unit type that is required for an LU 6.2 (see LU type description following). Examples of PU type 2.1 is an IBM 3820, IBM 3935, or PSF/2.

Summary of LU Types and Representative IBM Products

Listed below are the LU types that SNA currently defines and the kind of configuration or application that each type represents. Also mentioned are hardware or software products that typically use each type of logical unit. A logical unit (LU) describes the type of relationship that the Host VTAM and applications have with a specific device such as a printer. This relationship determines the commands supported from the host to the device and the type of feedback the device gives to the host.

LU type 0

LU type 0 printers are Non-SNA Local or Bisync connections. This mode is also commonly called DSC (Data Stream Compatibility) mode printing. An example of an LU 0 printer connection is an IBM 3816 attached to a non-SNA 3174 control unit. Not all printers support this type connection. This connection type is used when VTAM is controlling the non-SNA control unit and device.

LU type 1

An LU type 1 is for an application program that communicates with single or multiple-device data processing workstations in an interactive, batch data transfer, or distributed data processing environment. The data stream conforms to the SNA Character String (SCS) or Document Content Architecture (DCA). Examples of printers that are able to communicate via LU1 are 4230, 4234, 3930, InfoPrint 6500 and others.

LU type 1 is the basic logical unit type for SCS, IPDS, and AFPDS (PSF) printing. The type of connection is determined by the application that will be driving the printer. The selection is made by changes in the VTAM logmode entry that is used for the logical unit. See the examples for the type of connection desired.

LU type 2

LU type 2 is use by an application program that communicates with a single display workstation in an interactive environment, using the SNA 3270 data stream. Type 2 LU's also use the SNA 3270 data stream for file transfer. An example of an LU type 2 device is a 3270 display such as a 3278, 3178, and others.

LU type 3

An LU type 3 is for an application program that communicates with a single printer using the SNA 3270 data stream. Another name for this connection is Data Stream Extended (DSE). This type of connection will not support the SCS data stream and may be used when no host controls are to be sent to the printer. An example of printers that may use this method of connection are 4230, 3912, 6500, 3930, and others.

LU type 4

LU type 4 is seldom used today. It is used for (1) an application program that communicates with a single or multiple-device data processing or work processing workstation in an interactive, batch data transfer, or distributed data processing environment (for example, an LU for an application program that uses CICS/VS and communicates with an IBM 6670 Information Distributor); or (2) logical units in peripheral nodes (for example, two 6670s) that communicate with each other. The data stream is the SNA Character String (SCS) for data processing environments and Office Information Interchange (OII) Level 2 (a precursor of DCA) for word processing environments.

LU type 6.1

An LU type 6.1 is for an application subsystem that communicates with another application subsystem in a distributed data processing environment. An example of an LU type 6.1 is an application program that uses CICS/VS and communicates with an application program that uses IMS/VS.

LU type 6.2

An LU type 6.2 supports sessions between two applications in a distributed data processing environment. The data stream is either the SNA General Data Stream (GDS), which is a structure-field data stream, or a user-defined data stream. LU 6.2 sessions provide communication between (1) two PU type 5 nodes (host resource-owning VTAM), (2) a PU type 5 node and a PU type 2.1 node, and (3) two PU type 2.1 nodes. Examples (1) VTAM-to-VTAM communication, or an application program that uses CICS/VS and communicates with another application program that uses CICS/VS, (2) An application program which uses VTAM and PSF/MVS communicating with an IBM 3820, 3935, or PSF/2; or (3) Two System i systems communicating in APPC mode.

LU type 7

An LU type 7 is for an application program and a single display workstation in an interactive environment. An example of an LU type 7 is an application program in an System i communicating with a 5250-type terminal. The data stream is the 5250 data stream.

Notices

This information was developed for products and services offered in the U.S.A.

InfoPrint Solutions Company may not offer the products, services, or features discussed in this document in other countries. Consult your local InfoPrint Solutions Company representative for information on the products and services currently available in your area. Any reference to an InfoPrint Solutions Company product, program, or service is not intended to state or imply that *only* that InfoPrint Solutions Company product, program, or service may be used. Any functionally equivalent product, program, or service that does not infringe any InfoPrint Solutions Company intellectual property rights may be used instead. However, it is the user's responsibility to evaluate and verify the operation of any non-InfoPrint Solutions Company product, program, or service.

InfoPrint Solutions Company may have patents or pending patent applications covering subject matter described in this document. The furnishing of this document does not give you any license to these patents. You can send license inquiries, in writing, to:

InfoPrint Solutions Company, LLC
6300 Diagonal Hwy 002J
Boulder, CO 80301-9270
U.S.A.

The following paragraph does not apply to the United Kingdom or any other country where such provisions are inconsistent with local law: INFOPRINT SOLUTIONS COMPANY PROVIDES THIS PUBLICATION "AS IS" WITHOUT WARRANTY OF ANY KIND, EITHER EXPRESS OR IMPLIED, INCLUDING, BUT NOT LIMITED TO, THE IMPLIED WARRANTIES OF NON-INFRINGEMENT, MERCHANTABILITY OR FITNESS FOR A PARTICULAR PURPOSE. Some states do not allow disclaimer of express or implied warranties in certain transactions, therefore, this statement may not apply to you.

This information could include technical inaccuracies or typographical errors. Changes are periodically made to the information herein; these changes will be incorporated in new editions of the publication. InfoPrint Solutions Company may make improvements and/or changes in the product(s) described in this publication at any time without notice.

Any references in this information to non-InfoPrint Solutions Company Web sites are provided for convenience only and do not in any manner serve as an endorsement of those Web sites. The materials at those Web sites are not part of the materials for this InfoPrint Solutions Company product and use of those Web sites is at your own risk.

InfoPrint Solutions Company may use or distribute any of the information you supply in any way it believes appropriate without incurring any obligation to you.

Any performance data contained herein was determined in a controlled environment. Therefore, the results obtained in other operating environments may vary significantly. Some measurements may have been made on development-level systems and there is no guarantee that these measurements will be the same on generally available systems. Furthermore, some measurement may have been

estimated through extrapolation. Actual results may vary. Users of this document should verify the applicable data for their specific environment.

Information concerning non-InfoPrint Solutions Company products was obtained from the suppliers of those products, their published announcements or other publicly available sources. InfoPrint Solutions Company has not tested those products and cannot confirm the accuracy of performance, compatibility or any other claims related to non-InfoPrint Solutions Company products. Questions on the capabilities of non-InfoPrint Solutions Company products should be addressed to the suppliers of those products.

All statements regarding InfoPrint Solutions Company's future direction or intent are subject to change or withdrawal without notice, and represent goals and objectives only.

If you are viewing this information softcopy, the photographs and color illustrations may not appear.

References in this document to InfoPrint Solutions Company products, product features, programs or services do not imply that InfoPrint Solutions Company intends to make such products, product features, programs or services available in all countries in which InfoPrint Solutions Company operates or does business.



This unit must be recycled or discarded according to applicable local and national regulations. InfoPrint Solutions Company encourages owners of information technology (IT) equipment to responsibly recycle their equipment when it is no longer needed. InfoPrint Solutions Company offers a variety of product return programs and services in several countries to assist equipment owners in recycling their IT products. Information on InfoPrint Solutions Company product recycling offerings can be found on InfoPrint Solutions Company's Internet site at:

<http://www.infoprint.com>

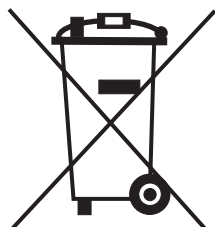

Notice: This mark applies only to countries within the European Union (EU), Norway, and Switzerland.

Appliances are labeled in accordance with European Directive 2002/96/EC concerning waste electrical and electronic equipment (WEEE). The Directive determines the framework for the return and recycling of used appliances as applicable throughout the European Union. This label is applied to various products to indicate that the product is not to be thrown away, but rather reclaimed upon end of life per this Directive.

In accordance with the European WEEE Directive, electrical and electronic equipment (EEE) is to be collected separately and to be reused, recycled, or recovered at end of life. Users of EEE with the WEEE marking per Annex IV of the WEEE Directive, as shown above, must not dispose of end of life EEE as unsorted municipal waste, but use the collection framework available to customers for the return, recycling and recovery of WEEE. Customer participation is important to minimize any potential effects of EEE on the environment and human health due to the potential presence of hazardous substances in EEE. For proper collection and treatment, contact your local InfoPrint Solutions Company representative.

Product recycling and disposal

This unit may have lead-containing materials – such as circuit boards and connectors – that require special handling. Before this unit is disposed of, these materials must be removed and recycled or discarded according to applicable regulations. This book contains specific information on batteries and refrigerant where applicable.

This product may contain a sealed, lead-acid battery; lithium battery; nickel-metal-hydride battery; or nickel-cadmium battery. Batteries of these types must be recycled or disposed of properly. Recycling facilities may not be available in your area.

In the United States, InfoPrint Solutions Company has established a collection process for reuse, recycling, or proper disposal of used batteries and battery packs from InfoPrint Solutions Company equipment. For information on proper disposal of the batteries in this product, please contact InfoPrint Solutions Company.

For information on disposal of batteries outside the United States, contact your local waste disposal facility.

Trademarks

These terms are trademarks or registered trademarks of Ricoh® Co., Ltd., in the United States, other countries, or both:

- InfoPrint
- Infoprint
- Ricoh
- IPDS
- Intelligent Printer Data Stream
- AFP

These terms are trademarks or registered trademarks of International Business Machines Corporation in the United States, other countries, or both:

- AIX
- AIX 5L™
- IBM
- 400
- AT
- CICS
- CT
- DPI
- iSeries
- MVS
- PAL
- Print Services Facility
- pSeries
- RISC System/6000
- RS/6000
- S/370
- SAA
- System i
- System i5
- Systems Application Architecture
- VSE/ESA
- VTAM
- z/OS
- zSeries

Adobe®, the Adobe logo, PostScript®, and the PostScript logo are either registered trademarks or trademarks of Adobe Systems Incorporated in the United States and/or other countries.

Intel®, Intel Inside® (logos), MMX, and Pentium® are trademarks of Intel Corporation in the United States, other countries, or both.

Java™ and all Java-based trademarks are trademarks of Sun Microsystems, Inc. in the United States, other countries, or both.

Linux® is a registered trademark of Linus Torvalds in the United States, other countries, or both.

Microsoft, Windows, Windows NT, and the Windows logo are trademarks of Microsoft Corporation in the United States, other countries, or both.

UNIX® is a registered trademark of The Open Group in the United States and other countries.

Other company, product, or service names may be trademarks or service marks of others.

Communication statements

Federal Communications Commission (FCC) Statement

This equipment has been tested and found to comply with the limits for a Class A digital device, pursuant to Part 15 of the FCC Rules. These limits are designed to provide reasonable protection against harmful interference when the equipment is operated in a commercial environment. This equipment generates, uses, and can radiate radio frequency energy and, if not installed and used in accordance with the instruction manual, may cause harmful interference to radio communications. Operation of this equipment in a residential area is likely to cause harmful interference in which case the user will be required to correct the interference at his own expense.

Properly shielded and grounded cables and connectors must be used in order to meet FCC emission limits. InfoPrint Solutions Company is not responsible for any radio or television interference caused by using other than recommended cables and connectors or by unauthorized changes or modifications to this equipment. Unauthorized changes or modifications could void the user's authority to operate the equipment.

This device complies with Part 15 of the FCC Rules. Operation is subject to the following two conditions: (1) this device may not cause harmful interference, and (2) this device must accept any interference received, including interference that may cause undesired operation.

European Union (EU) Conformity Statement:



Hereby, InfoPrint Solutions Company declares that this product is in compliance with the essential requirements and other relevant provisions of Directive 1999/5/EC.

InfoPrint Solutions Company cannot accept responsibility for any failure to satisfy the protection requirements resulting from a non-recommended modification of the product, including the fitting of non-InfoPrint Solutions Company option cards.

This product has been tested and found to comply with the limits for Class A Information Technology Equipment according to European standard EN 55022. The limits for Class A equipment were derived for commercial and industrial environments to provide reasonable protection against interference with licensed communication devices.

Important

This is a Class A product. In a domestic environment this product may cause radio interference in which case the user may be required to take adequate measures.

Properly shielded and grounded cables and connectors must be used in order to reduce the potential for causing interference to radio and TV communications and to other electrical or electronic equipment. InfoPrint Solutions Company cannot accept responsibility for any interference caused by using other than recommended cables and connectors.

Industry Canada Compliance Statement

This Class A digital apparatus complies with Canadian ICES-003.

Cet appareil numérique de la classe A est conform à la norme NMB-003 du Canada.

Statement for CISPR 22 Edition 2 Compliance: Attention: This is a Class A product. In a domestic environment this product may cause radio interference in which case the user may be required to take adequate measures.

Japanese VCCI Class A:

この装置は、情報処理装置等電波障害自主規制協議会（VCCI）の基準に基づくクラスA情報技術装置です。この装置を家庭環境で使用すると電波妨害を引き起こすことがあります。この場合には使用者が適切な対策を講ずるよう要求されることがあります。

JEITA Statement:

・定格入力電力表示

（社）電子情報技術産業協会 家電・汎用品高調波抑制対策ガイドライン
実行計画書に基づく定格入力電力値： W

または

高調波ガイドライン適合品

または

高調波ガイドライン準用品

German Conformity Statement

Handbuchtex te: FCC class A entspricht : EMVG Klasse A

Text für alle in Deutschland vertriebenen EN 55022 Klasse A Geräte:

Zulassungsbescheinigung laut dem Deutschen Gesetz über die elektromagnetische Verträglichkeit von Geräten (EMVG) vom 18. September 1998 (bzw. der EMC EG Richtlinie 89/336):

Dieses Gerät ist berechtigt in Übereinstimmung mit dem Deutschen EMVG das EG-Konformitätszeichen - CE - zu führen. Verantwortlich für die Konformitätserklärung nach Paragraph 5 des EMVG ist die: InfoPrint Solutions

Company Deutschland GmbH, 70548 Stuttgart. Informationen in Hinsicht EMVG Paragraph 4 Abs. (1) 4:

Das Gerät erfüllt die Schutzanforderungen nach EN 55024 und EN 55022 Klasse A.
--

EN 55022 Klasse A Geräte müssen mit folgendem Warnhinweis versehen werden:
"Warnung: dies ist eine Einrichtung der Klasse A. Diese Einrichtung kann im Wohnbereich Funkstörungen verursachen; in diesem Fall kann vom Betreiber verlangt werden, angemessene Maßnahmen durchzuführen und dafür aufzukommen."

Anmerkung:

Um die Einhaltung des EMVG sicherzustellen sind die Geräte, wie in den InfoPrint Solutions Company Handbüchern angegeben, zu installieren und zu betreiben.

China:

Declaration:

This is a Class A product. In a domestic environment this product may cause radio interference in which case the user may need to perform practical actions.

声 明

**此为 A 级产品, 在生活环境中,
该产品可能会造成无线电干扰。
在这种情况下, 可能需要用户对其
干扰采取切实可行的措施。**

Taiwanese:

Important:

This is a Class A product. In a domestic environment this product may cause radio interference in which case the user will be required to take adequate measures.

警告使用者：
這是甲類的資訊產品，在
居住的環境中使用時，可
能會造成射頻干擾，在這
種情況下，使用者會被要
求採取某些適當的對策。

台灣IBM 產品服務聯絡方式：
台灣國際商業機器股份有限公司
台北市松仁路7號3樓
電話：0800-016-888

Korea:

A급 기기(업무용)

이 기기는 업무용으로 전자파적합등록을 받은 기기이오니
판매자 또는 이용자는 이점을 주의하시기 바라며, 만약
구입하였을 때에는 구입한 곳에서 가정용으로 교환하시기
바랍니다.



DANGER

This product is equipped with a 3-wire power cord and plug for the user's safety. Use this power cord in conjunction with a properly grounded electrical outlet to avoid electrical shock.

Glossary

References

The following cross-references are used in this glossary:

Contrast with. This refers to a term that has an opposed or substantively different meaning.

See. This refers the reader to multiple-word terms that have the same last word.

See also. This refers the reader to related terms that have a related, but not synonymous, meaning.

Synonym for. This indicates that the term has the same meaning as a preferred term, which is defined in its proper place in the glossary.

Synonymous with. This is a backward reference from a defined term to all other terms that have the same meaning.

Terms

A

A to D. Analog to Digital

active. The horizontal location on the paper where the next character will print. After printing a character, the printer advances the active column.

active line. The vertical location on the paper where the next character will print. After printing a line, the printer advances the active line.

active position. The position on the paper where the next character will print. The active position is defined by the horizontal position (active column) and the vertical position (active line).

ACK. (Positive) acknowledge. Affirmative or acknowledge.

ASCII. American Standard Code for Information Interchange. A standard character encoding scheme introduced in 1963 and used widely on many computers and printers. It is a 8-bit code with 256 different bit patterns. There is no parity recommendations.

attributes, print. Operations performed on text that alter its appearance but do not change the font. Examples: underlining, superscripting, bold, and so forth.

B

bar code. A printed code consisting of parallel bars of varied width and spacing and designed to be read by a one-dimensional scanning device.

baud. A unit of speed that measures the rate at which information is transferred. Baud rate is the reciprocal of the length in seconds of the shortest pulse used to carry data. For example, a system in which the shortest pulse is 1/1200 second operates at 1200 baud. On RS-232 serial lines, the baud rate equals the data flow rate in bits per second (bps). To communicate properly, a printer must be configured to operate at the same baud rate as its host computer.

bold. A print attribute specifying text of a heavy line thickness. **This sentence is bold.** See also character weight.

buffer. A reserved area in memory where data is written and read during data transfers.

bus. A circuit for the transfer of data or electrical signals between two devices.

C

character cell. The invisible rectangular space occupied by a character, including the white space around the character. The height of a cell remains constant even with changes in the current line spacing, and the width is equal to the current character spacing. Used as a unit of spacing.

character proportion. The ratio of character height to character width. See also compressed and expanded.

character set. A set of codes, each of which represents a printable character, including symbols, punctuation, numbers, diacritical markings, and alphabet characters. Each character is assigned a unique code value.

character weight. The degree of lightness and thickness of printed text. For example: **Bold** refers to a heavy or thick character weight. Medium, normal, or book weight refer to the character weight used in this sentence.

checksum. A stored or transmitted numerical value used to verify data integrity.

Code V. An optional QMS emulation which allows you to create and store forms, generate logos, bar

codes, and expanded characters, create other graphics, and merge graphics with alphanumeric data as a document is printed.

command. An instruction, such as a form feed command, sent from a computer to the printer (sometimes called a control code or non-printable character). As opposed to data, which is information to be printed.

command delimiter. An ASCII character used to begin a command string (same as SFCC). Commonly used command delimiters are ESC (X'1B' hex) and SOH (X'01' hex).

command sequence. Two or more bytes that instruct the printer to perform a special function. The first character in the sequence is a special function control character (SFCC), which alerts the printer that the string is a command sequence. See also escape sequence, SSCC, and SFCC sequence.

compatibility. The ability of one printer to accept and properly process commands meant for a different printer. See also emulation and protocol.

compressed. Refers to a typeface with a font width approximately 60% smaller than normal. Character height is not changed.

configuration. Refers to the operating properties that define how the printer responds to signals and commands received from the host computer at the printer interface. These properties are called configuration parameters and must be set to match the operating characteristics of the host computer system.

controller. An independent logic unit in a data processing system that controls data paths between the central processing unit and one or more units of peripheral equipment.

cpi. Characters per inch. A unit of measurement of monospaced fonts indicating the horizontal density. For example, 10 cpi means 10 characters can be printed in one horizontal inch.

cps. Characters per second. A measurement of the print speed of a serial (character) printer.

CPU. Central Processing Unit.

CR. Carriage Return.

CT0. Abbreviation for Coax/Twinax only. A model available in a previous generation of the IBM Line Matrix Printer.

CTA. Abbreviation for Coax/Twinax/ASCII.

CTS. Clear To Send.

CVFU. Abbreviation for Centronics direct access Vertical Format Unit.

D

DAVFU. Abbreviation for Direct Access Vertical Format Unit. Also known as NVFU. See also NVFU.

DC. Data Controller.

DCD. Data Carrier Detect.

decipoint. One tenth of a point. A unit of length equal to 1/720 inch. See also point.

default. A value, parameter, attribute, or option that is used by a program or system if another is not specified by the user.

descender. The portion of a printed, lowercase character that appears below the base line. For example, "g", "j", "p", and "y" are characters with lowercase descenders.

diagnostic. Pertaining to the detection and isolation of a printer malfunction or mistake.

disable. To deactivate, make "false" (0) or set to OFF.

DP. Abbreviation for data processing print. This is a mid-quality, mid-speed print resolution.

draft. A limited dot font used for rough copy. Low print quality but fast print speed.

DRAM. Dynamic Random Access Memory.

DSR. Data Set Ready.

DTR. Data Terminal Ready.

DVFU. Abbreviation for Dataproducts direct access Vertical Format Unit.

E

EBCDIC. Extended Binary Coded Decimal Interchange Code.

EC. Engine Controller.

ECMA. European Computer Manufacturers Association.

EIA. Electronic Industries Association.

Elite. A name indicating a monospaced font with a pitch of 12 cpi (and usually 10 points in height).

em. A unit of measure in typesetting. The width of a piece of type about as wide as it is tall. (Derived from uppercase M, usually the widest character in a set.)

EM. End of Message (3287 only).

emulation. The ability of a printer to emulate, or function like a different type of printer. See also compatibility and protocol.

en. A unit of measure in typesetting equal to half the width of an em.

enable. To activate, make “true” (1), or set to ON.

escape sequence. A command sequence in which the first byte is always the ASCII ESC character. See also command sequence, SCCC, and SFCC sequence.

ETX. End of Text.

EVFU. Abbreviation for Electronic Vertical Format Unit. Relates to the ability to slew (skip quickly as a specified number of lines).

expanded. Refers to a typeface with a font width larger than normal. Character height is not changed.

F

family (or type). A set of all variations and sizes of a type style.

FF. Form Feed.

FIFO. First In, First Out.

fixed-pitch fonts. Same as font, monospaced.

FM Header. Format Header. Command strings used to switch between SCS and IPDS.

font. The complete set of a given size of type, including characters, symbols, figures, punctuation marks, ligatures, signs, and accents. To fully describe a font, you must specify seven characteristics:

1. typeface (Courier, Helvetica, Swiss, and so forth)
2. spacing (proportional or monospaced)
3. type size (12 point, 14 point, and so forth)
4. scale factor (character height/width ratio)
5. type style (Roman or italic)
6. character weight (bold, normal, and so forth)
7. character proportion (normal, compressed, expanded).

font, monospaced. Also called fixed-pitch font and mono-font. Every character, regardless of horizontal size, occupies the same amount of font pattern space. All monospaced fonts use specific pitch size settings. Monospaced fonts are sometimes used when strict character alignment is desired (tables, charts, spreadsheets, and so forth).

font name. See typeface.

font pattern. A font pattern is the matrix of pixels which represents a character, symbol, or image.

font, proportional. A font in which the width of a character cell varies with the width of the character. For example, “i” takes less space to print than “m”. Using proportional fonts generally increases the readability of printed documents, giving text a typeset appearance.

font weight. The thickness of the lines making up a character. For example, “bold” and “light” are different font weights.

font width. The measurement of the width of a character cell in dots.

G

gateway. A hardware device that translates data between two incompatible networks.

gateway address. The IP address of a gateway.

H

hammer. The hammer spring with a hammer tip mounted onto it.

hammer spring. The flat piece of metal, made of spring steel, which supports and pushes the hammer tip.

hammer tip. The small, round point, located near the end of the hammer spring, which strikes the ribbon and leaves a dot on the paper.

hex codes. Based on a numeral system with a radix of 16.

host (computer). The computer that stores, processes, and sends data to be printed, which communicates directly with the printer. The term “host” specifies the controlling computer, since modern printers are themselves microprocessor-controlled computer systems.

HS. Abbreviation for high speed font. Also referred to as draft.

HT. Horizontal Tab.

Hz. Hertz. Cycles per second, a measure of frequency.

I

IGP. Intelligent Graphics Processor. An optional emulation that converts graphics commands received from the host computer to binary plot data that is usable by the printer.

initialization. A series of processes and self-tests to set power-up default conditions and parameters.

interface. The hardware component used to line two devices by common physical interconnection, signal, and functional characteristics.

invoke. To put into effect or operation.

IP Address. The Internet Protocol Address. A numeric address such as 123.45.61.23 which identifies a printer or server in a LAN or WAN.

IPDS. Intelligent Printer Data Stream.

ipm. Abbreviation for inches per minute. A measure of the speed of a printer printing in graphics print mode (plotting speed).

italic. A slanted type style. This is an italic type style. Both forward and backward slant are available.

L

LAC. Load Alternate Characters.

LF. Line Feed.

landscape. Printed perpendicular to the paper motion.

LCD. Liquid-crystal display. The LCD is located on the operator panel. Its purpose is to communicate information to the operator concerning the operating state of the printer.

LED. Light Emitting Diode. The printer operator panel has LEDs that indicate the state of the printer to the operator.

logical link. The parameters that specify data transfer, control, or communication operations.

lpi. Abbreviation for lines per inch. A measurement indicating the vertical spacing between successive lines of text. For example, 8 lpi means eight lines of text for every vertical inch.

lpm. Abbreviation for lines per minute. A measurement of the print speed of a line printer printing in text print mode.

M

monospaced. See font, monospaced.

MM. Millimeter.

MPL. Maximum Page Length. Also known as forms length. The number of lines that can be printed on a page.

MPP. Maximum Print Position. Also known as line length. See also PMPP.

N

NAK. Negative acknowledge. Not acknowledged.

N/A. Not available or not applicable.

NL. New Line (3287 only).

NLQ. Abbreviation for near letter quality font. This is the highest resolution mode supported on the 6500.

Not Ready Mode. Offline. The printer is not ready to receive and process commands and data.

nS. Nanosecond.

NVFU. Direct Access Vertical Format Unit. See also DAVFU.

NVRAM. Abbreviation for nonvolatile random access memory. The storage is permanent, in the sense that information is not lost when the printer is powered off.

O

OCR. Abbreviation for Optical Character Recognition. A process by which a machine can "read" characters printed in a special standardized font. Data are read by a photoelectric optical scanner and can be recorded on magnetic tape or disk. OCR-A and OCR-B are two widely used OCR fonts.

Ohm. A unit of measurement for electrical resistance.

P

PA. Program Attention. Used in application programs.

parity (check). Parity checking is the addition of non-data bits to data, resulting in the number of bits that are set to a "1" being either always even or always odd. Parity is used to detect data errors.

PC. Personal Computer.

PCBA. Printed Circuit Board Assembly.

pel. The smallest element of a physical medium that can be independently assigned color and intensity. Pels per inch is often used as a measurement of presentation granularity. Synonymous with picture element, pixel.

PI. Abbreviation for Paper Instruction. A physical hardware I/O line used in conjunction with the eight data bit lines. When PI is set high, it indicates that the eight data bits are interpreted as a paper motion command instead of printable data.

pica. A name indicating a monospaced font with a pitch of 10 cpi (and usually 12 points in height). Pica is also used in typography as a unit of measurement equal to 1/6 inch.

pitch. The number of text characters printed per horizontal inch. Specified in characters per inch or cpi.

pixel. Derived from picture (PIX) ELeMent. The smallest displayable picture element on a video monitor or printable unit. In printing, a pixel is a dot.

PMPP. Physical Maximum Print Position. The longest line the printer is capable of printing. This differs from MPP in that the printer may be capable of printing lines 132 characters wide (PMPP), but the print job is only 80 characters wide (MPP). See also MPP.

point. A unit of length in printing and typography, used to specify type sizes, heights of font characters, and so forth. There are 72 points in a vertical inch; thus, one point equals 1/ 72 inch, or approximately 0.0139 inch.

POR. Power On Reset.

port. A channel used for receiving data from or transmitting data to one or more external devices.

portrait. Printed parallel to the paper motion.

print mode. Font.

proportion, character. See character proportion.

proportional. See font, proportional.

protocol. The rules and conventions that govern communication between a printer and a host computer. A protocol includes codes for printing text and graphics and codes instructing the printer to perform special operations. See also compatibility and emulation.

R

RAM. Random Access Memory. Can be read from or written to at any time. RAM is volatile; whatever information is in RAM is lost when power is removed or interrupted.

RD. Receive Data.

read. To retrieve data from memory or from mass storage (hard disk, floppy diskette, and so forth).

Ready mode. Online. The printer is ready to receive and process commands and data.

reset. To turn off, deactivate, disable, or return to a previously determined state.

resolution. A measure expressing the number of component units in a given range used to create an image in print. Expressed as the number of dots per inch (dpi) horizontally and vertically.

ROM. Read Only Memory. Programs, instructions, and routines permanently stored in the printer that

cannot be written to. Information in ROM is not lost when power is turned off. (ROM-resident fonts are fonts permanently stored in a printer and available at any time via software commands to the printer.)

Roman. An NLQ type style in which the characters are upright and the edges of the characters have a serif. This sentence is printed in a Roman type style.

RTS. Request To Send.

S

SA. Set Attribute.

SAA®. Systems Application Architecture®.

sans serif. An NLQ type style in which the characters are upright and blocked. This sentence is printed in a sans serif type style.

SCS. System Network Architecture (SNA) Character String. Usually commands to set printer format, and so forth.

serial communication. The sequential transmission of data, in which each element is transferred in succession.

set. To turn on, activate, invoke, or enable.

SFCC sequence. Special Function Control Character sequence. Two or more bytes that describe a specific printer control function. The first byte is always the SFCC. This also applies to IGP options.

shuttle. The subassembly in a line matrix printer that includes the hammer bank assembly, plus some or all of the drive mechanism.

size, type. See point.

SLD. Set Line Density.

slew. Rapid vertical paper movement.

SNA. Systems Network Architecture.

SOH. Start Of Header.

spacing. See font, proportional and font, monospaced.

SSCC. SuperSet Control Character. See escape sequence and command sequence.

start bits. In serial data transfer, a signal indicating the beginning of a character or data element.

stop bits. In serial data transfer, a signal indicating the end of a character or data element.

string. Two or more bytes of data or code treated as a unit.

style, type. See type style.

subnet mask. A binary value used to divide IP networks into smaller sub-networks or subnets. This mask is used to help determine whether IP packets need to be forwarded to other subnets.

symbol set. See character set.

T

TCB. Task Control Block.

TD. Transmit Data.

TOF. Top Of Form.

TTL. Transistor-Transistor Logic.

type family. See typeface.

type size. See point.

type style. Refers to either the upright or italic character style in a specific font family. Roman is upright, *italic is slanted*.

typeface. A descriptive name or brand name that identifies a particular design of type. Examples are Courier, Helvetica, and Swiss. Also called type family.

typographic font. See font, proportional.

U

UPC. Universal Product Code.

USERSET. Abbreviation for User-defined Set. An IGP command that creates custom character sets (except OCR fonts) from existing characters stored in memory.

V

VFU. Abbreviation for vertical format unit.

W

warm start. An almost complete reset of the printer:

1. Data are cleared from all buffers.
2. All internal system variables are reset to default (host set).
3. Selected power-up configuration is loaded.

weight. See character weight.

write. To store data to memory (RAM) or to mass storage (hard disk, floppy diskette, and so forth).

Index

Numerics

- 001 END OF FORMS 222
- 002 FORMS JAMMED 222
- 003 FORMS EJECTED 222
- 004 VIEW FORMS 222
- 006 HOST SYSTEM REQUESTS
ATTN 222
- 007 FM HEADER ERROR 222
- 008 HOLD PRINT TIMEOUT 222
- 009 INVALID KEYPRESS 222
- 010 PARAMETER ERROR 222
- 011 SCS COMMAND ERROR 222
- 012 STRUCTURED FLD ERROR 222
- 013 ACTIVATE LOST 222
- 014 INVALID ACTIVATE 222
- 015 COMMUNICATION CHECK 223
- 016 INVALID COMMAND 223
- 017 STACKER JAM 223
- 018 STACKER FULL 223
- 019 STACKER FAULT 223
- 021 PRINT BUFFER OVERRUN 223
- 022 UNIT ADDRESS INVALID 223
- 024 SERIAL LINE PARITY ERROR 223
- 025 FRAMING ERROR 223
- 026 HEX DUMP MODE 223
- 027 COMMUNICATIONS CHECK 223
- 028 COMMUNICATIONS CHECK 223
- 029 8344 DIAGNOSTIC TEST
FAILED 224
- 031 END OF FORMS TIMEOUT 224
- 032 FORMS JAMMED TIMEOUT 224
- 034 TRNSPT STALL TIMEOUT 224
- 035 RIBBON OUT OF INK 224
- 037 STACKER JAM TIMEOUT 224
- 038 STACKER FULL TIMEOUT 224
- 039 STACKER FAULT 224
- 041 BUFFER OVERFLOW 224
- 042 NO CUSTOM SET AVAIL 224
- 043 CUSTOM SET ALREADY
EXISTS 225
- 044 EC FIRMWARE/HARDWARE
ERROR 225
- 045 FIRMWARE ERROR* 225
- 046 EC STOPPED AT STATE 225
- 051 HAMMER SHORT* 225
- 052 MECH DRIVER HOT 225
- 053 48 VOLTS FAILED* 225
- 054 HAMMER COIL SHORT* 225
- 055 MECH. DRIVER LINK
FAILURE 225
- 056 HAMMER COIL OPEN 225
- 057 CLOSE PLATEN 225
- 058 SHUTTLE JAM 225
- 059 CANCEL PRINT ACTIVE 225
- 060 PRINTER HOT 225
- 062 EXHAUST FAN CHECK* 226
- 065 HAMMER FAN CHECK* 226
- 069 DATA CLEARED 226
- 080 POWER SUPPLY HOT 226
- 081 POWER VOLT CHECK* 226
- 082 POWER 8.5V CHECK* 226
- 083 INTAKE FAN CHECK* 226
- 084 POWER 48V CHECK* 226
- 085 CONTROL VOLT CHECK 227
- 086 CONTROL 15V CHECK* 227
- 087 PLATEN OPEN TIMEOUT 227
- 088 CONTROL 23.5V CHECK* 227
- 089 RIBBON STALL CHECK
TRANSPORT 227
- 090 SHUTTLE COVER OPEN 227
- 092 TRNSPT DRVR CIRCUIT 227
- 101 UPPER DRIVER SHORT* 227
- 102 LOWER DRIVER SHORT* 227
- 104 ERROR:DP FIFO BUSY 227
- 105 HAMMER <#> CHECK 227
- 11 Inch Pages 192
- 110 STACK OVERFLOW* 227
- 111 STACK UNDERFLOW* 227
- 112 UNDEFINED OPCODE* 228
- 113 INSTRUCTION SET 228
- 114 ILLGL OPR ACCESS 228
- 115 ILLGL INSTRACCESS* 228
- 116 ILLEGAL BUS ACCESS 228
- 117 A TO D OVERUN* 228
- 118 UNDEFINED INTERRUPT 228
- 119 TCB CORRUPTED* 228
- 120 MACHINE CHECK* 228
- 121 PAPER NOT AT SPEED 228
- 122 PAPER NOT SCHEDULED 228
- 123 PAPER BUSY TOO LONG 228
- 124 PAPER FIFO OVERFLOW 228
- 125 PAPER FIFO UNDERFLOW 228
- 126 FEED TABLE CHECK 228
- 127 ILLEGAL STATE 228
- 128 INVALID COMMAND 229
- 129 INVALID PARAMETER 229
- 130 PAP FEED INCOMPLETE 229
- 131 PAPER FEED INTERRUPT 229
- 132 RIBBON INVALID COMMAND 229
- 133 PAPER NOT SCHEDULED* 229
- 134 INVALID COMMAND 229
- 135 INVALID STATE* 229
- 136 INVALID PARAMETER 229
- 137 SHUTL INVALID COMMAND* 229
- 138 SHUTTLE INVALID
PARAMETER 229
- 139 OVER SPEED CHECK* 229
- 140 48 VOLTS FAILED* 229
- 142 PAP FEED DRIVE FAIL* 229
- 143 SHUTL DRIVER FAILED* 230
- 144 SHUTTLE FAN FAILURE* 230
- 146 RIBBON INK OUT INSTALL NEW
INFOPRINT RIBBON 230
- 147 H/B CONTROL MODE 230
- 148 DRIVER CIRCUIT BAD 230
- 149 HMR BANK NOT INSTALLED 230
- 150 ERROR: EC STOPPED AT STATE
XXXX 230
- 159 HAMMERBANK HOT 230
- 160 ERROR: DC PROGRAM NOT
VALID 230
- 161 ERROR: DRAM AT ADDRESS
XXXXXXXX 230
- 162 ERROR: EC PROGRAM NOT
VALID 230
- 163 ERROR: FLASH DID NOT
PROGRAM 230
- 164 ERROR: SDRAM JEDEC
MISSING 230
- 165 ERROR: NO DRAM
DETECTED 231
- 166 ERROR: NVRAM FAILURE 231
- 167 ERROR: PROGRAM NEEDS MORE
DRAM 231
- 168 ERROR: PROGRAM NEEDS MORE
FLASH 231
- 169 ERROR: PROGRAM NOT
COMPATIBLE 231
- 170 ERROR: PROGRAM NOT
VALID 231
- 171 ERROR: SHORT AT ADDRESS
XXXX 231
- 172 ERROR: WRITING TO FLASH 231
- 173 ERROR: WRONG CHECKSUM 231
- 174 ERROR OCCURRED FLUSHING
QUEUES* 231
- 175 ACCESS NULL POINTER* 231
- 180 ETHERNET ADDRESS ADAPTER
NOT INSTALLED 231
- 181 ETHERNET ADAPTER BEING
INITIALIZED 231
- 182 ETHERNET DETECTED 231
- 190 SECURITY ERROR 232
- 191 SECURITY CODE VIOLATION 232
- 192 SECURITY KEY NOT
DETECTED 232
- 194 INCOMPAT. E-NET NIC REPLACE
NIC 232
- 195 INCOMPAT. WLAN NIC REPLACE
NIC 232
- 20 CPI Condensed
Epson Emulation menu 171
Proprinter III XL Emulation
menu 169
- 200 SOFTWARE ERROR* RECYCLE
POWER 232
- 301 RIBBON INK LOW 232
- 302 EXCESSIVE RIBBON WEAR 232
- 303 BARCODE NOT DETECTED 232
- 304 BARCODE DAMAGED 232
- 305 OLD RIBBON DETECTED 232
- 306 UNKNOWN RIBBON 232
- 307 UNKNOWN RIBBON 232
- 308 BARCODE SENSOR ERR 233
- 3270 Interface menu 87
Active Print Language 89
Alternate Set 80 - 9F 90
C/T Hotport 92
Compatibility Options menu 94
Compatibility Option 1:Carriage
Return at MPP+1 94

- 3270 Interface menu *(continued)*
 - Compatibility Options menu *(continued)*
 - Compatibility Option 10:Bottom Margin (SCS data stream only) 97
 - Compatibility Option 2:New Line at MPP+1 95
 - Compatibility Option 3:Position After Form Feed (4234 only) 95
 - Compatibility Option 4:Form Feed at End of Print Buffer 95
 - Compatibility Option 5:Null Suppression 95
 - Compatibility Option 6:Form Feed Command Position 96
 - Compatibility Option 7:Automatic Form Feed at End of Print Buffer 96
 - Compatibility Option 8:Automatic FF After Operator-Initiated Copy 96
 - Compatibility Option 9:CR, EM, and NL (3287 only) 97
 - Early Print Complete 89
 - Format Control 92
 - Hex Transparent Control 89
 - Intervention Required 91
 - Lead-In Characters 90
 - Maximum Printable Width 93
 - Mono/Dual Case 90
 - Override Host 92
 - Port Type 92
 - Print Character Table 89
 - Print Language 89
 - Print Text Direction 91
 - Timeout 93
 - Undefined Char Substitution 91
 - User Defined Codes 90
 - 48V CIRCUIT* 233
 - 5250 Interface menu 80
 - Active Print Language 82
 - Alternate Set 80 - 9F 83
 - C/T Hotport 85
 - Format Control 85
 - Hex Transparent Control 82
 - Lead-In Characters 83
 - Maximum Printable Width 85
 - Override Host 84
 - Port Type 85
 - Print Character Table 82
 - Print Language 82
 - Print Text Direction 84
 - Report Status 86
 - Timeout 86
 - Undefined Char Reporting 83
 - Undefined Char Sub 84
 - User Defined Codes 83
 - 6500-LU0-DSC-Local Non-SNA 3174 control unit 284
 - 6500-LU1-SCS-Local SNA 3174 control unit 277
 - 6500-LU1-SCS-Remote SNA 3174 control unit 279
 - 6500-LU3-DSE-Local SNA 3174 control unit 281
 - 6500-LU3-DSE-Remote SNA 3174 control unit 282
 - 733 DP FIFO BUSY* 233
 - 990 MACHINE CHECK 233
 - 990 NV-RAM CHECK 233
- A**
- A97 GRAPHIC CHECK ERROR 233
 - About User Manual xiii
 - Absorb at ^PN
 - Code V Configuration menu Graphics Option 162
 - Absorb at ^PY
 - Code V Configuration menu Graphics Option 160
 - Acknowledge, PC Parallel Interface Signals 199
 - acoustic noise level 256
 - Active Emulation
 - Emulation Configuration menu 134
 - Active Print Language
 - 3270 Interface menu 89
 - 5250 Interface menu 82
 - Coax Interface menu 69
 - Active print language, Twinax Interface menu 60
 - Active versus saved configurations 20
 - Adapter Address Submenu
 - Network Setup menu 99
 - DHCP 100
 - Gateway Address 99
 - IP Address 99
 - MAC Address 99
 - Subnet Mask 99
 - Adapter Parameters Submenu
 - Network Setup menu 100
 - ASCII Data Port Number 102
 - Buffer Size in Kilobytes 101
 - Ethernet Hotport 103
 - Ethernet Speed 102
 - IPDS Data Port Number 102
 - Job Control 102
 - Keep Alive Timer 102
 - Nest Serv Type 101
 - NetBIOS Protocol 101
 - Novell Frame 101
 - Novell Protocol 101
 - Report Status 103
 - Timeout 103
 - Trickle Time 103
 - Adapter Test Page
 - Operator Print Tests menu 190
 - All E's
 - Operator Print Tests menu 190
 - All E's + FF
 - Operator Print Tests menu 190
 - All E's + FF (Form Feed) test 215
 - All E's test 215
 - All H's
 - Operator Print Tests menu 190
 - All H's test 215
 - Alternate Character Set
 - Proprinter III XL Emulation menu 168
 - Alternate Set 80 - 9F
 - 3270 Interface menu 90
 - Alternate Set 80 - 9F *(continued)*
 - 5250 Interface menu 83
 - Coax Interface menu 72
 - Alternate Set 80-9F
 - pSeries Emulation menu 174
 - Serial Matrix Emulation menu 180
 - ANSI menu
 - CPI/LPI Select 144
 - Font Attributes
 - Bold Print 145
 - Prop. Spacing (Proportional Spacing) 145
 - Slashed Zero 145
 - Typeface 144
 - Page Format
 - Auto LF 147
 - Barcode Darkmode 149
 - BC Check Digit 149
 - Character Set 148
 - Define CR Code 147
 - Define LF Code 148
 - ESC c Sequence 148
 - ETX/ACK (TBD) 150
 - Form Length 146
 - Form Width 146
 - Margins 146
 - Pos. on BC/OvrSz 149
 - Printer Select 148
 - Private Mode 149
 - PUM Default 149
 - Received CR 148
 - Received DEL 149
 - Reset Command 148
 - Truncate PI Slew 149
 - Antenna Diversity
 - Wireless Parameters menu 111
 - Append Rotated
 - Code V Configuration menu Graphics Option 160
 - ASCII Data Port Number
 - Adapter Parameters Submenu Network Setup menu 102
 - Ethernet Parameters Submenu Network Setup menu 106
 - ASCII Printer Emulation
 - Emulation Configuration menu 134
 - attaching printer
 - IBM System i 273
 - IBM System i with Twinax interface 273
 - MVS host system 277
 - remote control unit with Twinax interface 276
 - VM host system 285
 - attachment, host
 - compatibility 268
 - limitations 270
 - Attachment, printer 11
 - Authentication Method
 - Wireless LEAP menu 115
 - Auto LF
 - ANSI menu
 - Page Format 147
 - Epson Emulation menu 170
 - IGP Emulation menu 152
 - Proprinter III XL Emulation menu 168

- Auto LF (continued)
 - pSeries Emulation menu 173
 - pSeries XQ Emulation menu 176
 - Serial Matrix Emulation menu 180
- Auto Trickle
 - Dataproducts menu
 - PC Parallel menu 124
 - IEEE 1284 menu 125
 - Parallel Interface menu
 - PC Parallel menu 121

B

- B10 ERROR: NO DRAM DETECTED* 233
- B11 ERROR: RAM TEST FAILED* 233
- B12 ERROR: PROGRAM MISSING* 233
- B13 ERROR: NOT COMPATIBLE* 233
- B19 ERROR: DC RETURNED* 233
- B20 STATUS: 00% DOWNLOAD MODE 234
- B21 STATUS: PRINTER RESET 234
- B22 ERROR: DECOMPRESS SIZE* 234
- B23 ERROR: DECOMPRESS CKSUM* 234
- B30 - STATUS:INITIALIZING 234
- B35 STATUS: WAITING FOR EC STATUS 234
- B40 ERROR: SDRAM EEPROM CKSUM BAD* 234
- B41 ERROR: DIMM MEMORY NOT SDRAM* 234
- B42 ERROR: SDRAM ROWS NOT ALLOWED* 234
- B43 ERROR: SDRAM TOO MANY BANKS* 234
- B44 ERROR: SDRAM NOT 64 BITS WIDE* 234
- B45 ERROR: SDRAM IS WRONG VOLTAGE* 234
- B46 ERROR: SDRAM HAS MIXED SIZES* 234
- B47 ERROR: SDRAM LARGER THAN 256M* 234
- B49 ERROR: SDRAM # LOGICAL BANKS* 235
- B50 ERROR: SDRAM LOGIC COMB BANKS* 235
- Bar Code Errors
 - Code V Configuration menu
 - Error Handling 163
- Bar Code Quality
 - IPDS Configuration menu 138
- Barcode Darkmode
 - ANSI menu
 - Page Format 149
- Baud Rate
 - Serial Interface menu 128
- BC Check Digit
 - ANSI menu
 - Page Format 149
- Bold Print
 - ANSI menu
 - Font Attributes 145
- Bottom Margin
 - Print Format menu
 - Margins 188

- Buffer Clear
 - Dataproducts Parallel Interface Signals 201
- Buffer Reprint
 - Coax Interface menu 70
- Buffer Size in Kbytes
 - Dataproducts menu
 - PC Parallel menu 123
 - Ethernet Parameters Submenu
 - Network Setup menu 106
 - IEEE 1284 menu 125
 - Serial Interface menu 130
- Buffer Size in Kilobytes
 - Adapter Parameters Submenu
 - Network Setup menu 101
 - Parallel Interface menu
 - PC Parallel menu 121
- Built-in diagnostic tools 7
- Busy on Strobe
 - Parallel Interface menu
 - PC Parallel menu 120
- Busy, PC Parallel Interface Signals 199
- Byte Mode, IEEE 1284 Parallel Interface 203

C

- C/T Hotport
 - 3270 Interface menu 92
 - 5250 Interface menu 85
 - Coax Interface menu 74
 - Twinax Interface menu 65
- Cable Verify
 - Dataproducts Parallel Interface Signals 201
- cables 260
- CALIBRATE TRANSPORT PRESS ENTER KEY* 235
- CALIBRATING TRANSPORT PLEASE WAIT... 235
- CALIBRATION ERROR SEE USER'S MANUAL 235
- Cancel buffers
 - Twinax Interface menu 61
- Cancel Buffers
 - Coax Interface menu 71
- Change parameters 30
- Change power on configuration 37
- Change power on set, Configuration Management menu 56
- Channel
 - Wireless Parameters menu 110
- Character Filtering
 - Code V Configuration menu 163
 - Data Bit 8 164
 - Ignore Characters 163
 - Select Character 1 164
 - Select Character 2 164
- character formation, line matrix printing 263
- Character Set
 - ANSI menu
 - Page Format 148
- Character Sets
 - Epson Emulation menu 170
 - pSeries Emulation menu 173
 - Serial Matrix Emulation menu 179

- characteristics
 - electrical 257
 - environmental 256
- Characters per inch
 - Print Format menu 182
- cleaning
 - inside of cabinet 212
 - outside of cabinet 211
- Clear to Send (CTS), RS-232 195
- CLEARING PROGRAM FROM FLASH 235
- Clock Skew
 - Wireless Kerberos menu 114
- Coax Interface menu 67
 - Active Print Language 69
 - Alternate Set 80 - 9F 72
 - Buffer Reprint 70
 - C/T Hotport 74
 - Cancel Buffers 71
 - Compatibility Options 73
 - Compatibility Options menu 76
 - Compatibility Option 1:Carriage Return at MPP+1 76
 - Compatibility Option 10:Bottom Margin (SCS data stream only) 79
 - Compatibility Option 2:New Line at MPP+1 77
 - Compatibility Option 3:Position After Form Feed (4234 only) 77
 - Compatibility Option 4:Form Feed at End of Print Buffer 77
 - Compatibility Option 5:Null Suppression 77
 - Compatibility Option 6:Form Feed Command Position 78
 - Compatibility Option 7:Automatic Form Feed at End of Print Buffer 78
 - Compatibility Option 8:Automatic FF After Operator-Initiated Copy 78
 - Compatibility Option 9:CR, EM, and NL (3287 only) 79
 - Early Print Complete 70
 - Format Control 74
 - Hex Print Mode 75
 - Hex Transparent Control 71
 - Image Buffer Size 73
 - Intervention Required 73
 - Lead-In Characters 71
 - Maximum Printable Width 75
 - Mono/Dual Case 72
 - Override Host 73
 - PA1 69
 - PA2 70
 - Port Type 74
 - Print character table 69
 - Print language 69
 - Print Text Direction 72
 - Report Status 74
 - SCS Buffer Control 71
 - Timeout 74
 - Undefined Char Sub 72
 - User Defined Codes 71
- Code V
 - configuration 156

- Code V (continued)
 - parameters 156
- Code V Configuration menu 157
 - Character Filtering 163
 - Data Bit 8 164
 - Ignore Characters 163
 - Select Character 1 164
 - Select Character 2 164
 - Error Handling 162
 - Bar Code Errors 163
 - Error Markers 163
 - Error Messages 162
 - Off Page Errors 163
 - Font Set 165
 - Graphics Option 160
 - Absorb at ^PN 162
 - Absorb at ^PY 160
 - Append Rotated 160
 - Dark Barcode 161
 - Expanded Font 161
 - Ignore Dots Value 160
 - Ignore Spaces 161
 - IGP110 Compatibility 162
 - Inline Graphics 162
 - LP+ Font 161
 - Midline PY 161
 - Rotate Character Size 161
 - Slashed Zero 160
 - True Vertical 1/10 160
 - Truncate Off Page Alpha 160
 - UPC Descenders 161
 - Width Limit 162
 - LF For Term 162
 - Lines Per Inch 159
 - PI Control 165
 - Host PI 165
 - PI Slew Range 166
 - Printer PI 165
 - SFCC and Power On 158
 - Code V SFCC 158
 - Power On ^F 159
 - Power On ^PY 159
 - Power On ^X 159
- Code V SFCC
 - Code V Configuration menu
 - SFCC and Power On 158
- compatibility and limitations 268
- Compatibility Mode, IEEE 1284 Parallel Interface 202
- Compatibility Option 1:Carriage Return at MPP+1
 - Compatibility Options menu
 - 3270 Interface menu 94
 - Coax Interface menu 76
- Compatibility Option 10:Bottom Margin (SCS data stream only)
 - Compatibility Options menu
 - 3270 Interface menu 97
 - Coax Interface menu 79
- Compatibility Option 2:New Line at MPP+1
 - Compatibility Options menu
 - 3270 Interface menu 95
 - Coax Interface menu 77
- Compatibility Option 3:Position After Form Feed (4234 only)
 - Compatibility Options menu
 - 3270 Interface menu 95
 - Coax Interface menu 77
- Compatibility Option 4:Form Feed at End of Print Buffer
 - Compatibility Options menu
 - 3270 Interface menu 95
 - Coax Interface menu 77
- Compatibility Option 5:Null Suppression
 - Compatibility Options menu
 - 3270 Interface menu 95
 - Coax Interface menu 77
- Compatibility Option 6:Form Feed Command Position
 - Compatibility Options menu
 - 3270 Interface menu 96
 - Coax Interface menu 78
- Compatibility Option 7:Automatic Form Feed at End of Print Buffer
 - Compatibility Options menu
 - 3270 Interface menu 96
 - Coax Interface menu 78
- Compatibility Option 8:Automatic FF After Operator-Initiated Copy
 - Compatibility Options menu
 - 3270 Interface menu 96
 - Coax Interface menu 78
- Compatibility Option 9:CR, EM, and NL (3287 only)
 - Compatibility Options menu
 - 3270 Interface menu 97
 - Coax Interface menu 79
- Compatibility Options
 - Coax Interface menu 73
 - Translate Table 73
- Compatibility Options menu
 - 3270 Interface menu 94
 - Compatibility Option 1:Carriage Return at MPP+1 94
 - Compatibility Option 10:Bottom Margin (SCS data stream only) 97
 - Compatibility Option 2:New Line at MPP+1 95
 - Compatibility Option 3:Position After Form Feed (4234 only) 95
 - Compatibility Option 4:Form Feed at End of Print Buffer 95
 - Compatibility Option 5:Null Suppression 95
 - Compatibility Option 6:Form Feed Command Position 96
 - Compatibility Option 7:Automatic Form Feed at End of Print Buffer 96
 - Compatibility Option 8:Automatic FF After Operator-Initiated Copy 96
 - Compatibility Option 9:CR, EM, and NL (3287 only) 97
 - Coax Interface menu 76
 - Compatibility Option 1:Carriage Return at MPP+1 76
- Compatibility Options menu (continued)
 - Coax Interface menu (continued)
 - Compatibility Option 10:Bottom Margin (SCS data stream only) 79
 - Compatibility Option 2:New Line at MPP+1 77
 - Compatibility Option 3:Position After Form Feed (4234 only) 77
 - Compatibility Option 4:Form Feed at End of Print Buffer 77
 - Compatibility Option 5:Null Suppression 77
 - Compatibility Option 6:Form Feed Command Position 78
 - Compatibility Option 7:Automatic Form Feed at End of Print Buffer 78
 - Compatibility Option 8:Automatic FF After Operator-Initiated Copy 78
 - Compatibility Option 9:CR, EM, and NL (3287 only) 79
- compatibility, host attachment 268
- Component locations, printer 16
- Compressed CPI
 - IGP Emulation menu 154
- Compressed Font
 - IPDS Configuration menu 141
- Compressed Print
 - pSeries XQ Emulation menu 176
- configuration
 - IPDS 134
- Configuration
 - Code V 156
 - IGP 150
 - main menu 20
 - overview 39
 - printout 29
 - saving in a custom set 32
- Configuration Management menu 54
 - Change power on set 56
 - Delete custom set 56
 - Name Custom Sets 57
 - Print custom set values 57
 - Protect custom sets 56
 - Protect Custom Sets 56
 - Recall custom set 55
 - Save current values 56
- Configuration overview, printer 11
- Control Code 06
 - pSeries Emulation menu 173
 - pSeries XQ Emulation menu 175
 - Serial Matrix Emulation menu 179
- Control Code 08
 - pSeries Emulation menu 173
- control unit
 - 6500-LU0-DSC-Local Non-SNA 3174 284
 - 6500-LU3-DSE-Remote SNA 3174 282
- Control unit
 - 6500-LU1-SCS-Local SNA-3174 277
 - 6500-LU3-DSE-Local SNA 3174 281
- CPI/LPI Select
 - ANSI menu 144
- CR Edit
 - IGP Emulation menu 152

Current configuration, print 28
Custom sets, load 35

D

Dark Barcode
Code V Configuration menu
Graphics Option 161

Data Bit 8
Code V Configuration menu
Character Filtering 164

Dataproducts menu
PC Parallel menu 122

Parallel Interface menu
PC Parallel menu 119

Data Bits
Serial Interface menu 128

Data Carrier Detect (DCD), RS-232 195

Data Lines 1 through 8
Dataproducts Parallel Interface
Signals 201
PC Parallel Interface Signals 199

Data Polarity
Dataproducts menu
PC Parallel menu 123

Parallel Interface menu
PC Parallel menu 120

Data Protocol
Serial Interface menu 128

Data Request Polarity
Dataproducts menu
PC Parallel menu 123

Data Set Ready (DSR), RS-232 195

Data Strobe
Dataproducts Parallel Interface
Signals 201
PC Parallel Interface Signals 199

Data Terminal Ready
Serial Interface menu 129

Data Terminal Ready (DTR)
RS-232 195

Dataproducts
Parallel Interface menu 117

Dataproducts menu
PC Parallel menu 122
Auto Trickle 124
Buffer Size in Kbytes 123
Data Bit 8 122
Data Polarity 123
Data Request Polarity 123
PI Ignored 123
Strobe Polarity 123
Trickle Time 124

Dataproducts Parallel Interface 200

Dataproducts Parallel Interface
Configuration 201

Dataproducts Parallel Interface
Signals 201
Buffer Clear 201
Cable Verify 201
Data Lines 1 through 8 201
Data Strobe 201
Demand/Data Request 201
Online 201
Paper Instruction (PI) 201
Parity Error 201
Ready 201

Default WEP Key
Wireless Parameters menu 111, 112

Define CR Code
ANSI menu
Page Format 147

Define CR Code (Carriage Return)
Epson Emulation menu 170
IGP Emulation menu 151
Proprinter III XL Emulation
menu 168
pSeries Emulation menu 173
pSeries XQ Emulation menu 176
Serial Matrix Emulation menu 179

Define LF Code
ANSI menu
Page Format 148
pSeries Emulation menu 174

Define LF Code (Line Feed)
Epson Emulation menu 170
IGP Emulation menu 152
Proprinter III XL Emulation
menu 168
pSeries XQ Emulation menu 176
Serial Matrix Emulation menu 180

Delete custom set, Configuration
Management menu 56

Demand/Data Request, Dataproducts
Parallel Interface Signals 201

DHCP
Adapter Address Submenu
Network Setup menu 100

Ethernet Address Submenu
Network Setup menu 105

Wireless Address Menu
Network Setup menu 108

DIAGNOSTIC PASSED 235

Diagnostic tools 7

diagnostics
overview 211

dimensions, printer 255

Dimensions, printer 14

Display language, Printer Control
menu 47

DO NOT POWER OFF
DOWNLOADING 235

DP FIFO BUSY* 235

DRIVER CIRCUIT BAD 235

E

E NET TEST UNAVAILABLE 244

E00 EXE @ ADDR0 235

E01A TYPE 0x40 236

E01B TYPE 0x60 236

E02 MACHINE CHK 236

E03A DSI HASH L 236

E03B DSI HASH S 236

E03C DSI BAT PL 237

E03D DSI BAT PS 237

E03E DSI CXIWX 237

E03F DSI CXOWX 237

E03G DSI ECXIWX 237

E03H DSI ECXOWX 238

E04A ISI NO TRA 238

E04B ISI DIRECT 238

E04C ISI PROTEC 238

E06 NOT ALIGNED 238

E07 ILLEGAL INS 239

E08 FLOATINGPNT 239

E12 SYSTEM CALL 239

E13 TRACE INT 239

E16 ITRANS MISS 239

E17 DLOAD MISS 240

E18 DSTORE MISS 240

E19 BREAKPOINT 240

E20 SYS MANAGE 240

E30 DEBUGGER 240

E31A EVENT 0 BP 241

E31B EVENT 1 BP 241

E31C EVENT 2 BP 241

E31D EVENT 3 BP 241

E31E EVENT 4 BP 241

E31F EVENT 5 BP 242

E31G EVENT 6 BP 242

E31H EVENT 7 BP 242

E32A CND 0 BP 242

E32B CND 1 BP 242

E32C CND 2 BP 243

E32D CND 3 BP 243

E32E CND 4 BP 243

E32F CND 5 BP 243

E32G CND 6 BP 243

E32H CND 7 BP 244

E33 WRITE BP 244

E34 TRACE CMPLT 244

E99 UNKNOWN INT 244

Early print complete
Twinax Interface menu 61

Early Print Complete
3270 Interface menu 89
Coax Interface menu 70

Eject Restore, Printer Control menu 50

electrical characteristics 257
input voltage 257
power consumption 257

Elong/Alt. Font
pSeries XQ Emulation menu 176

Emulation Configuration menu 133
Active Emulation 134
ASCII Printer Emulation 134
Code V Feature (VGL) 156
IGP Feature (PGL) 150
Print Format 134
Printer Emulation Configuration 134

Emulations, printer 5, 9

ENERGY SAVER MODE ACTIVE 244

Energy saver timer, Printer Control
menu 49

Enhanced Bar Code Mode
IPDS Configuration menu 140

Entering, program mode 28

environmental characteristics 256

Epson Emulation menu 169
20 CPI Condensed 171
Auto LF 170
Character Sets 170
Define CR Code (Carriage
Return) 170
Define LF Code (Line Feed) 170
Epson Print Language 170
Printer Select 170

Epson Print Language
Epson Emulation menu 170

- Error Handling
 - Code V Configuration menu 162
 - Bar Code Errors 163
 - Error Markers 163
 - Error Messages 162
 - Off Page Errors 163
- Error Markers
 - Code V Configuration menu
 - Error Handling 163
- Error messages 221
- Error Messages
 - Code V Configuration menu
 - Error Handling 162
- ERROR: DC PROGRAM NOT VALID 245
- ERROR: EC STOPPED AT STATE XXXX 245
- ESC c Sequence
 - ANSI menu
 - Page Format 148
- Ethernet Address Submenu
 - Network Setup menu 104
 - DHCP 105
 - Gateway Address 104
 - IP Address 104
 - MAC Address 104
 - Subnet Mask 104
- Ethernet Hotport
 - Adapter Parameters Submenu
 - Network Setup menu 103
 - Ethernet Parameters Submenu
 - Network Setup menu 107
- Ethernet Parameters Submenu
 - Network Setup menu 105
 - ASCII Data Port Number 106
 - Buffer Size in Kbytes 106
 - Ethernet Hotport 107
 - Ethernet Speed 107
 - IPDS Data Port Number 106
 - Job Control 107
 - Keep Alive Timer 106
 - NetBIOS Protocol 106
 - Timeout 107
- Ethernet Speed
 - Adapter Parameters Submenu
 - Network Setup menu 102
 - Ethernet Parameters Submenu
 - Network Setup menu 107
- Ethernet Test Page
 - Operator Print Tests menu 190
- ETX/ACK (TBD)
 - ANSI menu
 - Page Format 150
- EVFU select
 - pSeries XQ Emulation menu 177
- EVFU Select
 - pSeries Emulation menu 174
- Expanded Font
 - Code V Configuration menu
 - Graphics Option 161
 - IGP Emulation menu 155
- Ext Execute Copy
 - IGP Emulation menu 154

F

- Factory default values, load 35
- Fault correction procedure 221
- Fault messages 221
- Features, printer 1
- FF Valid At TOF
 - Proprinter III XL Emulation menu 168
- File system, Printer Control menu 51
- Font Attributes
 - ANSI menu
 - Bold Print 145
 - Prop. Spacing (Proportional Spacing) 145
 - Slashed Zero 145
 - Typeface 144
- Font Set
 - Code V Configuration menu 165
- Form Length
 - ANSI menu
 - Page Format 146
- Form Width
 - ANSI menu
 - Page Format 146
- Format control
 - Twinax Interface menu 64
- Format Control
 - 3270 Interface menu 92
 - 5250 Interface menu 85
 - Coax Interface menu 74
- Forms length
 - IGP Configuration menu 184
 - Print Format menu
 - Forms Length In Inches 185
 - Forms Length In Lines 185
 - Forms Length In MM 185
 - Forms Length In Inches
 - Print Format menu
 - Forms length 185
 - Forms Length In Lines
 - Print Format menu
 - Forms length 185
 - Forms Length In MM
 - Print Format menu
 - Forms length 185
- Forms speed, Printer Control menu 48
- Forms Width
 - Print Format menu 183
 - Forms Width In Characters 183
 - Forms Width In Inches 183
 - Forms Width In MM 183
 - Forms Width In Characters
 - Print Format menu
 - Print Format menu 183
 - Forms Width In Inches
 - Print Format menu
 - Forms Width 183
 - Forms Width In MM
 - Print Format menu
 - Forms Width 183
- Framing Errors
 - Serial Interface menu 132
- FREEFORM OFF 245
- FREEFORM ON:OFF HOLD KEY @ PWRUP 245

G

- Gateway Address
 - Adapter Address Submenu
 - Network Setup menu 99
 - Ethernet Address Submenu
 - Network Setup menu 104
 - Wireless Address Menu
 - Network Setup menu 108
- Glossary Section
 - References 297
- graphics 7
- Graphics enhancements 9
- Graphics Option
 - Code V Configuration menu 160
 - Absorb at ^PN 162
 - Absorb at ^PY 160
 - Append Rotated 160
 - Dark Barcode 161
 - Expanded Font 161
 - Ignore Dots Value 160
 - Ignore Spaces 161
 - IGP110 Compatibility 162
 - Inline Graphics 162
 - LP+ Font 161
 - Midline PY 161
 - Rotate Character Size 161
 - Slashed Zero 160
 - True Vertical 1/10 160
 - Truncate Off Page Alpha 160
 - UPC Descenders 161
 - Width Limit 162
- Graphics Quality
 - IPDS Configuration menu 138

H

- H/B CONTROL MODE 246
- H00: PCI SLOT ? 245
- H01: PCI J12 245
- H02: PCI J13 245
- HAMMER COIL BAD 246
- Hex code printout 217
- Hex print mode
 - Printer Control menu 48
 - Twinax Interface menu 65
- Hex Print Mode
 - Coax Interface menu 75
- Hex transparent control
 - Twinax Interface menu 62
- Hex Transparent Control
 - 3270 Interface menu 89
 - 5250 Interface menu 82
 - Coax Interface menu 71
- High Speed Print Mode
 - pSeries XQ Emulation menu 176
- HMR BANK NOT INSTALLED 246
- host attachment 267
 - compatibility 268
 - limitations 270
- Host computer interfaces 4
- Host PI
 - Code V Configuration menu
 - PI Control 165
- humidity requirements 256

- I**
- IBM System i
 - attach system 273
 - change printer configuration 274
 - with auto configuration 274
 - Twinax interface, attach printer 273
- IBM System i, attach printer 273
- IEEE 1284
 - Parallel Interface menu 117
- IEEE 1284 menu 125
 - Auto Trickle 125
 - Buffer Size in Kbytes 125
 - Trickle Time 126
- IEEE 1284 Parallel Interface 202
 - Byte Mode 203
 - Compatibility Mode 202
 - negotiation phase 203
 - Nibble Mode 202
 - operating modes 202
 - Signals 203
- Ignore Character
 - Ignore Mode
 - IGP Emulation menu 155
 - IGP Emulation menu 155
 - Select Character
 - IGP Emulation menu 155
- Ignore Characters
 - Code V Configuration menu
 - Character Filtering 163
- Ignore Dots Value
 - Code V Configuration menu
 - Graphics Option 160
- Ignore Mode
 - Ignore Character
 - IGP Emulation menu 155
- Ignore Spaces
 - Code V Configuration menu
 - Graphics Option 161
- IGP
 - configuration 150
 - parameters 150
- IGP Configuration menu
 - Forms length 184
- IGP Emulation menu 151
 - Auto LF 152
 - Compressed CPI 154
 - CR Edit 152
 - Define CR Code (Carriage Return) 151
 - Define LF Code (Line Feed) 152
 - Expanded Font 155
 - Ext Execute Copy 154
 - Ignore Character 155
 - Ignore Mode 155
 - Select Character 155
 - IGP100 Compatibility 155
 - Lines Per Inch 153
 - Mono/Dual Case 153
 - Optimized Ratio 155
 - PI Slew Range 152
 - Power On IGP 154
 - Select Font 153
 - Select Set 152
 - Select SFCC 152
 - Skip Command Prefix 154
 - Slash 0 153
 - UPC Descenders 154
- IGP100 Compatibility
 - IGP Emulation menu 155
- IGP110 Compatibility
 - Code V Configuration menu
 - Graphics Option 162
- ILL INST ACCSS* 246
- Image Buffer Size
 - Coax Interface menu 73
- Image Quality
 - IPDS Configuration menu 139
- INCOMPAT E-NET 246
- Inline Graphics
 - Code V Configuration menu
 - Graphics Option 162
- input voltage 257
- Installation
 - printer 11
- Installed Memory
 - Printer Information menu 191
- installing resistors 207
- INTAKE FAN FAULT 246
- Interface selection, Printer Control menu 47
- Interface Type
 - Parallel Interface menu 117
 - Serial Interface menu 128
- interfaces 260
- Interfaces
 - printer 193
- International Mode
 - Wireless Parameters menu 111
- INTERRUPT UNUSED VECTOR 00 246
- Intervention Required
 - 3270 Interface menu 91
 - Coax Interface menu 73
- IP Address
 - Adapter Address Submenu
 - Network Setup menu 99
 - Ethernet Address Submenu
 - Network Setup menu 104
 - Wireless Address Menu
 - Network Setup menu 108
- IPDS
 - configuration 134
 - parameters 135
- IPDS Configuration menu 135
 - Bar Code Quality 138
 - Compressed Font 141
 - Enhanced Bar Code Mode 140
 - Graphics Quality 138
 - Image Quality 139
 - IPDS Emulation Mode 139
 - Maximum Printable Width (TCP/IP IPDS) 137
 - Override Host (Emulation Configuration) 138
 - Postnet Barcode Width 140
 - Print Language (TCP/IP IPDS) 137
 - Undefined Character Substitution (TCP/IP IPDS) 137
 - UPC/EAN Barcode HRI 140
- IPDS Data Port Number
 - Adapter Parameters Submenu
 - Network Setup menu 102
 - Ethernet Parameters Submenu
 - Network Setup menu 106
- IPDS Emulation Mode
 - IPDS Configuration menu 139
- iSeries
 - change printer configuration settings 275
- Italic Print
 - Print Format menu
 - Print Attributes 186
- J**
- Job Control
 - Adapter Parameters Submenu
 - Network Setup menu 102
 - Ethernet Parameters Submenu
 - Network Setup menu 107
- K**
- KDC Port Number
 - Wireless Kerberos menu 114
- Keep Alive Timer
 - Adapter Parameters Submenu
 - Network Setup menu 102
 - Ethernet Parameters Submenu
 - Network Setup menu 106
- Kerberos Enable
 - Wireless Kerberos menu 113
- Kerberos Password
 - Wireless Kerberos menu 114
- L**
- labels
 - specifications 255
- LAC approximation, Twinax Interface menu 63
- Latch Data On
 - Parallel Interface menu
 - PC Parallel menu 120
- Lead-In Characters
 - 3270 Interface menu 90
 - 5250 Interface menu 83
 - Coax Interface menu 71
- LEAP Password
 - Wireless LEAP menu 116
- LEAP Username
 - Wireless LEAP menu 116
- Left Margin
 - Print Format menu
 - Margins 188
- LF For Term
 - Code V Configuration menu 162
- limitations and compatibility 268
- Limitations, host attachments 270
- line matrix printing
 - character formation 263
 - theory 263
- Lines Per Inch
 - Code V Configuration menu 159
 - IGP Emulation menu 153
 - Print Format menu 182
- Load
 - custom sets 35
 - factory default values 35

- Load alternate character option, Twinax Interface menu 63
- LOADING PROGRAM FROM PORT XX% 246
- LOADING PROGRAM INTO FLASH 246
- Locking, program mode 28
- logical unit type 286
- LP+ Font
 - Code V Configuration menu
 - Graphics Option 161
- LU type 0 287
- LU type 1 287
- LU type 2 287
- LU type 3 288
- LU type 4 288
- LU type 6.1 288
- LU type 6.2 288
- LU type 7 288
- LU types, summary 287

M

- MAC Address
 - Adapter Address Submenu
 - Network Setup menu 99
 - Ethernet Address Submenu
 - Network Setup menu 104
 - Wireless Address Menu
 - Network Setup menu 108
- Main menu 40
 - Configuration Management 54
 - Configuration Management menu
 - Protect Custom Sets 56
- Maintenance 10
- Margins
 - ANSI menu
 - Page Format 146
 - Print Format menu 187
 - Bottom Margin 188
 - Left Margin 188
 - Right Margin 188
- Maximum printable width
 - Twinax Interface menu 65
- Maximum Printable Width
 - 3270 Interface menu 93
 - 5250 Interface menu 85
 - Coax Interface menu 75
- Maximum Printable Width (TCP/IP IPDS)
 - IPDS Configuration menu 137
- Menu
 - ANSI 142
 - Coax Interface 67
 - Coax Interface menu
 - Compatibility Options 76
 - Code V Configuration 157
 - Emulation Configuration 133
 - Epson Emulation 169
 - IEEE 1284 menu 125
 - IGP Emulation menu 151
 - IPDS Configuration 135
 - Main 40
 - Network Setup menu 98
 - Adapter Address Submenu 99
 - Adapter Parameters Submenu 100

- Menu (*continued*)
 - Network Setup menu (*continued*)
 - Ethernet Address Submenu 104
 - Ethernet Parameters Submenu 105
 - Wireless Address Menu 108
 - Operator Print Tests 189
 - Parallel Interface 117
 - Parallel Interface menu
 - PC Parallel Menu 119
 - PC Parallel menu
 - Dataproducs menu 122
 - Print format 181
 - Printer Control 45
 - Printer Emulation Configuration 166
 - Printer Information 191
 - Proprieter III XL Emulation 167
 - pSeries Emulation 171
 - pSeries XQ Emulation 175
 - Serial Interface 127
 - Serial Matrix Emulation 178
 - Twinax Interface 58
 - Wireless Kerberos 113
 - Wireless LEAP 115
 - Wireless Parameters menu 109
- menus
 - Configuration Management 54
- Messages
 - 001 END OF FORMS 222
 - 002 FORMS JAMMED 222
 - 003 FORMS EJECTED 222
 - 004 VIEW FORMS 222
 - 006 HOST SYSTEM REQUESTS
 - ATTN 222
 - 007 FM HEADER ERROR 222
 - 008 HOLD PRINT TIMEOUT 222
 - 009 INVALID KEYPRESS 222
 - 010 PARAMETER ERROR 222
 - 011 SCS COMMAND ERROR 222
 - 012 STRUCTURED FLD ERROR 222
 - 013 ACTIVATE LOST 222
 - 014 INVALID ACTIVATE 222
 - 015 COMMUNICATION
 - CHECK 223
 - 016 INVALID COMMAND 223
 - 017 STACKER JAM 223
 - 018 STACKER FULL 223
 - 019 STACKER FAULT 223
 - 021 PRINT BUFFER OVERRUN 223
 - 022 UNIT ADDRESS INVALID 223
 - 024 SERIAL LINE PARITY
 - ERROR 223
 - 025 FRAMING ERROR 223
 - 026 HEX DUMP MODE 223
 - 027 COMMUNICATIONS
 - CHECK 223
 - 028 COMMUNICATIONS
 - CHECK 223
 - 029 8344 DIAGNOSTIC TEST
 - FAILED 224
 - 031 END OF FORMS TIMEOUT 224
 - 032 FORMS JAMMED
 - TIMEOUT 224
 - 034 TRNSPT STALL TIMEOUT 224
 - 035 RIBBON OUT OF INK 224
 - 037 STACKER JAM TIMEOUT 224
 - 038 STACKER FULL TIMEOUT 224

- Messages (*continued*)
 - 039 STACKER FAULT 224
 - 041 BUFFER OVERFLOW 224
 - 042 NO CUSTOM SET AVAIL 224
 - 043 CUSTOM SET ALREADY EXISTS 225
 - 044 EC FIRMWARE/HARDWARE ERROR 225
 - 045 FIRMWARE ERROR* 225
 - 046 EC STOPPED AT STATE 225
 - 051 HAMMER SHORT* 225
 - 052 MECH DRIVER HOT 225
 - 053 48 VOLTS FAILED* 225
 - 054 HAMMER COIL SHORT* 225
 - 055 MECH. DRIVER LINK FAILURE 225
 - 056 HAMMER COIL OPEN 225
 - 057 CLOSE PLATEN 225
 - 058 SHUTTLE JAM 225
 - 059 CANCEL PRINT ACTIVE 225
 - 060 PRINTER HOT 225
 - 062 EXHAUST FAN CHECK* 226
 - 065 HAMMER FAN CHECK* 226
 - 069 DATA CLEARED 226
 - 080 POWER SUPPLY HOT 226
 - 081 POWER VOLT CHECK* 226
 - 082 POWER 8.5V CHECK* 226
 - 083 INTAKE FAN CHECK* 226
 - 084 POWER 48V CHECK* 226
 - 085 CONTROL VOLT CHECK 227
 - 086 CONTROL 15V CHECK* 227
 - 087 PLATEN OPEN TIMEOUT 227
 - 088 CONTROL 23.5V CHECK* 227
 - 089 RIBBON STALL CHECK
 - TRANSPORT 227
 - 090 SHUTTLE COVER OPEN 227
 - 092 TRNSPT DRVR CIRCUIT 227
 - 101 UPPER DRIVER SHORT* 227
 - 102 LOWER DRIVER SHORT* 227
 - 104 ERROR:DP FIFO BUSY 227
 - 105 HAMMER <#> CHECK 227
 - 110 STACK OVERFLOW* 227
 - 111 STACK UNDERFLOW* 227
 - 112 UNDEFINED OPCODE* 228
 - 113 INSTRUCTION SET 228
 - 114 ILLGL OPR ACCESS 228
 - 115 ILLGL INSTRACCESS* 228
 - 116 ILLEGAL BUS ACCESS 228
 - 117 A TO D OVERUN* 228
 - 118 UNDEFINED INTERRUPT 228
 - 119 TCB CORRUPTED* 228
 - 120 MACHINE CHECK* 228
 - 121 PAPER NOT AT SPEED 228
 - 122 PAPER NOT SCHEDULED 228
 - 123 PAPER BUSY TOO LONG 228
 - 124 PAPER FIFO OVERFLOW 228
 - 125 PAPER FIFO UNDERFLOW 228
 - 126 FEED TABLE CHECK 228
 - 127 ILLEGAL STATE 228
 - 128 ILLEGAL COMMAND 229
 - 129 INVALID PARAMETER 229
 - 130 PAP FEED INCOMPLETE 229
 - 131 PAPER FEED INTERRUPT 229
 - 132 RIBBON INVALID
 - COMMAND 229
 - 133 PAPER NOT SCHEDULED* 229
 - 134 INVALID COMMAND 229

Messages (continued)

135 INVALID STATE* 229
 136 INVALID PARAMETER 229
 137 SHUTL INVALID
 COMMAND* 229
 138 SHUTTLE INVALID
 PARAMETER 229
 139 OVER SPEED CHECK* 229
 140 48 VOLTS FAILED* 229
 142 PAP FEED DRIVE FAIL* 229
 143 SHUTL DRIVER FAILED* 230
 144 SHUTTLE FAN FAILURE* 230
 146 RIBBON INK OUT INSTALL
 NEW INFOPRINT RIBBON 230
 147 H/B CONTROL MODE 230
 148 DRIVER CIRCUIT BAD 230
 149 HMR BANK NOT
 INSTALLED 230
 150 ERROR: EC STOPPED AT STATE
 XXXX 230
 159 HAMMERBANK HOT 230
 160 ERROR: DC PROGRAM NOT
 VALID 230
 161 ERROR: DRAM AT ADDRESS
 XXXXXXXX 230
 162 ERROR: EC PROGRAM NOT
 VALID 230
 163 ERROR: FLASH DID NOT
 PROGRAM 230
 164 ERROR: SDRAM JEDEC
 MISSING 230
 165 ERROR: NO DRAM
 DETECTED 231
 166 ERROR: NVRAM FAILURE 231
 167 ERROR: PROGRAM NEEDS
 MORE DRAM 231
 168 ERROR: PROGRAM NEEDS
 MORE FLASH 231
 169 ERROR: PROGRAM NOT
 COMPATIBLE 231
 170 ERROR: PROGRAM NOT
 VALID 231
 171 ERROR: SHORT AT ADDRESS
 XXXX 231
 172 ERROR: WRITING TO
 FLASH 231
 173 ERROR: WRONG
 CHECKSUM 231
 174 ERROR OCCURRED FLUSHING
 QUEUES* 231
 175 ACCESS NULL POINTER* 231
 180 ETHERNET ADDRESS ADAPTER
 NOT INSTALLED 231
 181 ETHERNET ADAPTER BEING
 INITIALIZED 231
 182 ETHERNET DETECTED 231
 190 SECURITY ERROR 232
 191 SECURITY CODE
 VIOLATION 232
 192 SECURITY KEY NOT
 DETECTED 232
 194 INCOMPAT. E-NET NIC
 REPLACE NIC 232
 195 INCOMPAT. WLAN NIC
 REPLACE NIC 232
 200 SOFTWARE ERROR* RECYCLE
 POWER 232

Messages (continued)

301 RIBBON INK LOW 232
 302 EXCESSIVE RIBBON WEAR 232
 303 BARCODE NOT DETECTED 232
 304 BARCODE DAMAGED 232
 305 OLD RIBBON DETECTED 232
 306 UNKNOWN RIBBON 232
 307 UNKNOWN RIBBON 232
 308 BARCODE SENSOR ERR 233
 48V CIRCUIT* 233
 733 DP FIFO BUSY* 233
 990 MACHINE CHECK 233
 990 NV-RAM CHECK 233
 A97 GRAPHIC CHECK ERROR 233
 B10 ERROR: NO DRAM
 DETECTED* 233
 B11 ERROR: RAM TEST
 FAILED* 233
 B12 ERROR: PROGRAM
 MISSING* 233
 B13 ERROR: NOT
 COMPATIBLE* 233
 B19 ERROR: DC RETURNED* 233
 B20 STATUS: 00% DOWNLOAD
 MODE 234
 B21 STATUS: PRINTER RESET 234
 B22 ERROR: DECOMPRESS
 SIZE* 234
 B23 ERROR: DECOMPRESS
 CKSUM* 234
 B30 - STATUS:INITIALIZING 234
 B35 STATUS: WAITING FOR EC
 STATUS 234
 B40 ERROR: SDRAM EEPROM
 CKSUM BAD* 234
 B41 ERROR: DIMM MEMORY NOT
 SDRAM* 234
 B42 ERROR: SDRAM ROWS NOT
 ALLOWED* 234
 B43 ERROR: SDRAM TOO MANY
 BANKS* 234
 B44 ERROR: SDRAM NOT 64 BITS
 WIDE* 234
 B45 ERROR: SDRAM IS WRONG
 VOLTAGE* 234
 B46 ERROR: SDRAM HAS MIXED
 SIZES* 234
 B47 ERROR: SDRAM LARGER THAN
 256M* 234
 B49 ERROR: SDRAM # LOGICAL
 BANKS* 235
 B50 ERROR: SDRAM LOGIC COMB
 BANKS* 235
 CALIBRATE TRANSPORT PRESS
 ENTER KEY* 235
 CALIBRATING TRANSPORT PLEASE
 WAIT... 235
 CALIBRATION ERROR SEE USER'S
 MANUAL 235
 CLEARING PROGRAM FROM
 FLASH 235
 DIAGNOSTIC PASSED 235
 DO NOT POWER OFF
 DOWNLOADING 235
 DP FIFO BUSY* 235
 DRIVER CIRCUIT BAD 235
 E NET TEST UNAVAILABLE 244

Messages (continued)

E00 EXE @ ADDR0 235
 E01A TYPE 0x40 236
 E01B TYPE 0x60 236
 E02 MACHINE CHK 236
 E03A DSI HASH L 236
 E03B DSI HASH S 236
 E03C DSI BAT PL 237
 E03D DSI BAT PS 237
 E03E DSI CXIWX 237
 E03F DSI CXOWX 237
 E03G DSI ECXIWX 237
 E03H DSI ECXOWX 238
 E04A ISI NO TRA 238
 E04B ISI DIRECT 238
 E04C ISI PROTEC 238
 E06 NOT ALIGNED 238
 E07 ILLEGAL INS 239
 E08 FLOATINGPNT 239
 E12 SYSTEM CALL 239
 E13 TRACE INT 239
 E16 ITRANS MISS 239
 E17 DLOAD MISS 240
 E18 DSTORE MISS 240
 E19 BREAKPOINT 240
 E20 SYS MANAGE 240
 E30 DEBUGGER 240
 E31A EVENT 0 BP 241
 E31B EVENT 1 BP 241
 E31C EVENT 2 BP 241
 E31D EVENT 3 BP 241
 E31E EVENT 4 BP 241
 E31F EVENT 5 BP 242
 E31G EVENT 6 BP 242
 E31H EVENT 7 BP 242
 E32A CND 0 BP 242
 E32B CND 1 BP 242
 E32C CND 2 BP 243
 E32D CND 3 BP 243
 E32E CND 4 BP 243
 E32F CND 5 BP 243
 E32G CND 6 BP 243
 E32H CND 7 BP 244
 E33 WRITE BP 244
 E34 TRACE CMLPT 244
 E99 UNKNOWN INT 244
 ENERGY SAVER MODE
 ACTIVE 244
 error 221
 ERROR: DC PROGRAM NOT
 VALID 245
 ERROR: EC STOPPED AT STATE
 XXXX 245
 fault 221
 FREEFORM OFF 245
 FREEFORM ON:OFF HOLD KEY @
 PWRUP 245
 H/B CONTROL MODE 246
 H00: PCI SLOT ? 245
 H01: PCI J12 245
 H02: PCI J13 245
 HAMMER COIL BAD 246
 HMR BANK NOT INSTALLED 246
 ILL INST ACCSS* 246
 INCOMPAT E-NET 246
 INTAKE FAN FAULT 246

Messages (continued)

INTERRUPT UNUSED VECTOR
00 246
LOADING PROGRAM FROM PORT
XX% 246
LOADING PROGRAM INTO
FLASH 246
NOT READY 246
ONLINE CU TIMED OUT 247
OPERATOR MENU 247
OPERATOR MENU LOCKED 247
OPERATOR MENU
UNLOCKED 247
P00 ERROR:SYSTEM FAULT 247
P05 DIAGNOSTIC TEST
PASSED 247
P17 SECURITY VIOLATION 247
PA1 SELECTED 247
PA2 SELECTED 247
PAP FD DRVR CIR* 247
PRINTER UNDER REMOTE
CONTROL 247
QUEUE OVERRUN 247
READY 247
RESETTING...PLEASE WAIT 247
RESTORING BOOT CODE 247
RIBBON INK OUT 247
SECURITY CODE VIOLATION 248
SECURITY KEY NOT
DETECTED 248
SENSOR CALIBRATION
PASSED 248
SERVICE MENU 248
SF ERROR 248
SHUT DRVR CIR* 248
SHUTL OVR SPEED* 248
SHUTTLE STALL 248
SHUTTLE TYPE NOT
SUPPORTED* 248
STACK UNDERFLOW* 248
TABLE MISMATCH DOWNLOAD
AGAIN 248
TCP PORT BUSY 249
TESTING HARDWARE / PLEASE
WAIT 249
TOP OF FORM SET 249
TRANSPORT CALIBRATION
COMPLETE 249
WAITING FOR ETHERNET
ADAPTER 249
Midline PY
Code V Configuration menu
Graphics Option 161
Minimum Transfer Rate
Wireless Parameters menu 110
Mono/Dual Case
3270 Interface menu 90
Coax Interface menu 72
IGP Emulation menu 153
MVS host system, attach printer 277
MVS/JES2, installation types 277

N

Name Custom Sets 57

Nest Serv Type

Adapter Parameters Submenu
Network Setup menu 101
NetBIOS Protocol
Adapter Parameters Submenu
Network Setup menu 101
Ethernet Parameters Submenu
Network Setup menu 106
Network Setup menu 98
Adapter Address Submenu 99
DHCP 100
Gateway Address 99
IP Address 99
MAC Address 99
Subnet Mask 99
Adapter Parameters Submenu 100
ASCII Data Port Number 102
Buffer Size in Kilobytes 101
Ethernet Hotport 103
Ethernet Speed 102
IPDS Data Port Number 102
Job Control 102
Keep Alive Timer 102
Nest Serv Type 101
NetBIOS Protocol 101
Novell Frame 101
Novell Protocol 101
Report Status 103
Timeout 103
Trickle Time 103
Ethernet Address Submenu 104
DHCP 105
Gateway Address 104
IP Address 104
MAC Address 104
Subnet Mask 104
Ethernet Parameters Submenu 105
ASCII Data Port Number 106
Buffer Size in Kbytes 106
Ethernet Hotport 107
Ethernet Speed 107
IPDS Data Port Number 106
Job Control 107
Keep Alive Timer 106
NetBIOS Protocol 106
Timeout 107
Wireless Address Menu 108
DHCP 108
Gateway Address 108
IP Address 108
MAC Address 108
Subnet Mask 108
Nibble Mode, IEEE 1284 Parallel
Interface 202
noise level, acoustic 256
Non-SNA attachment 286
NOT READY 246
notices 289
Novell Frame
Adapter Parameters Submenu
Network Setup menu 101
Novell Protocol
Adapter Parameters Submenu
Network Setup menu 101

O

OCR font density, Printer Control
menu 50
Off Page Errors
Code V Configuration menu
Error Handling 163
One char enquiry
RS-232 197
RS-422 197
One Char Enquiry
Serial Interface menu 130
Online
Dataproducts Parallel Interface
Signals 201
PC Parallel Interface Signals 199
ONLINE CU TIMED OUT 247
Operating modes, IEEE 1284 Parallel
Interface 202
Operation Mode
Wireless Parameters menu 110
OPERATOR MENU 247
OPERATOR MENU LOCKED 247
OPERATOR MENU UNLOCKED 247
Operator panel 23
Operator Print Tests menu 189
Adapter Test Page 190
All E's 190
All E's + FF 190
All H's 190
Ethernet Test Page 190
Print Error Log 189
Printer Demonstration 189
Ripple Print 190
Underlines 190
Optimized Ratio
IGP Emulation menu 155
Optional features, printer 7
ordering ribbons 251
Output control 6
Override host
Twinax Interface menu 64
Override Host
3270 Interface menu 92
5250 Interface menu 84
Coax Interface menu 73
Override Host (Emulation Configuration)
IPDS Configuration menu 138
Overstrike
pSeries Emulation menu 174
Serial Matrix Emulation menu 180
Overview, printer models 1

P

P00 ERROR:SYSTEM FAULT 247
P05 DIAGNOSTIC TEST PASSED 247
P17 SECURITY VIOLATION 247
PA1
Coax Interface menu 69
PA1 SELECTED 247
PA2
Coax Interface menu 70
PA2 SELECTED 247
Page Format
ANSI menu
Auto LF 147

- Page Format *(continued)*
 - ANSI menu *(continued)*
 - Barcode Darkmode 149
 - BC Check Digit 149
 - Character Set 148
 - Define CR Code 147
 - Define LF Code 148
 - ESC c Sequence 148
 - ETX/ACK (TBD) 150
 - Form Length 146
 - Form Width 146
 - Margins 146
 - Pos. on BC/OvrSz 149
 - Printer Select 148
 - Private Mode 149
 - PUM Default 149
 - Received CR 148
 - Received DEL 149
 - Reset Command 148
 - Truncate PI Slew 149
- Panel, operator 23
- PAP FD DRVR CIR* 247
- Paper Empty (PE), PC Parallel Interface Signals 199
- Paper Instruction (PI)
 - Dataproducts Parallel Interface Signals 201
 - PC Parallel Interface Signals 199
- Paper jam detection, Printer Control menu 48
- paper, specifications 254
- Parallel Hotport
 - Parallel Interface menu 118
- Parallel Interface menu 117
 - Dataproducts 117
 - IEEE 1284 117
 - Interface Type 117
 - Parallel Hotport 118
 - PC Parallel 117
 - PC Parallel menu
 - Auto Trickle 121
 - Buffer Size in Kilobytes 121
 - Busy on Strobe 120
 - Data Bit 8 119
 - Data Polarity 120
 - Latch Data On 120
 - Prime Signal 120
 - Response Polarity 120
 - Strobe Polarity 120
 - TOF Action at Prime Signal 121
 - Trickle Time 121
 - PC Parallel Menu 119
 - Report Status 118
 - Timeout 118
 - Trickle Time 118
- Parallel Interface, Dataproducts 200
- Parameters
 - change 30
 - Code V 156
 - IGP 150
 - IPDS 135
 - printing the configuration 29
- Parity
 - Serial Interface menu 129
- Parity Error
 - Dataproducts Parallel Interface Signals 201
- PC Parallel
 - Parallel Interface menu 117
- PC Parallel Interface 198
- PC Parallel Interface Configuration 199
- PC Parallel Interface Signals 199
 - Acknowledge 199
 - Busy 199
 - Data Lines 1 through 8 199
 - Data Strobe 199
 - Online 199
 - Paper Empty (PE) 199
 - Paper Instruction (PI) 199
- PC Parallel menu
 - Dataproducts menu 122
 - Auto Trickle 124
 - Buffer Size in Kbytes 123
 - Data Bit 8 122
 - Data Polarity 123
 - Data Request Polarity 123
 - PI Ignored 123
 - Strobe Polarity 123
 - Trickle Time 124
 - Parallel Interface menu
 - Auto Trickle 121
 - Buffer Size in Kilobytes 121
 - Busy on Strobe 120
 - Data Bit 8 119
 - Data Polarity 120
 - Latch Data On 120
 - Prime Signal 120
 - Response Polarity 120
 - Strobe Polarity 120
 - TOF Action at Prime Signal 121
 - Trickle Time 121
- PC Parallel Menu
 - Parallel Interface menu 119
- Perforation Skip
 - Print Format menu 188
- physical unit (PU) types and examples 286
 - PU type 2 286
 - PU type 2.1 287
- physical unit type 286
- PI Control
 - Code V Configuration menu 165
 - Host PI 165
 - PI Slew Range 166
 - Printer PI 165
- PI Ignored
 - Dataproducts menu
 - PC Parallel menu 123
 - PI Slew Range
 - Code V Configuration menu
 - PI Control 166
 - IGP Emulation menu 152
- Poll character
 - RS-232 197
 - RS-422 197
- Poll Character
 - Serial Interface menu 130
- Port Type
 - 3270 Interface menu 92
 - 5250 Interface menu 85
 - Coax Interface menu 74
 - Twinax Interface menu 65
- Pos. on BC/OvrSz
 - ANSI menu
 - Page Format 149
- Postnet Barcode Width
 - IPDS Configuration menu 140
- power consumption 257
- Power Management
 - Wireless Parameters menu 111
- Power On ^F
 - Code V Configuration menu
 - SFCC and Power On 159
- Power On ^PY
 - Code V Configuration menu
 - SFCC and Power On 159
- Power On ^X
 - Code V Configuration menu
 - SFCC and Power On 159
- Power on configuration, change 37
- Power On IGP
 - IGP Emulation menu 154
- Power on state, Printer Control menu 48
- Power On Time
 - Printer Information menu 191
- Power requirements 13
- Power stacker, Printer Control menu 52
- Preamble
 - Wireless Parameters menu 111
- Prime Signal
 - Parallel Interface menu
 - PC Parallel menu 120
- Print Attributes
 - Print Format menu 186
 - Italic Print 186
 - Proportional Spacing 186
 - Slashed Zero 187
 - Text Position 187
 - UTF-8 187
- Print character table
 - Coax Interface menu 69
 - Twinax Interface menu 60
- Print Character Table
 - 3270 Interface menu 89
 - 5250 Interface menu 82
 - Print Format menu 186
- Print custom set values, Configuration Management menu 57
- Print direction, Printer Control menu 47
- Print Error Log
 - Operator Print Tests menu 189
- Print Error Log test 215
- Print Format
 - Emulation Configuration menu 134
- Print Format menu 181
 - Characters per inch 182
 - Forms length
 - Forms Length In Inches 185
 - Forms Length In Lines 185
 - Forms Length In MM 185
 - Forms Width 183
 - Forms Width In Characters 183
 - Forms Width In Inches 183
 - Forms Width In MM 183
 - Lines Per Inch 182
 - Margins 187
 - Bottom Margin 188
 - Left Margin 188
 - Right Margin 188

- Print Format menu (*continued*)
 - Perforation Skip 188
 - Print Attributes 186
 - Italic Print 186
 - Proportional Spacing 186
 - Slashed Zero 187
 - Text Position 187
 - UTF-8 187
 - Print Character Table 186
 - Print Quality 186
 - Reset Command 188
 - Print language
 - Coax Interface menu 69
 - Twinax Interface menu 60
 - Print Language
 - 3270 Interface menu 89
 - 5250 Interface menu 82
 - Proprinter III XL Emulation menu 168
 - pSeries Emulation menu 173
 - Serial Matrix Emulation menu 179
 - Print Language (TCP/IP IPDS)
 - IPDS Configuration menu 137
 - Print Quality
 - Print Format menu 186
 - Print Strokes
 - Printer Information menu 192
 - Print text direction
 - Twinax Interface menu 64
 - Print Text Direction
 - 3270 Interface menu 91
 - 5250 Interface menu 84
 - Coax Interface menu 72
 - Print, current configuration 28
 - printer
 - cables 260
 - dimensions 255
 - interfaces 260
 - print rates 261
 - self-tests 215
 - specifications 251
 - weight 255
 - Printer
 - active versus saved configurations 20
 - attach to IBM System i or zSeries host system 273
 - attachment 11
 - component locations 16
 - configuration main menu 20
 - configuration overview 11, 19
 - configuration types 19
 - dimensions 14
 - emulations 5, 9
 - features 1
 - graphics enhancement 9
 - installation 11
 - interfaces 193
 - maintenance 10
 - models 1
 - operator panel 23
 - optional features 7
 - power requirements 13
 - program mode 27
 - protocols 9
 - self-tests, running 216
 - site requirements 13
 - standard capabilities 4
 - Printer address, Twinax Interface menu 60
 - printer configuration, change IBM System i 274
 - Printer Control menu 45
 - Display language 47
 - Eject/Restore 50
 - Energy saver timer 49
 - File system 51
 - Forms speed 48
 - Hex print mode 48
 - Interface selection 47
 - OCR font density 50
 - Paper jam detection 48
 - Power on state 48
 - Power stacker 52
 - Print direction 47
 - PTR setup option 51
 - Set platen at bottom of form 49
 - Shuttle timeout 49
 - Printer Demonstration
 - Operator Print Tests menu 189
 - Printer Demonstration test 215
 - Printer emulation
 - Twinax Interface menu 60
 - Printer Emulation Configuration
 - Emulation Configuration menu 134
 - Printer Emulation Configuration menu 166
 - Epson Emulation menu 169
 - Print Format menu 181
 - Proprinter III XL Emulation menu 167
 - pSeries Emulation menu 171
 - pSeries XQ Emulation menu 175
 - Serial Matrix Emulation menu 178
 - Printer Information menu 191
 - 11 Inch Pages 192
 - Installed Memory 191
 - Power On Time 191
 - Print Strokes 192
 - Printing Time 191
 - Printer PI
 - Code V Configuration menu
 - PI Control 165
 - Printer Select
 - ANSI menu
 - Page Format 148
 - Epson Emulation menu 170
 - Serial Matrix Emulation menu 180
 - printer self tests
 - All E's 215
 - All E's + FF (Form Feed) 215
 - All H's 215
 - Print Error Log 215
 - Printer Demonstration 215
 - Ripple Print 215
 - Underlines 215
 - PRINTER UNDER REMOTE CONTROL 247
 - printing speed 265
 - Printing Time
 - Printer Information menu 191
 - Printout, Hex code 217
 - Private Mode
 - ANSI menu
 - Page Format 149
 - Procedure, fault correction 221
 - Program mode 27
 - entering 28
 - locking 28
 - unlocking 27
 - Prop. Spacing (Proportional Spacing) ANSI menu
 - Font Attributes 145
 - Proportional Spacing
 - Print Format menu
 - Print Attributes 186
 - Proprinter III XL Emulation menu 167
 - 20 CPI Condensed 169
 - Alternate Character Set 168
 - Auto LF 168
 - Define CR Code (Carriage Return) 168
 - Define LF Code (Line Feed) 168
 - FF Valid At TOF 168
 - Print Language 168
 - Protect Custom Sets
 - Configuration Management menu 56
 - Protect custom sets, Configuration Management menu 56
 - Protocols 9
 - pSeries Emulation menu 171
 - Alternate Set 80-9F 174
 - Auto LF 173
 - Character Sets 173
 - Control Code 06 173
 - Control Code 08 173
 - Define CR Code (Carriage Return) 173
 - Define LF Code 174
 - EVFU Select 174
 - Overstrike 174
 - Print Language 173
 - Select SFCC 174
 - pSeries XQ Emulation menu 175
 - Auto LF 176
 - Compressed Print 176
 - Control Code 06 175
 - Define CR Code (Carriage Return) 176
 - Define LF Code (Line Feed) 176
 - Elong/Alt. Font 176
 - EVFU select 177
 - High Speed Print Mode 176
 - Slew Relative 177
 - Upper Case Select 177
 - PTR setup option, Printer Control menu 51
 - PU type 2 286
 - PU type 2.1 287
 - PUM Default
 - ANSI menu
 - Page Format 149
- ## Q
- QUEUE OVERRUN 247
- ## R
- rates, printing 261

- Ready
 - Dataproducts Parallel Interface Signals 201
- READY 247
- Recall custom set, Configuration Management menu 55
- Receive Data (RD), RS-232 195
- Received CR
 - ANSI menu
 - Page Format 148
- Received DEL
 - ANSI menu
 - Page Format 149
- remote control unit with Twinax interface, attach printer 276
- removing resistors 207
- Renew Lifetime
 - Wireless Kerberos menu 114
- Report Status
 - 5250 Interface menu 86
 - Adapter Parameters Submenu
 - Network Setup menu 103
 - Coax Interface menu 74
 - Parallel Interface menu 118
 - Serial Interface menu 132
 - Twinax Interface menu 66
- representative IBM products, summary 287
- Request to Send
 - RS-232 195
 - Serial Interface menu 130
- requirements
 - humidity 256
- Requirements
 - power 13
 - printer site 13
- Reset Command
 - ANSI menu
 - Page Format 148
 - Print Format menu 188
- Reset Kerberos Password
 - Wireless Kerberos menu 114
- Reset LEAP Password
 - Wireless LEAP menu 116
- Reset LEAP User
 - Wireless LEAP menu 116
- Reset SSID Name
 - Wireless Parameters menu 110
- Reset WEP Keys
 - Wireless Parameters menu 112
- RESETTING...PLEASE WAIT 247
- Resistor configurations, terminating resistors 206
 - installing 207
 - removing 207
- Response Polarity
 - Parallel Interface menu
 - PC Parallel menu 120
- RESTORING BOOT CODE 247
- RIBBON INK OUT 247
- ribbon, ordering 251
- ribbon, specifications 251
- Right Margin
 - Print Format menu
 - Margins 188
- Ripple Print
 - Operator Print Tests menu 190

- Ripple Print test 215
- Rotate Character Size
 - Code V Configuration menu
 - Graphics Option 161
- routine service
 - cleaning requirements 211
 - cleaning the inside of the cabinet 212
 - cleaning the outside of the cabinet 211
 - overview 211
- RS-232
 - 6500-v20 Models 194
 - Clear to Send (CTS) 195
 - Data Carrier Detect (DCD) 195
 - Data Set Ready (DSR) 195
 - Data Terminal Ready (DTR) 195
 - one char enquiry 197
 - poll character 197
 - Receive Data (RD) 195
 - Request to Send (RTS) 195
 - serial interface configuration 197
 - serial interface error handling 196
 - serial interface protocols 195
 - Transmit Data (TD) 195
- RS-232 and RS-422
 - serial interface protocols 196
- RS-232 Serial Interfaces 194
- RS-422
 - 6500 Models 195
 - one char enquiry 197
 - poll character 197
 - serial interface configuration 197
 - serial interface error handling 196
- RS-422 Serial Interfaces 194
- Running printer self-tests 216

S

- Save configuration 32
- Save current values, Configuration Management menu 56
- SCS Buffer Control
 - Coax Interface menu 71
- SECURITY CODE VIOLATION 248
- SECURITY KEY NOT DETECTED 248
- Select Character
 - Ignore Character
 - IGP Emulation menu 155
- Select Character 1
 - Code V Configuration menu
 - Character Filtering 164
- Select Character 2
 - Code V Configuration menu
 - Character Filtering 164
- Select Font
 - IGP Emulation menu 153
- Select Set
 - IGP Emulation menu 152
- Select SFCC
 - IGP Emulation menu 152
 - pSeries Emulation menu 174
- self-tests
 - printer 215
- self-tests, printer
 - All E's 215
 - All E's + FF (Form Feed) 215
 - All H's 215
- self-tests, printer (*continued*)
 - Print Error Log 215
 - Printer Demonstration 215
 - Ripple Print 215
 - Underlines 215
- SENSOR CALIBRATION PASSED 248
- Serial Hotport
 - Serial Interface menu 131
- Serial interface configuration
 - RS-232 197
 - RS-422 197
- Serial interface error handling
 - RS-232 196
 - RS-422 196
- Serial Interface menu 127
 - Baud Rate 128
 - Buffer Size in Kbytes 130
 - Data Bits 128
 - Data Protocol 128
 - Data Terminal Ready 129
 - Framing Errors 132
 - Interface Type 128
 - One Char Enquiry 130
 - Parity 129
 - Poll Character 130
 - Report Status 132
 - Request to Send 130
 - Serial Hotport 131
 - Stop Bits 128
 - Timeout 132
 - Trickle Time 131
- Serial interface protocols
 - RS-232 195
 - RS-232 and RS-422 196
- Serial Interfaces
 - RS-232 194
 - RS-422 194
- Serial Matrix Emulation menu 178
 - Alternate Set 80-9F 180
 - Auto LF 180
 - Character Sets 179
 - Control Code 06 179
 - Define CR Code (Carriage Return) 179
 - Define LF Code (Line Feed) 180
 - Overstrike 180
 - Print Language 179
 - Printer Select 180
- SERVICE MENU 248
- Set platen at bottom of form, Printer Control menu 49
- SF ERROR 248
- SFCC and Power On
 - Code V Configuration menu 158
 - Code V SFCC 158
 - Power On ^F 159
 - Power On ^PY 159
 - Power On ^X 159
- SHUT DRVR CIR* 248
- SHUTL OVR SPEED* 248
- SHUTTLE STALL 248
- Shuttle timeout, Printer Control menu 49
- SHUTTLE TYPE NOT SUPPORTED* 248
- Signal Strength
 - Wireless Parameters menu 110

- Signals
 - Dataproducts Parallel Interface 201
 - IEEE 1284 Parallel Interface 203
 - PC Parallel Interface 199
- Site requirements 13
- Skip Command Prefix
 - IGP Emulation menu 154
- Slash 0
 - IGP Emulation menu 153
- Slashed Zero
 - ANSI menu
 - Font Attributes 145
 - Code V Configuration menu
 - Graphics Option 160
 - Print Format menu
 - Print Attributes 187
- Slew Relative
 - pSeries XQ Emulation menu 177
- SNA attachment 285
- specifications
 - cables 260
 - interfaces 260
 - labels 255
 - paper 254
 - printer 251
 - ribbon 251
 - temperature 256
- speed, printing 265
- SSID Name
 - Wireless Parameters menu 110
- STACK UNDERFLOW* 248
- Standard capabilities 4
 - built-in diagnostic tools 7
 - graphics 7
 - host computer interfaces 4
 - output control 6
 - printer emulations 5
 - vertical formatting 7
- Stop Bits
 - Serial Interface menu 128
- Strobe Polarity
 - Dataproducts menu
 - PC Parallel menu 123
 - Parallel Interface menu
 - PC Parallel menu 120
- Subnet Mask
 - Adapter Address Submenu
 - Network Setup menu 99
 - Ethernet Address Submenu
 - Network Setup menu 104
 - Wireless Address Menu
 - Network Setup menu 108

T

- TABLE MISMATCH DOWNLOAD AGAIN 248
- TCP PORT BUSY 249
- temperature specifications 256
- Terminating resistor configurations 206
- TESTING HARDWARE / PLEASE WAIT 249
- Text Position
 - Print Format menu
 - Print Attributes 187
- theory, line matrix printing 263

- Ticket Lifetime
 - Wireless Kerberos menu 114
- Timeout
 - 3270 Interface menu 93
 - 5250 Interface menu 86
 - Adapter Parameters Submenu
 - Network Setup menu 103
 - Coax Interface menu 74
 - Ethernet Parameters Submenu
 - Network Setup menu 107
 - Parallel Interface menu 118
 - Serial Interface menu 132
 - Twinax Interface menu 66
- TOF Action at Prime Signal
 - Parallel Interface menu
 - PC Parallel menu 121
- TOP OF FORM SET 249
- Translate Table
 - Compatibility Options 73
- Transmit Data (TD), RS-232 195
- Transmit Power
 - Wireless Parameters menu 111
- TRANSPORT CALIBRATION COMPLETE 249
- Trickle Time
 - Adapter Parameters Submenu
 - Network Setup menu 103
 - Dataproducts menu
 - PC Parallel menu 124
 - IEEE 1284 menu 126
 - Parallel Interface menu 118
 - PC Parallel menu 121
 - Serial Interface menu 131
- True Vertical 1/10
 - Code V Configuration menu
 - Graphics Option 160
- Truncate Off Page Alpha
 - Code V Configuration menu
 - Graphics Option 160
- Truncate PI Slew
 - ANSI menu
 - Page Format 149
- Twinax Interface menu 58
 - Active print language 60
 - C/T Hotport 65
 - Cancel buffers 61
 - Early print complete 61
 - Format control 64
 - Hex print mode 65
 - Hex transparent control 62
 - LAC approximation 63
 - Load alternate character option 63
 - Maximum printable width 65
 - Override host 64
 - Port Type 65
 - Print character table 60
 - Print language 60
 - Print text direction 64
 - Printer address 60
 - Printer emulation 60
 - Report Status 66
 - Timeout 66
 - Undefined character reporting 63
 - Undefined character substitution 63
- Typeface
 - ANSI menu
 - Font Attributes 144

U

- Undefined Char Reporting
 - 5250 Interface menu 83
- Undefined Char Sub
 - 5250 Interface menu 84
 - Coax Interface menu 72
- Undefined Char Substitution
 - 3270 Interface menu 91
- Undefined character reporting, Twinax Interface menu 63
- Undefined character substitution
 - Twinax Interface menu 63
- Undefined Character Substitution (TCP/IP IPDS)
 - IPDS Configuration menu 137
- Underlines
 - Operator Print Tests menu 190
- Underlines test 215
- Unlocking, program mode 27
- UPC Descenders
 - Code V Configuration menu
 - Graphics Option 161
 - IGP Emulation menu 154
- UPC/EAN Barcode HRI
 - IPDS Configuration menu 140
- Upper Case Select
 - pSeries XQ Emulation menu 177
- User Defined Codes
 - 3270 Interface menu 90
 - 5250 Interface menu 83
 - Coax Interface menu 71
- UTF-8
 - Print Format menu
 - Print Attributes 187

V

- Vertical formatting 7
- VM host system, printer attach 285
- volume, input 257

W

- WAITING FOR ETHERNET ADAPTER 249
- weight, printer 255
- WEP Key BYTE1 through BYTE13
 - Wireless Parameters menu 112
- WEP Key Format
 - Wireless Parameters menu 112
- WEP Key Width
 - Wireless Parameters menu 112
- Width Limit
 - Code V Configuration menu
 - Graphics Option 162
- Wireless Address Menu
 - Network Setup menu 108
 - DHCP 108
 - Gateway Address 108
 - IP Address 108
 - MAC Address 108
 - Subnet Mask 108
- Wireless Kerberos menu 113
 - Clock Skew 114
 - KDC Port Number 114
 - Kerberos Enable 113

Wireless Kerberos menu (*continued*)
 Kerberos Password 114
 Renew Lifetime 114
 Reset Kerberos Password 114
 Ticket Lifetime 114
Wireless LEAP menu 115
 Authentication Method 115
 LEAP Password 116
 LEAP Username 116
 Reset LEAP Password 116
 Reset LEAP User 116
Wireless Parameters menu 109
 Antenna Diversity 111
 Channel 110
 Default WEP Key 111, 112
 International Mode 111
 Minimum Transfer Rate 110
 Operation Mode 110
 Power Management 111
 Preamble 111
 Reset SSID Name 110
 Reset WEP Keys 112
 Signal Strength 110
 SSID Name 110
 Transmit Power 111
 WEP Key BYTE1 through
 BYTE13 112
 WEP Key Format 112
 WEP Key Width 112

Z

zSeries host system
 attach system 273
zSeries, attach system 273

Printed in USA

S550-1002-00

